

vistosi

2019-1 Temporary
Price List / Euro

 **Vistosi**

Materiali / Materials

Colori vetro / Glass colors

AA	ametista chiara	<i>light amethyst</i>
AM	ambra	<i>amber</i>
AT	ametista	<i>amethyst</i>
BC	bianco	<i>white</i>
CR	cristallo	<i>crystal</i>
FU	fumè	<i>smoky</i>
GR	grigio	<i>grey</i>
NE	nero	<i>black</i>
SB	sabbia	<i>sand</i>
SE	seta	<i>silk</i>
TB	terra bruciata	<i>burned earth</i>
VA	verde antico	<i>old green</i>

Finiture vetro / Glass finishes

.. / AG	.. / argento	<i>.. / silver</i>
.. / BC	.. / bianco	<i>.. / white</i>
.. / BO	.. / "bolle"	<i>.. / "bubbles"</i>
.. / BR	.. / bronzo	<i>.. / bronze</i>
.. / BT	.. / "balloton"	<i>.. / "balloton"</i>
.. / CM	.. / metallizzato	<i>.. / metallized</i>
.. / DI	.. / diffusore lucido	<i>.. / glossy diffuser</i>
.. / FO	.. / foglia oro	<i>.. / gold leaf</i>
.. / LU	.. / lucido	<i>.. / glossy</i>
.. / MF	.. / metallizzato sfumato	<i>.. / shaded metallized</i>
.. / MU	.. / "murrina"	<i>.. / "murrina"</i>
.. / NE	.. / nero	<i>.. / black</i>
.. / OR	.. / oro	<i>.. / gold</i>
.. / PU	.. / "pulegoso"	<i>.. / "pulegoso"</i>
.. / RA	.. / rame	<i>.. / copper</i>
.. / RI	.. / rigadin	<i>.. / striped glass</i>
.. / SF	.. / sfumato	<i>.. / shaded</i>
.. / ST	.. / satinato	<i>.. / matt</i>
.. / TR	.. / trasparente	<i>.. / transparent</i>

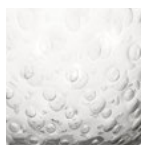

.. / BO



.. / BT



.. / PU

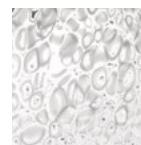

.. / MU









Finiture delle parti metalliche / *Metal parts finishes*

AB	alluminio bronzo	<i>bronze aluminium</i>
AS	acciaio specchiato	<i>mirrored steel</i>
AVS	acciaio satinato verniciato	<i>matt steel</i>
BC	bianco lucido	<i>glossy white</i>
BD	bianco opaco 2	<i>matt white 2</i>
BH	bronzo lucido	<i>glossy bronze</i>
BHS	bronzo satinato	<i>matt bronze</i>
BKL	ottone lucido	<i>glossy brass 1</i>
BKS	oro satinato 3	<i>matt gold 3</i>
BO	bianco opaco 1	<i>matt white 1</i>
BP	bianco opaco 3	<i>matt white 3</i>
BR	bronzo opaco	<i>matt bronze</i>
BS	bronzo satinato	<i>matt bronze</i>
BV	bronzo lucido	<i>glossy bronze</i>
CR	cromo lucido	<i>glossy chrome</i>
C-G	cromo - cavo grigio	<i>chrome - grey cable</i>
GR	grigio	<i>grey</i>
MA	marrone	<i>brown</i>
NE	nero opaco 1	<i>matt black 1</i>
NEL	nero lucido	<i>glossy black</i>
NEO	nero opaco 2	<i>matt black 2</i>
NI	nickel satinato	<i>satin nickel</i>
NL	nickel lucido	<i>glossy nickel</i>
NN	nickel nero	<i>black nickel</i>
NNS	nikel nero satinato	<i>matt black nickel</i>
NO	nickel opaco	<i>matt nickel</i>
N-N	nero - cavo nero	<i>black - black cable</i>
OA	oro rosa satinato	<i>matt pink gold</i>
OG	ottone lucido 2	<i>glossy brass 2</i>
OP	oro satinato 1	<i>matt gold 1</i>
OR	oro lucido	<i>glossy gold</i>
OS	oro satinato 2	<i>matt gold 2</i>
OT	ottone anticato	<i>antique brass</i>
OTL	ottone	<i>brass</i>
OTS	ottone satinato	<i>matt brass</i>
RA	rame lucido	<i>glossy copper</i>
RAS	rame satinato 1	<i>matt brass 1</i>
RAV	rame satinato 2	<i>matt brass 2</i>

Altre finiture / *Other materials*

LFN	legno frassino nero	<i>black ash wood</i>
LFR	legno frassino naturale	<i>natural ash wood</i>
LNO	legno noce naturale	<i>natural walnut wood</i>

Legenda / Key

	<p>CLASSE 1 Isolamento funzionale in ogni parte, provvisto di messa a terra, o con morsetto se fisso o con conduttore e relativa spina con contatto di terra, se mobile.</p>	<p>CLASS 1 <i>Functional insulation in every part and ground terminal or clamp if the unit is fixed, or with conductor and relative plug with ground contact if the unit is mobile.</i></p>
	<p>CLASSE 2 Doppio isolamento e/o isolamento rinforzato in ogni parte e senza dispositivi di messa a terra.</p>	<p>CLASS 2 <i>Double insulation and/or reinforced insulation in every part and without ground devices.</i></p>
	<p>CLASSE 3 Apparecchio in cui la protezione contro la scossa elettrica si basa sull'alimentazione a bassissima tensione di sicurezza (SELV) e in cui non si producono tensioni superiori alla stessa.</p>	<p>CLASS 3 <i>Luminaire in which protection against electric shock relies on supply at safety extra-low voltage (SELV) and in which voltages higher than those of SELV are not generated.</i></p>
	<p>Certificato di "Conformità Europea", indica che il prodotto è conforme alle norme di sicurezza Europee.</p>	<p><i>"European Conformity" marking, which indicates that the product complies with the European safety standards.</i></p>
	<p>È il massimo delle certificazioni di prodotto vigenti in Europa. Per ottenere questo certificato, il prodotto deve superare i test di sicurezza Europei, ma anche i test specifici richiesti da tutti gli stati membri.</p>	<p><i>It is the high quality European certification for products. In order to obtain it, the product must pass the European security tests as well as the specific tests required by each Member State.</i></p>
	<p>Certificato di conformità del prodotto alle normative di sicurezza elettro-tecnica della Federazione Russa.</p>	<p><i>Certification indicating products that conform to the electro-technical safety regulations of the Russian Federation.</i></p>
	<p>Certificato di conformità del prodotto alle normative di sicurezza elettro-tecnica della Cina.</p>	<p><i>Certification indicating products that conform to the electro-technical safety regulations of China.</i></p>
	<p>Certificato di conformità del prodotto alle normative di sicurezza elettro-tecnica del Giappone. Disponibile solo su richiesta e fornito da Doi&Co. Luminabella Div.</p>	<p><i>Certification indicating products that conform to Japan's electro-technical safety regulations. Available only on request and supplied by Doi & Co. Luminabella Div.</i></p>
	<p>Certificato internazionale di sicurezza elettro-tecnica di prodotto, riconosciuto da oltre 50 Paesi.</p>	<p><i>International Certification of electro-technical product safety, recognized by over 50 countries.</i></p>
	<p>Certificato di conformità del prodotto alle normative di sicurezza elettro-tecnica degli Stati Uniti e del Canada. Disponibile per i mercati di riferimento.</p>	<p><i>Certification of product conformity to the electro-technical safety regulations of the United States and Canada. Available for the specific markets.</i></p>
	<p>Simbolo che indica che l'apparecchio è conforme alle linee guida dell'Americans with Disabilities Act (ADA).</p>	<p><i>Symbol indicating that the device complies with the guidelines of the Americans with Disabilities Act (ADA).</i></p>
IPXX	<p>Grado di protezione dell'apparecchio ai solidi-liquidi.</p>	<p><i>Level of protection of electronic equipments against solids and liquids.</i></p>
	<p>Quando il simbolo appare sull'etichetta posta sul prodotto significa che lo stesso è predisposto per il montaggio diretto su superfici normalmente infiammabili.</p>	<p><i>When the symbol appears on the label placed on the product it means that the product itself is pre-disposed for being mounted on normally flammable surfaces.</i></p>
	<p>Quando il simbolo appare sull'etichetta posta sul prodotto significa che lo stesso NON è predisposto per il montaggio diretto su superfici normalmente infiammabili.</p>	<p><i>When the symbol appears on the label placed on the product it means that the product itself is NOT pre-disposed for being mounted on normally flammable surfaces.</i></p>
DIM 1	<p>Lampada predisposta per essere dimmerata con un sistema in "taglio di fase". Attenzione, in caso di utilizzo di lampadine retrofit a led, assicurarsi che queste siano di tipo dimmerabile.</p>	<p><i>Lamp designed to be dimmed with a "phase cut" system. Attention: when using retrofit LED bulbs, make sure that they are dimmable.</i></p>
DIM 2	<p>Lampada predisposta per essere dimmerata con un sistema in "taglio di fase". Attenzione, assicurarsi che il sistema supporti i bassi wattaggi del led.</p>	<p><i>Lamp designed to be dimmed with a "phase cut" system. Attention: make sure that the system supports LED low wattages.</i></p>
DIM 3	<p>Lampada predisposta per essere dimmerata con un sistema in 1..10 e PUSH.</p>	<p><i>Lamp designed to be dimmed with a system in 1..10 and PUSH.</i></p>
DIM 4	<p>Dimmer incluso.</p>	<p><i>Dimmer included.</i></p>
DIM 5	<p>Lampada predisposta per essere dimmerata con un sistema DALI. Disponibile su richiesta e solo su prodotti che tecnicamente ne consentono l'installazione.</p>	<p><i>Lamp designed to be dimmed with a DALI system. Available on request and only for products that technically allow its installation.</i></p>
DIM 6	<p>Lampada predisposta per essere dimmerata con un sistema DMX. Disponibile su richiesta e solo su prodotti che tecnicamente ne consentono l'installazione.</p>	<p><i>Lamp designed to be dimmed with a DMX system. Available on request and only for products that technically allow its installation.</i></p>
NO DIM	<p>Lampada non dimmerabile.</p>	<p><i>Not-dimmable lamp.</i></p>

Materiali / Materials

Colori vetro / <i>Glass colors</i>	2
Finiture vetro / <i>Glass finishes</i>	2
Finiture delle parti metalliche / <i>Finishes of metal parts</i>	2
Altri materiali / <i>Other materials</i>	2

Legenda / Key

Listino prezzi News 2019 / <i>Price list News 2019</i>	5
Condizioni di vendita / <i>Sales conditions</i>	11

Versioni LED / LED version

LED A



LED B



caratteristiche / features

vita media / average lifetime	ore / h
flusso luminoso / luminous flux	lm
temperatura colore / color temperature	°K
CRI	Ra
efficacia / efficiency	lm/W
angolo ottico / optical angle	°
tensione media / average tension	V
consumo / power consumption @500mA	W
dimmerazione / dimming	DIM

USA & Canada

40.000
600
2.700
90
120
120
10
5
1-10 V / Push

40.000
600
2.700
90
120
120
10
5
1-10 V / Push

USA & Canada

40.000
600
2.700
90
120
120
10
5
1-10 V / Push

40.000
600
2.700
90
120
120
10
5
1-10 V / Push

LED C



LED D



caratteristiche / features

vita media / average lifetime	ore / h
flusso luminoso / luminous flux	lm
temperatura colore / color temperature	°K
CRI	Ra
efficacia / efficiency	lm/W
angolo ottico / optical angle	°
tensione media / average tension	V
consumo / power consumption @500mA	W
dimmerazione / dimming	DIM

USA & Canada

40.000
600
2.700
90
120
120
10
5
1-10 V / Push

40.000
600
2.700
90
120
120
10
5
1-10 V / Push

USA & Canada

40.000
600
2.700
90
120
120
10
5
1-10 V / Push

40.000
600
2.700
90
120
120
10
5
1-10 V / Push

Versioni LED / LED version

LED E



LED F



caratteristiche / features

USA & Canada

USA & Canada

vita media / average lifetime	ore / h	40.000	40.000	40.000	40.000	40.000
flusso luminoso / luminous flux	lm	850	850	1.650	1.650	1.650
temperatura colore / color temperature	°K	3.000	3.000	3.000	3.000	3.000
CRI	Ra	80	80	80	80	80
efficacia / efficiency	lm/W	140	140	130	130	130
angolo ottico / optical angle	°	115	115	115	115	115
tensione media / average tension	V	12	12	25	25	25
consumo / power consumption @500mA	W	6	6	12,5	12,5	12,5
dimmerazione / dimming	DIM	1-10 V / Push	1-10 V / Push	1-10 V / Push	1-10 V / Push	1-10 V / Push

LED G



LED I



caratteristiche / features

USA & Canada

USA & Canada

vita media / average lifetime	ore / h	30.000	30.000	20.000	20.000	20.000
flusso luminoso / luminous flux	lm	2.850	2.850	1.120	1.300	1.300
temperatura colore / color temperature	°K	3.000	3.000	3.000	3.000	3.000
CRI	Ra	80	80	80	80	80
efficacia / efficiency	lm/W	145	145	110	75	75
angolo ottico / optical angle	°	115	115	115	115	115
tensione media / average tension	V	39	39	230	120	120
consumo / power consumption @500mA	W	19,5	19,5	10	17,5	17,5
dimmerazione / dimming	DIM	1-10 V / Push	1-10 V / Push	Phase cut	Phase cut	Phase cut

LED J



LED N



caratteristiche / features

vita media / average lifetime	ore / h
flusso luminoso / luminous flux	lm
temperatura colore / color temperature	°K
CRI	Ra
efficacia / efficiency	lm/W
angolo ottico / optical angle	°
tensione media / average tension	V
consumo / power consumption @500mA	W
dimmerazione / dimming	DIM

USA & Canada

20.000
1.120
3.000
80
115
115
230
10
Phase cut

20.000
1.300
3.000
80
75
115
120
17,5
Phase cut

USA & Canada

20.000
1.120
3.000
80
110
115
230
10
Phase cut

20.000
1.300
3.000
80
75
115
120
17,5
Phase cut

LED O



LED R



caratteristiche / features

vita media / average lifetime	ore / h
flusso luminoso / luminous flux	lm
temperatura colore / color temperature	°K
CRI	Ra
efficacia / efficiency	lm/W
angolo ottico / optical angle	°
tensione media / average tension	V
consumo / power consumption @500mA	W
dimmerazione / dimming	DIM

USA & Canada

30.000
2.850
3.000
80
145
115
39
19,5
1-10 V / Push

35.000
2.850
3.000
80
145
115
39
19,5
1-10 V / Push

USA & Canada

30.000
1.650
3.000
80
130
115
25
12,5
1-10 V / Push

30.000
1.650
3.000
80
130
115
25
12,5
1-10 V / Push

Versioni LED / LED version

LED T



LED V



caratteristiche / features

USA & Canada

vita media / average lifetime	ore / h	30.000
flusso luminoso / luminous flux	lm	1.650
temperatura colore / color temperature	°K	3.000
CRI	Ra	80
efficacia / efficiency	lm/W	130
angolo ottico / optical angle	°	115
tensione media / average tension	V	25
consumo / power consumption @500mA	W	12,5
dimmerazione / dimming	DIM	1-10 V / Push

30.000
1.650
3.000
80
130
115
25
12,5
1-10 V / Push

USA & Canada

30.000	30.000
2.850	2.850
3.000	3.000
80	80
145	145
115	115
39	39
19,5	19,5
1-10 V / Push	1-10 V / Push

LED X



caratteristiche / features

USA & Canada

vita media / average lifetime	ore / h	30.000
flusso luminoso / luminous flux	lm	2.850
temperatura colore / color temperature	°K	3.000
CRI	Ra	80
efficacia / efficiency	lm/W	145
angolo ottico / optical angle	°	115
tensione media / average tension	V	39
consumo / power consumption @500mA	W	19,5
dimmerazione / dimming	DIM	1-10 V / Push

30.000
2.850
3.000
80
145
115
39
19,5
1-10 V / Push

finitura vetro / glass finish

finitura struttura / frame finish

24PEARLS

design Romani Saccani Architetti Associati 2009



BC/CM

CR

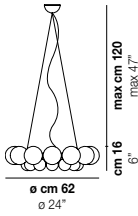

24PEARLS SP

codice / code	vetro / glass	struttura / frame	elettrificazione / lamping	CL. IP	EU cert.	International cert.	dimmer	€
24PEARLSSP	BC/CM	CR	G9 12×33W G9	⊥ IP20	CE	EREC	DIM 1	1.750,00

finitura vetro / glass finish

finitura struttura / frame finish

ALEGA

design Vico Magistretti 1970



BC/CR

CR

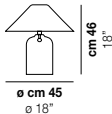

ALEGA LT

codice / code	vetro / glass	struttura / frame	elettrificazione / lamping	CL. IP	EU cert.	International cert.	dimmer	€
ALEGALT	BC/CR	CR	E14 3×46W E14	⊥ IP20	CE	EREC	DIM 4A	550,00

finitura vetro / glass finish

finitura struttura / frame finish

ARIA

design Giovanni Barbato 2017



BC/CM

BC/RA

BC/SF

NL

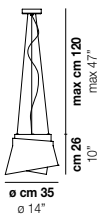

ARIA SP

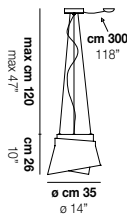

ARIA SP D1

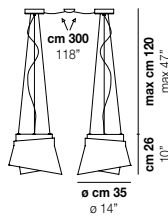

ARIA SP D2

codice / code	vetro / glass	struttura / frame	elettrificazione / lamping	CL. IP	EU cert.	International cert.	dimmer	€
ARIA SP	BC/CM BC/RA	NL	E27 1×77W E27	⊥ IP20	CE	EREC	DIM 1	680,00
ARIA SP	BC/SF	NL	E27 1×77W E27	⊥ IP20	CE	EREC	DIM 1	620,00
ARIA SP D1	BC/CM BC/RA	NL	E27 1×77W E27	⊥ IP20	CE	EREC	DIM 1	680,00
ARIA SP D1	BC/SF	NL	E27 1×77W E27	⊥ IP20	CE	EREC	DIM 1	610,00
ARIA SP D	BC/CM BC/RA	NL	E27 2×77W E27	⊥ IP20	CE	EREC	DIM 1	1.330,00
ARIA SP D	BC/SF	NL	E27 2×77W E27	⊥ IP20	CE	EREC	DIM 1	1.200,00

ASSIBA

design Mauro Olivieri 2011

finitura vetro / glass finish finitura struttura / frame finish



BC/BT

CR/BT

MC/2

MC/3

CR

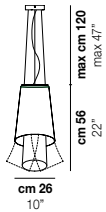

ASSIBA SP 2

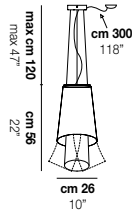

ASSIBA SP 2 D1

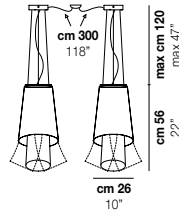

ASSIBA SP 2 D2

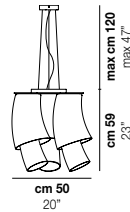

ASSIBA SP 6

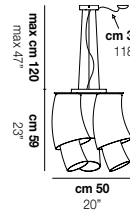

ASSIBA SP 6 D1

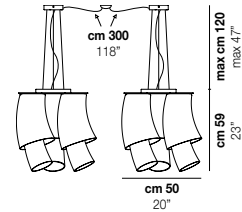

ASSIBA SP 6 D2

codice / code	vetro / glass	struttura / frame	elettrificazione / lampping	CL. IP	EU cert.	International cert.	dimmer	€
ASSIBASP2	MC/2 MC/3	CR	E27 1x77W E27	⊥ IP20	CE CB EAC		DIM 1	800,00
ASSIBASP2	MC/2 MC/3	CR	LED C 8,5W;5W 600 lm 2.700 K	⊥ IP20	CE CB EAC		DIM 3	900,00
ASSIBASP2	BC/BT	CR	E27 1x77W E27	⊥ IP20	CE CB EAC		DIM 1	830,00
ASSIBASP2	BC/BT	CR	LED C 5W 600 lm 2.700 K	⊥ IP20	CE CB EAC		DIM 3	930,00
ASSIBASP2	CR/BT	CR	E27 1x77W E27	⊥ IP20	CE CB EAC		DIM 1	850,00
ASSIBASP2	CR/BT	CR	LED C 5W 600 lm 2.700 K	⊥ IP20	CE CB EAC		DIM 3	950,00
ASSIBASP2D1	MC/2 MC/3	CR	E27 1x77W E27	⊥ IP20	CE CB EAC		DIM 1	840,00
ASSIBASP2D1	MC/2 MC/3	CR	LED C 8,5W;5W 600 lm 2.700 K	⊥ IP20	CE CB EAC		DIM 3	940,00
ASSIBASP2D1	BC/BC	CR	E27 1x77W E27	⊥ IP20	CE CB EAC		DIM 1	860,00
ASSIBASP2D1	BC/BC	CR	LED C 5W 600 lm 2.700 K	⊥ IP20	CE CB EAC		DIM 3	960,00
ASSIBASP2D1	CR/BT	CR	E27 1x77W E27	⊥ IP20	CE CB EAC		DIM 1	880,00
ASSIBASP2D1	CR/BT	CR	LED C 5W 600 lm 2.700 K	⊥ IP20	CE CB EAC		DIM 3	980,00
ASSIBASP2D2	MC/2 MC/3	CR	E27 2x77W E27	⊥ IP20	CE CB EAC		DIM 1	1.610,00
ASSIBASP2D2	BC/BC	CR	E27 2x77W E27	⊥ IP20	CE CB EAC		DIM 1	1.680,00
ASSIBASP2D2	CR/BT	CR	E27 2x77W E27	⊥ IP20	CE CB EAC		DIM 1	1.720,00
ASSIBASP6	MC/2 MC/3	CR	E27 3x77W E27	⊥ IP20	CE CB EAC		DIM 1	2.200,00
ASSIBASP6	MC/2 MC/3	CR	LED C 5W 3600 lm 2.700 K	⊥ IP20	CE CB EAC		DIM 3	2.500,00
ASSIBASP6	BC/BT	CR	E27 3x77W E27	⊥ IP20	CE CB EAC		DIM 1	2.080,00
ASSIBASP6	BC/BT	CR	LED C 5W 1800 lm 2.700 K	⊥ IP20	CE CB EAC		DIM 3	2.380,00
ASSIBASP6	CR/BT	CR	E27 3x77W E27	⊥ IP20	CE CB EAC		DIM 1	2.290,00
ASSIBASP6	CR/BT	CR	LED C 5W 1800 lm 2.700 K	⊥ IP20	CE CB EAC		DIM 3	2.590,00
ASSIBASP6D1	BC/BT	CR	E27 3x77W E27	⊥ IP20	CE CB EAC		DIM 1	2.080,00
ASSIBASP6D1	BC/BT	CR	LED C 5W 1800 lm 2.700 K	⊥ IP20	CE CB EAC		DIM 3	2.380,00
ASSIBASP6D1	CR/BT	CR	E27 3x77W E27	⊥ IP20	CE CB EAC		DIM 1	2.290,00
ASSIBASP6D1	CR/BT	CR	LED C 5W 1800 lm 2.700 K	⊥ IP20	CE CB EAC		DIM 3	2.590,00
ASSIBASP6D2	BC/BT	CR	E27 6x77W E27	⊥ IP20	CE CB EAC		DIM 1	4.200,00
ASSIBASP6D2	CR/BT	CR	E27 6x77W E27	⊥ IP20	CE CB EAC		DIM 1	4.610,00

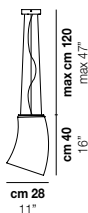

ASSIBA SP G

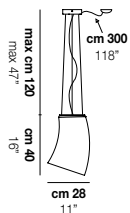

ASSIBA SP G D1

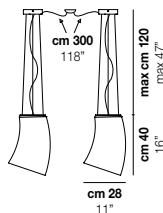

ASSIBA SP G D2

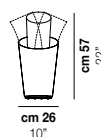

ASSIBA LT

codice / code	vetro / glass	struttura / frame	elettrificazione / lampping	CL. IP	EU cert.	International cert.	dimmer	€
ASSIBASPG	BC/BT CR/BT	CR	E27 1x77W E27	⊥ IP20	CE CB EAC		DIM 1	780,00
ASSIBASPG	BC/BT CR/BT	CR	LED C 5W 600 lm 2.700 K	⊥ IP20	CE CB EAC		DIM 3	880,00

codice / code	vetro / glass	struttura / frame	elettrificazione / lamping	CL. IP	EU cert.	International cert.	dimmer	€
ASSIBASPGD1	BC/BT CR/BT	CR	E27 1x77W E27	⊥ IP20	CE CB EAC	ERC	DIM 1	820,00
ASSIBASPGD1	BC/BT CR/BT	CR	LED C 5W 600 lm 2.700 K	⊥ IP20	CE CB EAC	ERC	DIM 3	920,00
ASSIBASPGD2	BC/BT CR/BT	CR	E27 2x77W E27	⊥ IP20	CE CB EAC	ERC	DIM 1	1.600,00
ASSIBALT	MC/2 MC/3	CR	E27 1x77W E27	⊥ IP20	CE CB EAC	ERC	DIM 4A	700,00
ASSIBALT	BC/BT	CR	E27 1x77W E27	⊥ IP20	CE CB EAC	ERC	DIM 4A	710,00
ASSIBALT	CR/BT	CR	E27 1x77W E27	⊥ IP20	CE CB EAC	ERC	DIM 4A	730,00

finitura vetro / glass finish | finitura struttura / frame finish

AURORA

studio tecnico Vetreria Vistosi 1986



BC/CR



BC

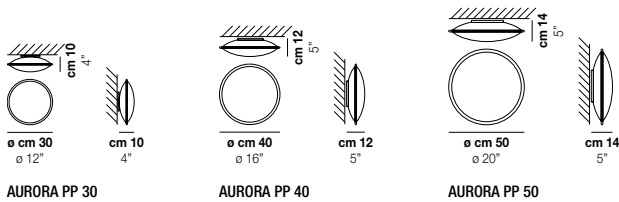

AURORA PP 30

AURORA PP 40

AURORA PP 50

codice / code	vetro / glass	struttura / frame	elettrificazione / lamping	CL. IP	EU cert.	International cert.	dimmer	€
AURORAPP30	BC/CR	BC	E27 1x77W E27	⊥ IP20	CE CB EAC	ERC	DIM 1	168,00
AURORAPP30	BC/CR	BC	LED F 12,5W 1650 lm 3.000 K	⊥ IP20	CE CB EAC	ERC	DIM 3	268,00
AURORAPP30	BC/CR	BC	LED I 10W 1120 lm 3.000 K	⊥ IP20	CE CB EAC	ERC	DIM 2	253,00
AURORAPP40	BC/CR	BC	E27 1x77W E27	⊥ IP20	CE CB EAC	ERC	DIM 1	240,00
AURORAPP40	BC/CR	BC	LED F 12,5W 1650 lm 3.000 K	⊥ IP20	CE CB EAC	ERC	DIM 3	340,00
AURORAPP40	BC/CR	BC	LED I 10W 1120 lm 3.000 K	⊥ IP20	CE CB EAC	ERC	DIM 2	325,00
AURORAPP50	BC/CR	BC	E27 2x77W E27	⊥ IP20	CE CB EAC	ERC	DIM 1	310,00
AURORAPP50	BC/CR	BC	LED G 19,5W 2850 lm 3.000 K	⊥ IP20	CE CB EAC	ERC	DIM 3	430,00
AURORAPP50	BC/CR	BC	LED J 10W 1120 lm 3.000 K	⊥ IP20	CE CB EAC	ERC	DIM 2	410,00

finitura vetro / glass finish | finitura struttura / frame finish

BACO

design Mauro Olivieri 1998



BC/SF



NI

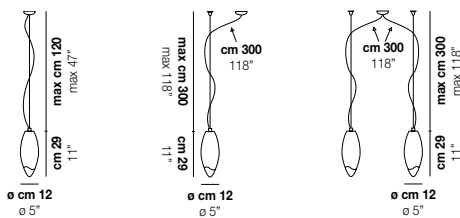

BACO SP P

BACO SP P D1

BACO SP P D2

codice / code	vetro / glass	struttura / frame	elettrificazione / lamping	CL. IP	EU cert.	International cert.	dimmer	€
BACOSP P	BC/SF	NI	E27 1x70W E27	☐ IP20	CE CB EAC	ERC	DIM 1	250,00
BACOSP P	BC/SF	NI	LED C 5W 600 lm 2.700 K	⊥ IP20	CE CB EAC	ERC	DIM 3	350,00
BACOSP P D1	BC/SF	NI	E27 1x70W E27	☐ IP20	CE CB EAC	ERC	DIM 1	275,00
BACOSP P D1	BC/SF	NI	LED C 5W 600 lm 2.700 K	⊥ IP20	CE CB EAC	ERC	DIM 3	375,00
BACOSP P D2	BC/SF	NI	E27 2x70W E27	☐ IP20	CE CB EAC	ERC	DIM 1	520,00
BACOSP G	BC/SF	NI	E27 1x77W E27	☐ IP20	CE CB EAC	ERC	DIM 1	325,00
BACOSP G	BC/SF	NI	LED C 5W 600 lm 2.700 K	⊥ IP20	CE CB EAC	ERC	DIM 3	425,00
BACOSP G	BC/SF	NI	E27 1x77W E27	☐ IP20	CE CB EAC	ERC	DIM 1	325,00

BACOSP G	BC/SF	NI	LED C	5W	600 lm	2.700 K	⊥ IP20	CE CB EAC	DIM 3	425,00
BACOSPGD1	BC/SF	NI	E27	1x77W E27			□ IP20	CE CB EAC	DIM 1	345,00
BACOSPGD1	BC/SF	NI	LED C	5W	600 lm	2.700 K	⊥ IP20	CE CB EAC	DIM 3	445,00

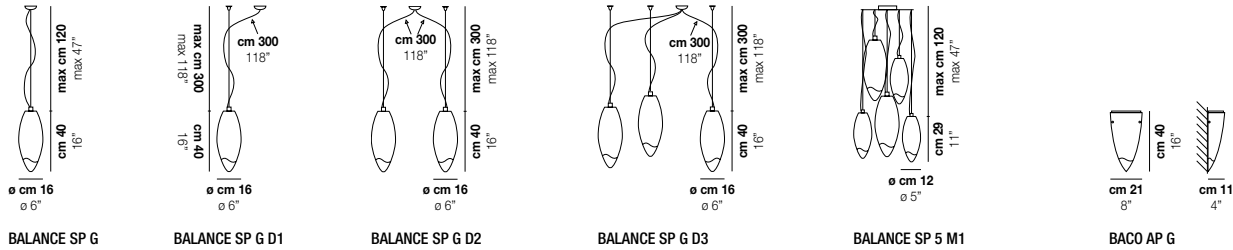

codice / code	vetro / glass	struttura / frame	elettrificazione / lamping	CL. IP	EU cert.	International cert.	dimmer	€
BACOSPGD2	BC/SF	NI	E27 2x77W E27	□ IP20	CE CB EAC		DIM 1	660,00
BACOSPGD3	BC/SF	NI	E27 3x77W E27	□ IP20	CE CB EAC		DIM 1	930,00
BACOSP5M1	BC/SF	NI	E27 5x70W E27	□ IP20	CE CB EAC		DIM 1	988,00
BACO AP G	BC/SF		R7s 1x80W R7s	⊥ IP20	CE	EAC		245,00

finitura vetro / glass finish | finitura struttura / frame finish

BALANCE

design Pio e Tito Toso 2011

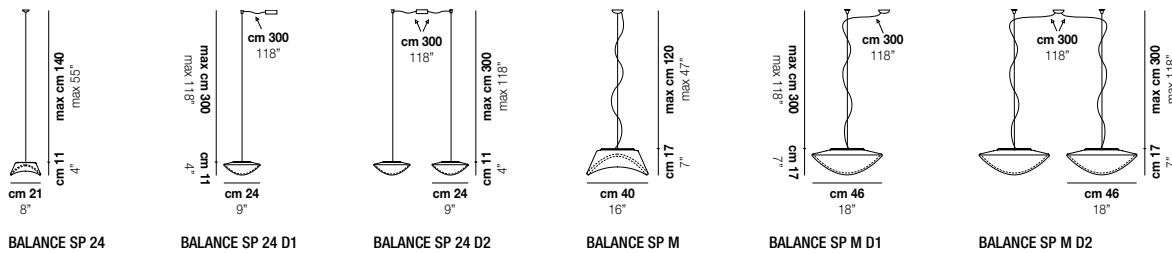

codice / code	vetro / glass	struttura / frame	elettrificazione / lamping	CL. IP	EU cert.	International cert.	dimmer	€
BALANCE SP 24	BC/LU	NIB	E14 1x46W E14	□ IP20	CE CB EAC		DIM 1	146,00
BALANCE SP 24	BC/LU	NIB	LED E 6W	⊥ IP20	CE CB EAC		DIM 3	271,00
BALANCE SP 24 D1	BC/LU	NIB	E14 1x46W E14	⊥ IP20	CE CB EAC		DIM 1	168,00
BALANCE SP 24 D1	BC/LU	NIB	LED E 6W	⊥ IP20	CE CB EAC		DIM 3	293,00
BALANCE SP 24 D2	BC/LU	NIB	E14 2x46W E14	⊥ IP20	CE CB EAC		DIM 1	315,00
BALANCE SP M	BC/LU	NIB	E27 2x77W E27	⊥ IP20	CE CB EAC		DIM 1	410,00
BALANCE SP M	BC/LU	NIB	LED G 19,5W	⊥ IP20	CE CB EAC		DIM 3	540,00
BALANCE SP M	BC/LU	NIB	LED J 10W	⊥ IP20	CE CB EAC		DIM 2	520,00
BALANCE SP M D1	BC/LU	NIB	E27 2x77W E27	⊥ IP20	CE CB EAC		DIM 1	440,00
BALANCE SP M D1	BC/LU	NIB	LED G 19,5W	⊥ IP20	CE CB EAC		DIM 3	570,00
BALANCE SP M D1	BC/LU	NIB	LED J 10W	⊥ IP20	CE CB EAC		DIM 2	550,00
BALANCE SP M D2	BC/LU	NIB	E27 4x77W E27	⊥ IP20	CE CB EAC		DIM 1	860,00

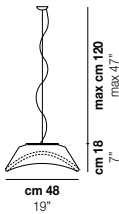

BALANCE SP G

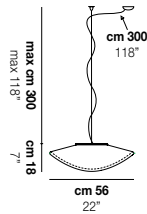

BALANCE SP G D1

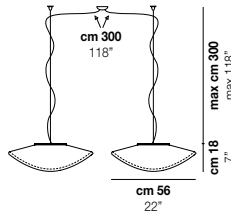

BALANCE SP G D2

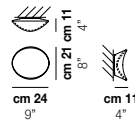

BALANCE PP 24

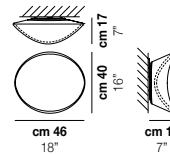

BALANCE PP M

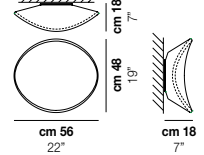

BALANCE PP G

codice / code	vetro / glass	struttura / frame	elettrificazione / lamping	CL. IP	EU cert.	International cert.	dimmer	€
BALANCE SP G	BC/LU	NIB	E27 2x77W E27	IP20	CE CB	ERC	DIM 1	510,00
BALANCE SP G	BC/LU	NIB	LED G 19,5W 2850 lm 3.000 K	IP20	CE CB	ERC	DIM 3	640,00
BALANCE SP G	BC/LU	NIB	LED J 10W 1120 lm 3.000 K	IP20	CE CB	ERC	DIM 2	620,00
BALANCE SP G D1	BC/LU	NIB	E27 2x77W E27	IP20	CE CB	ERC	DIM 1	550,00
BALANCE SP G D1	BC/LU	NIB	LED G 19,5W 2850 lm 3.000 K	IP20	CE CB	ERC	DIM 3	680,00
BALANCE SP G D1	BC/LU	NIB	LED J 10W 1120 lm 3.000 K	IP20	CE CB	ERC	DIM 2	660,00
BALANCE SP G D2	BC/LU	NIB	E27 4x77W E27	IP20	CE CB	ERC	DIM 1	1.070,00
BALANCE PP 24	BC/LU	BC	E14 1x48W E14	IP20	CE CB	ERC	DIM 1	116,00
BALANCE PP 24	BC/LU	BC	LED E 6W 825 lm 3.000 K	IP20	CE CB	ERC	DIM 3	231,00
BALANCE PP M	BC/LU	BC	E27 2x77W E27	IP20	CE CB	ERC	DIM 1	310,00
BALANCE PP M	BC/LU	BC	LED G 19,5W 2850 lm 3.000 K	IP20	CE CB	ERC	DIM 3	430,00
BALANCE PP M	BC/LU	BC	LED J 10W 1120 lm 3.000 K	IP20	CE CB	ERC	DIM 2	410,00
BALANCE PP G	BC/LU	BC	E27 2x77W E27	IP20	CE CB	ERC	DIM 1	400,00
BALANCE PP G	BC/LU	BC	LED G 19,5W 2850 lm 3.000 K	IP20	CE CB	ERC	DIM 3	520,00
BALANCE PP G	BC/LU	BC	LED J 10W 1120 lm 3.000 K	IP20	CE CB	ERC	DIM 2	500,00

finitura vetro / glass finish | finitura struttura / frame finish

BIANCA

studio tecnico Vetreria Vistosi 1996

BC

BC

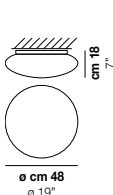

BIANCA PL 48

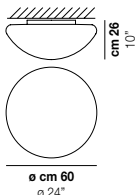

BIANCA PL 60

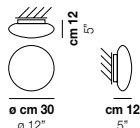

BIANCA PP 30

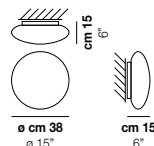

BIANCA PP 38

codice / code	vetro / glass	struttura / frame	elettrificazione / lamping	CL. IP	EU cert.	International cert.	dimmer	€
BIANCA PL 48	BC	BC	E27 3x77W E27	IP20	CE CB	ERC	DIM 1	132,00
BIANCA PL 48	BC	BC	LED W 10W 1120 lm 3.000 K	IP20	CE	ERC	DIM 2	228,00
BIANCA PL 48	BC	BC	LED X 19,5W 2850 lm 3.000 K	IP20	CE	ERC	DIM 3	243,00
BIANCA PL 60	BC	BC	E27 3x77W E27	IP20	CE CB	ERC	DIM 1	335,00
BIANCA PL 60	BC	BC	LED U 10W 1120 lm 3.000 K	IP20	CE	ERC	DIM 2	430,00
BIANCA PL 60	BC	BC	LED V 19,5W 2850 lm 3.000 K	IP20	CE	ERC	DIM 3	450,00
BIANCA PP 30	BC	BC	E27 1x77W E27	IP20	CE CB	ERC	DIM 1	68,00
BIANCA PP 30	BC	BC	LED 10W 1120 lm	IP20	CE	ERC	DIM 2	163,00
BIANCA PP 30	BC	BC	LED R 12,5W 1650 lm 3.000 K	IP20	CE	ERC	DIM 3	168,00
BIANCA PP 38	BC	BC	E27 1x77W E27	IP20	CE CB	ERC	DIM 1	108,00
BIANCA PP 38	BC	BC	LED S 10W 1120 lm 3.000 K	IP20	CE	ERC	DIM 2	203,00
BIANCA PP 38	BC	BC	LED T 12,5W 1650 lm 3.000 K	IP20	CE	ERC	DIM 3	208,00

BISSONA

archivio storico Vetreria Vistosi 1968 - restyling 2007

finitura vetro / glass finish | finitura struttura / frame finish



BC/LU



| BC

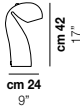

BISSONA LT

codice / code	vetro / glass	struttura / frame	elettrificazione / lamping	CL. IP	EU cert.	International cert.	dimmer	€
BISSONALT	BC/LU	BC	G9 1×60W G9	IP20			DIM 4A	410,00

BOLLE

design Barbara Maggiolo 2003

finitura vetro / glass finish | finitura struttura / frame finish



BC/BO



CR/BO



| BC

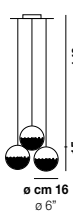
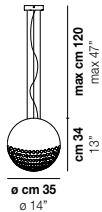
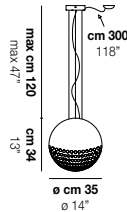
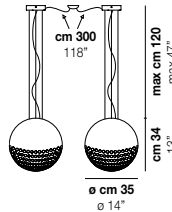
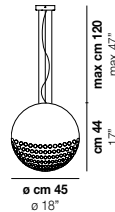
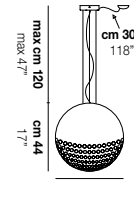

NI

**BOLLE SP 3 P****BOLLE SP 35****BOLLE SP 35 D1****BOLLE SP 35 D2****BOLLE SP 45****BOLLE SP 45 D1**

codice / code	vetro / glass	struttura / frame	elettrificazione / lamping	CL. IP	EU cert.	International cert.	dimmer	€
BOLLESP3P	BC/BO CR/BO	NI	G9 3×60W G9	IP20			DIM 1	630,00
BOLLESP35	BC/BO CR/BO	NI	E27 1×77W E27	IP20			DIM 1	325,00
BOLLESP35	BC/BO CR/BO	NI	LED C 5W 600 lm 2.700 K	IP20			DIM 3	425,00
BOLLESP35 D1	BC/BO CR/BO	NI	E27 1×77W E27	IP20			DIM 1	345,00
BOLLESP35 D1	BC/BO CR/BO	NI	LED C 5W 600 lm 2.700 K	IP20			DIM 3	445,00
BOLLESP35 D2	BC/BO CR/BO	NI	E27 2×77W E27	IP20			DIM 1	670,00
BOLLESP45	BC/BO CR/BO	NI	E27 3×77W E27	IP20			DIM 1	580,00
BOLLESP45 D1	BC/BO CR/BO	NI	E27 3×77W E27	IP20			DIM 1	610,00

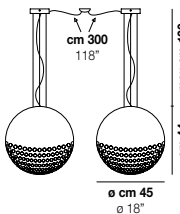
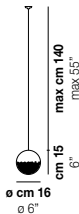
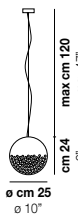
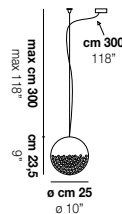
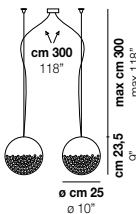
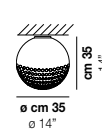
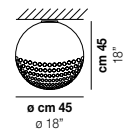
**BOLLE SP 45 D2****BOLLE SP P****BOLLE SP G****BOLLE SP G D1****BOLLE SP G D2****BOLLE PL 35****BOLLE PL 45**

codice / code	vetro / glass	struttura / frame	elettrificazione / lamping	CL. IP	EU cert.	International cert.	dimmer	€
BOLLESP45 D2	BC/BO CR/BO	NI	E27 6×77W E27	IP20			DIM 1	1.180,00
BOLLESP P	BC/BO CR/BO	NI	G9 1×60W G9	IP20			DIM 1	188,00

codice / code	vetro / glass	struttura / frame	elettrificazione / lamping	CL. IP	EU cert.	International cert.	dimmer	€
BOLLESPP	BC/BO CR/BO	NI	LED B 5W 600 lm 2.700 K	⊥ IP20	CE CB EAC		DIM 3	338,00
BOLLESPG	BC/BO CR/BO	NI	E27 1x77W E27	⊥ IP20	CE CB EAC	UL PS	DIM 1	305,00
BOLLESPG	BC/BO CR/BO	NI	LED C 5W 600 lm 2.700 K	⊥ IP20	CE CB EAC		DIM 3	405,00
BOLLESPGD1	BC/BO CR/BO	NI	E27 1x77W E27	⊥ IP20	CE CB EAC	UL	DIM 1	335,00
BOLLESPGD1	BC/BO CR/BO	NI	LED C 5W 600 lm 2.700 K	⊥ IP20	CE CB EAC		DIM 3	435,00
BOLLESPGD2	BC/BO CR/BO	NI	E27 2x77W E27	⊥ IP20	CE CB EAC	UL	DIM 1	640,00
BOLLEPL35	BC/BO	BC	E27 1x77W E27	⊥ IP20	CE CB EAC	UL	DIM 1	280,00
BOLLEPL35	BC/BO	BC	LED F 12,5W 1650 lm 3.000 K	⊥ IP20	CE CB EAC		DIM 3	385,00
BOLLEPL35	BC/BO	BC	LED I 10W 1120 lm 3.000 K	⊥ IP20	CE CB EAC		DIM 2	365,00
BOLLEPL45	BC/BO	BC	E27 3x77W E27	⊥ IP20	CE CB EAC	UL	DIM 1	510,00
BOLLEPL45	BC/BO	BC	LED F 12,5W 1650 lm 3.000 K	⊥ IP20	CE CB EAC		DIM 3	615,00
BOLLEPL45	BC/BO	BC	LED I 10W 1120 lm 3.000 K	⊥ IP20	CE CB EAC		DIM 2	595,00



BOLLE PL G

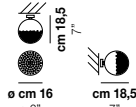

BOLLE FA P



BOLLE LT P

codice / code	vetro / glass	struttura / frame	elettrificazione / lamping	CL. IP	EU cert.	International cert.	dimmer	€
BOLLEPLG	BC/BO CR/BO	NI	E27 1x77W E27	⊥ IP20	CE CB EAC	UL	DIM 1	395,00
BOLLEPLG	BC/BO CR/BO	NI	LED C 5W 600 lm 2.700 K	⊥ IP20	CE CB EAC	UL	DIM 3	495,00
BOLLEFAP	BC/BO CR/BO	NI	G9 1x60W G9	□ IP20	CE CB EAC	UL PS	DIM 1	225,00
BOLLEFAP	BC/BO CR/BO	NI	LED D 5W 600 lm 2.700 K	⊥ IP20	CE CB EAC	UL	DIM 3	375,00
BOLLELTP	BC/BO CR/BO	NI	G9 1x60W G9	□ IP20	CE EAC	UL PS	DIM 4A	240,00

finitura vetro / glass finish | finitura struttura / frame finish



BC/CR | BC

BOT

design Gregorio Spini 2011

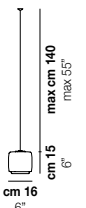

BOT SP 16

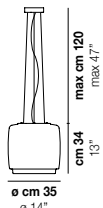

BOT SP 35

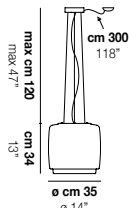

BOT SP 35 D1

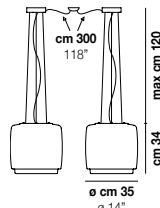

BOT SP 35 D2



BOT SP 45

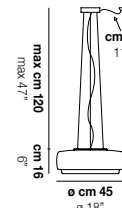

BOT SP 45 D1

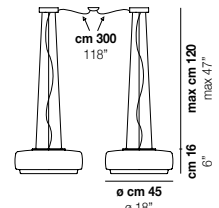

BOT SP 45 D2

codice / code	vetro / glass	struttura / frame	elettrificazione / lamping	CL. IP	EU cert.	International cert.	dimmer	€
BOTSP16	BC/CR	BC	G9 1x60W G9	□ IP20	CE CB EAC	UL	DIM 1	250,00
BOTSP16	BC/CR	BC	LED B 5W 600 lm 2.700 K	⊥ IP20	CE CB EAC	UL	DIM 3	400,00
BOTSP35	BC/CR	BC	E27 3x77W E27	⊥ IP20	CE CB EAC	UL	DIM 1	570,00
BOTSP35	BC/CR	BC	LED G 19,5W 2850 lm 3.000 K	⊥ IP20	CE CB EAC	UL	DIM 3	700,00
BOTSP35	BC/CR	BC	LED J 10W 1120 lm 3.000 K	⊥ IP20	CE CB EAC	UL	DIM 2	680,00
BOTSP35D1	BC/CR	BC	E27 3x77W E27	⊥ IP20	CE CB EAC	UL	DIM 1	590,00
BOTSP35D1	BC/CR	BC	LED G 19,5W 2850 lm 3.000 K	⊥ IP20	CE CB EAC	UL	DIM 3	720,00
BOTSP35D1	BC/CR	BC	LED J 10W 1120 lm 3.000 K	⊥ IP20	CE CB EAC	UL	DIM 2	700,00
BOTSP35D2	BC/CR	BC	E27 6x77W E27	⊥ IP20	CE CB EAC	UL	DIM 1	1.150,00
BOTSP45	BC/CR	BC	E27 2x77W E27	⊥ IP20	CE CB EAC	UL	DIM 1	600,00
BOTSP45	BC/CR	BC	LED G 19,5W 2850 lm 3.000 K	⊥ IP20	CE CB EAC	UL	DIM 3	730,00
BOTSP45	BC/CR	BC	LED J 10W 1120 lm 3.000 K	⊥ IP20	CE CB EAC	UL	DIM 2	710,00

codice / code	vetro / glass	struttura / frame	elettrificazione / lamping	CL. IP	EU cert.	International cert.	dimmer	€
BOTSP45 D1	BC/CR	BC	E27 2x77W E27	⊥ IP20	CE CB EAC	ERC	DIM 1	620,00
BOTSP45 D1	BC/CR	BC	LED G 19,5W 2850 lm 3.000 K	⊥ IP20	CE CB EAC	ERC	DIM 3	750,00
BOTSP45 D1	BC/CR	BC	LED J 10W 1120 lm 3.000 K	⊥ IP20	CE CB EAC	ERC	DIM 2	730,00
BOTSP45 D2	BC/CR	BC	E27 4x77W E27	⊥ IP20	CE CB EAC	ERC	DIM 1	1.210,00

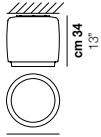

BOT PL 35

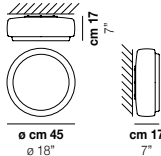

BOT PP 45

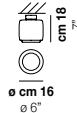

BOT FA 16



BOT LT 16

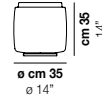

BOT LT 35

codice / code	vetro / glass	struttura / frame	elettrificazione / lamping	CL. IP	EU cert.	International cert.	dimmer	€
BOTPL35	BC/CR	BC	E27 3x77W E27	⊥ IP20	CE CB EAC	ERC	DIM 1	420,00
BOTPL35	BC/CR	BC	LED G 19,5W 2850 lm 3.000 K	⊥ IP20	CE CB EAC	ERC	DIM 3	540,00
BOTPL35	BC/CR	BC	LED J 10W 1120 lm 3.000 K	⊥ IP20	CE CB EAC	ERC	DIM 2	520,00
BOTPP45	BC/CR	BC	E27 2x77W E27	⊥ IP20	CE CB EAC	ERC	DIM 1	520,00
BOTPP45	BC/CR	BC	LED G 19,5W 2850 lm 3.000 K	⊥ IP20	CE CB EAC	ERC	DIM 3	640,00
BOTPP45	BC/CR	BC	LED J 10W 1120 lm 3.000 K	⊥ IP20	CE CB EAC	ERC	DIM 2	620,00
BOTFA16	BC/CR	BC	G9 1x60W G9	□ IP20	CE CB EAC	ERC	DIM 1	250,00
BOTFA16	BC/CR	BC	LED D 5W 600 lm 2.700 K	⊥ IP20	CE CB EAC	ERC	DIM 3	400,00
BOTLT16	BC/CR	BC	G9 1x60W G9	□ IP20	CE CB EAC	ERC	DIM 4A	275,00
BOTLT35	BC/CR	BC	E27 3x77W E27	⊥ IP20	CE CB EAC	ERC	DIM 4A	590,00

finitura vetro / glass finish | finitura struttura / frame finish

CANDELA

studio tecnico Vetreria Vistosi 2010

BC/LU

CR



CANDELA SP

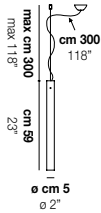

CANDELA SP D1

codice / code	vetro / glass	struttura / frame	elettrificazione / lamping	CL. IP	EU cert.	International cert.	dimmer	€
CANDELASP	BCLU	CR	G9 1x60W G9	⊥ IP20	CE CB EAC	ERC	DIM 1	198,00
CANDELASPD1	BCLU	CR	G9 1x60W G9	⊥ IP20	CE CB EAC	ERC	DIM 1	215,00

finitura vetro / glass finish | finitura struttura / frame finish

CLEO

design Barbara Maggiolo 2009



BC/LU | NI

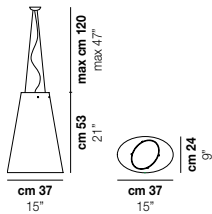

CLEO SP G

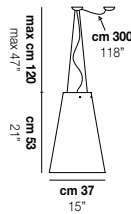

CLEO SP G D1

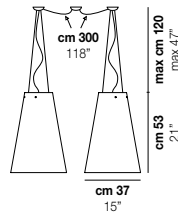

CLEO SP G D2

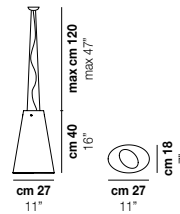

CLEO SP

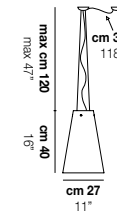

CLEO SP D1

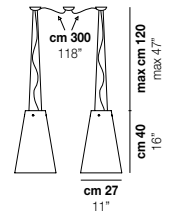

CLEO SP D2

codice / code	vetro / glass	struttura / frame	elettrificazione / lamping	CL. IP	EU cert.	International cert.	dimmer	€
CLEOSP G	BC/LU	NI	E27 1x77W E27	⊥ IP20	CE CB	ERC	DIM 1	590,00
CLEOSP G	BC/LU	NI	LED C 5W 600 lm 2.700 K	⊥ IP20	CE CB	ERC	DIM 3	690,00
CLEOSP GD1	BC/LU	NI	E27 1x77W E27	⊥ IP20	CE CB	ERC	DIM 1	620,00
CLEOSP GD1	BC/LU	NI	LED C 5W 600 lm 2.700 K	⊥ IP20	CE CB	ERC	DIM 3	720,00
CLEOSP GD2	BC/LU	NI	E27 2x77W E27	⊥ IP20	CE CB	ERC	DIM 1	1.030,00
CLEOSP	BC/LU	NI	E27 1x77W E27	⊥ IP20	CE CB	ERC	DIM 1	295,00
CLEOSP	BC/LU	NI	LED C 5W 600 lm 2.700 K	⊥ IP20	CE CB	ERC	DIM 3	395,00
CLEOSP D1	BC/LU	NI	E27 1x77W E27	⊥ IP20	CE CB	ERC	DIM 1	315,00
CLEOSP D1	BC/LU	NI	LED C 5W 600 lm 2.700 K	⊥ IP20	CE CB	ERC	DIM 3	415,00
CLEOSP D2	BC/LU	NI	E27 2x77W E27	⊥ IP20	CE CB	ERC	DIM 1	640,00

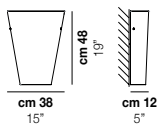

CLEO AP G

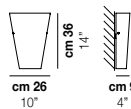

CLEO AP

codice / code	vetro / glass	struttura / frame	elettrificazione / lamping	CL. IP	EU cert.	International cert.	dimmer	€
CLEO AP G	BC/LU	NI	E27 2x77W E27	⊥ IP20	CE CB	ERC	DIM 1	260,00
CLEO AP	BC/LU	NI	E27 1x77W E27	⊥ IP20	CE CB	ERC	DIM 1	110,00

finitura vetro / glass finish | finitura struttura / frame finish

CLOTH

design Romani Saccani Architetti Associati 2009

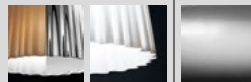

BC/CM | BC/ST | CR

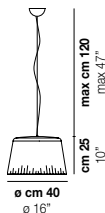

CLOTH SP G

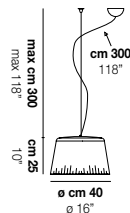

CLOTH SP G D1

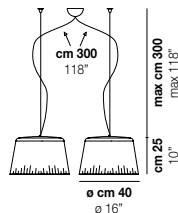

CLOTH SP G D2

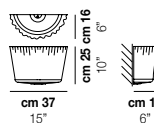

CLOTH AP G



CLOTH LT G

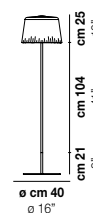

CLOTH PT G

codice / code	vetro / glass	struttura / frame	elettrificazione / lamping	CL. IP	EU cert.	International cert.	dimmer	€
CLOTHSPG	BC/CM	CR	E27 1x77W E27	⊥ IP20	CE CB	ERC	DIM 1	385,00
CLOTHSPG	BC/CM	CR	LED C 5W 600 lm 2.700 K	⊥ IP20	CE CB	ERC	DIM 3	485,00

codice / code	vetro / glass	struttura / frame	elettrificazione / lamping	CL. IP	EU cert.	International cert.	dimmer	€
CLOTHSP G	BC/ST	CR	E27 1x77W E27	⊥ IP20	CE CB EAC	PS	DIM 1	285,00
CLOTHSP G	BC/ST	CR	LED C 5W 600 lm 2.700 K	⊥ IP20	CE CB EAC	PS	DIM 3	385,00
CLOTHSP GD1	BC/CM	CR	E27 1x77W E27	⊥ IP20	CE CB EAC		DIM 1	420,00
CLOTHSP GD1	BC/CM	CR	LED C 5W 600 lm 2.700 K	⊥ IP20	CE CB EAC		DIM 3	520,00
CLOTHSP GD1	BC/ST	CR	E27 1x77W E27	⊥ IP20	CE CB EAC		DIM 1	315,00
CLOTHSP GD1	BC/ST	CR	LED C 5W 600 lm 2.700 K	⊥ IP20	CE CB EAC		DIM 3	415,00
CLOTHSP GD2	BC/CM	CR	E27 2x77W E27	⊥ IP20	CE CB EAC		DIM 1	820,00
CLOTHSP GD2	BC/ST	CR	E27 2x77W E27	⊥ IP20	CE CB EAC		DIM 1	610,00
CLOTHAP G	BC/CM	CR	E27 1x77W E27	⊥ IP20	CE CB EAC		DIM 1	345,00
CLOTHAP G	BC/ST	CR	E27 1x77W E27	⊥ IP20	CE CB EAC		DIM 1	280,00
CLOTHLT G	BC/CM	CR	E27 3x77W E27	⊥ IP20	CE EAC	PS	DIM 4A	700,00
CLOTHLT G	BC/ST	CR	E27 3x77W E27	⊥ IP20	CE EAC	PS	DIM 4A	600,00
CLOTHPT G	BC/CM	CR	E27 3x77W E27	⊥ IP20	CE EAC	PS		870,00
CLOTHPT G	BC/ST	CR	E27 3x77W E27	⊥ IP20	CE EAC	PS		760,00

finitura vetro / glass finish

CORNER

studio tecnico Vetreria Vistosi 1993

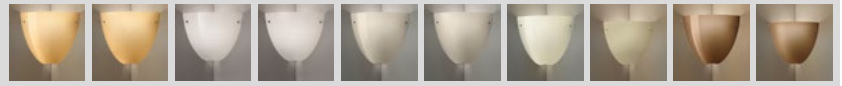

AM/LU AM/ST BC/LU BC/ST FU/LU FU/ST SB/LU SB/ST TB/LU TB/ST

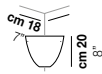

CORNER AP

codice / code	vetro / glass	struttura / frame	elettrificazione / lamping	CL. IP	EU cert.	International cert.	dimmer	€
CORNERAP	BC/LU AMLU BC/ST AM/ST		E27 1x77W E27	⊥ IP20	CE CB EAC		DIM 1	130,00
CORNERAP	FU/LU SB/LU TB/LU FU/ST SB/ST TB/ST		E27 1x77W E27	⊥ IP20	CE CB EAC		DIM 1	130,00

finitura vetro / glass finish | finitura struttura / frame finish

CRISTALLINA

design Romani Sacconi Architetti Associati 2017



BC/SF CR/MF NE/SF BO NEO

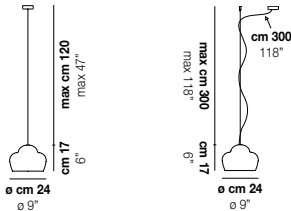

CRISTALLINA SP

CRISTALLINA SP D1

codice / code	vetro / glass	struttura / frame	elettrificazione / lamping	CL. IP	EU cert.	International cert.	dimmer	€
CRISTALLINA SP	CR/MF NE/SF	NEO	LED 12,5W 1650 lm	⊥ IP20	CE EAC		DIM 3	380,00
CRISTALLINA SP	BC/SF	BO	LED 12,5W 1650 lm	⊥ IP20	CE EAC		DIM 3	340,00
CRISTALLINA SP D1	CR/MF NE/SF	NEO	LED 12,5W 1650 lm	⊥ IP20	CE EAC		DIM 3	400,00
CRISTALLINA SP D1	BC/SF	BO	LED 12,5W 1650 lm	⊥ IP20	CE EAC		DIM 3	355,00

finitura vetro / glass finish

DAFNE

studio tecnico Vetreteria Vistosi 1993



AM/LU AM/ST BC/LU BC/ST FU/LU FU/ST SB/LU SB/ST TB/LU TB/ST

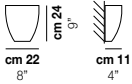

DAFNE AP

codice / code	vetro / glass	struttura / frame	elettrificazione / lamping	CL. IP	EU cert.	International cert.	dimmer	€
DAFNE AP	BC/LU AM/LU BC/ST AM/ST		E27 1x77W E27	⊥ IP20	CE CB	ERAC CCC	DIM 1	110,00
DAFNE AP	FU/LU SB/LU TB/LU FU/ST SB/ST TB/ST		E27 1x77W E27	⊥ IP20	CE CB	ERAC CCC	DIM 1	110,00

finitura vetro / glass finish | finitura struttura / frame finish

DAMASCO

design Paolo Crepax 2003



CR/AM CR/CR NI

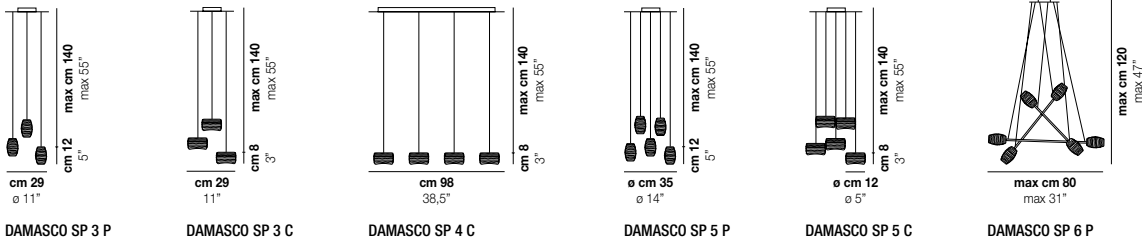

DAMASCO SP 3 P

DAMASCO SP 3 C

DAMASCO SP 4 C

DAMASCO SP 5 P

DAMASCO SP 5 C

DAMASCO SP 6 P

codice / code	vetro / glass	struttura / frame	elettrificazione / lamping	CL. IP	EU cert.	International cert.	dimmer	€
DAMASCO SP 3 P	CR/AM CR/CR	NI	G9 3x60W G9	⊥ IP20	CE CB	ERAC CCC PS	DIM 1	550,00
DAMASCO SP 3 C	CR/AM CR/CR	NI	G9 3x60W G9	⊥ IP20	CE CB	ERAC CCC PS	DIM 1	560,00
DAMASCO SP 4 C	CR/AM CR/CR	NI	G9 4x60W G9	⊥ IP20	CE CB	ERAC CCC PS	DIM 1	810,00
DAMASCO SP 5 P	CR/AM CR/CR	NI	G9 5x60W G9	⊥ IP20	CE CB	ERAC CCC PS	DIM 1	910,00
DAMASCO SP 5 C	CR/AM CR/CR	NI	G9 5x60W G9	⊥ IP20	CE CB	ERAC CCC	DIM 1	940,00
DAMASCO SP 6 P	CR/AM CR/CR	NI	G9 6x60W G9	⊥ IP20	CE	ERAC CCC	DIM 1	950,00

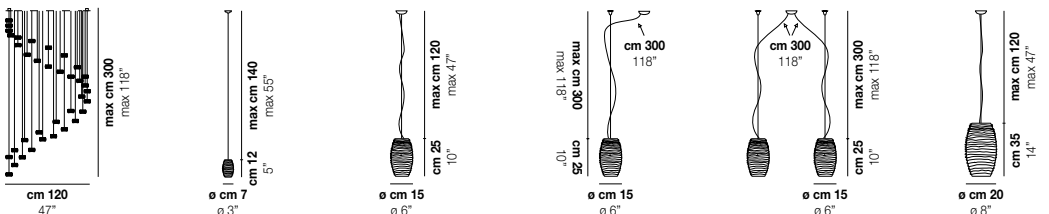

DAMASCO SP 36 C

DAMASCO SP P

DAMASCO SP M

DAMASCO SP M D1

DAMASCO SP M D2

DAMASCO SP G

codice / code	vetro / glass	struttura / frame	elettrificazione / lamping	CL. IP	EU cert.	International cert.	dimmer	€
DAMASCO SP 36 C	CR/AM CR/CR	NI	G9 36x60W G9	⊥ IP20	CE CB	ERAC CCC	DIM 1	7.700,00
DAMASCO SP P	CR/AM CR/CR	NI	G9 1x60W G9	⊥ IP20	CE CB	ERAC CCC PS	DIM 1	150,00
DAMASCO SP P	CR/AM CR/CR	NI	LED A 5W 600 lm 2.700 K	⊥ IP20	CE CB	ERAC CCC	DIM 3	300,00
DAMASCO SP M	CR/AM CR/CR	NI	E27 1x77W E27	⊥ IP20	CE CB	ERAC CCC	DIM 1	335,00
DAMASCO SP M	CR/AM CR/CR	NI	LED C 5W 600 lm 2.700 K	⊥ IP20	CE CB	ERAC CCC	DIM 3	435,00
DAMASCO SP M D1	CR/AM CR/CR	NI	E27 1x77W E27	⊥ IP20	CE CB	ERAC CCC	DIM 1	365,00
DAMASCO SP M D1	CR/AM CR/CR	NI	LED C 5W 600 lm 2.700 K	⊥ IP20	CE CB	ERAC CCC	DIM 3	475,00
DAMASCO SP M D2	CR/AM CR/CR	NI	E27 2x77W E27	⊥ IP20	CE CB	ERAC CCC	DIM 1	700,00

codice / code	vetro / glass	struttura / frame	elettrificazione / lamping	CL. IP	EU cert.	International cert.	dimmer	€
DAMASCO SP G	CR/AM CR/CR	NI	E27 1x77W E27	⊥ IP20	CE	CB certificata EAC cULus CCC PSE	DIM 1	530,00
DAMASCO SP G	CR/AM	NI	LED C 5W 600 lm 2.700 K	⊥ IP20	CE	CB certificata EAC cULus CCC PSE	DIM 3	640,00
DAMASCO SP G	CR/CR	NI	LED C 5W 600 lm 2.700 K	⊥ IP20	CE	CB certificata EAC cULus CCC PSE	DIM 3	630,00

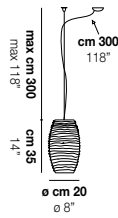

DAMASCO SP G D1

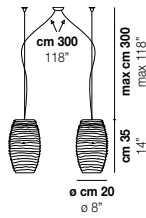

DAMASCO SP G D2

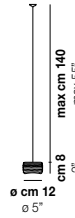

DAMASCO SP C

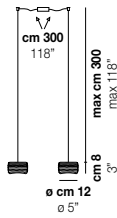

DAMASCO SP C D2

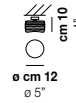

DAMASCO FA C

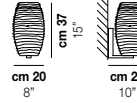

DAMASCO AP G

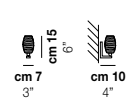

DAMASCO AP 1A P

codice / code	vetro / glass	struttura / frame	elettrificazione / lamping	CL. IP	EU cert.	International cert.	dimmer	€
DAMASCO SP GD1	CR/AM CR/CR	NI	E27 1x77W E27	⊥ IP20	CE	CB certificata EAC cULus CCC PSE	DIM 1	560,00
DAMASCO SP GD1	CR/AM CR/CR	NI	LED C 5W 600 lm 2.700 K	⊥ IP20	CE	CB certificata EAC cULus CCC PSE	DIM 3	670,00
DAMASCO SP GD2	CR/AM CR/CR	NI	E27 2x77W E27	⊥ IP20	CE	CB certificata EAC cULus CCC PSE	DIM 1	1.080,00
DAMASCO SP C	CR/AM CR/CR	NI	G9 1x60W G9	□ IP20	CE	CB certificata EAC cULus CCC PSE	DIM 1	170,00
DAMASCO SP C	CR/AM CR/CR	NI	LED B 5W 600 lm 2.700 K	⊥ IP20	CE	CB certificata EAC cULus CCC PSE	DIM 3	320,00
DAMASCO SP CD2	CR/AM CR/CR	NI	G9 2x60W G9	□ IP20	CE	CB certificata EAC cULus CCC PSE	DIM 1	440,00
DAMASCO FAC	CR/AM CR/CR	NI	G9 1x60W G9	⊥ IP20	CE	CB certificata EAC cULus CCC PSE	DIM 1	182,00
DAMASCO FAC	CR/AM CR/CR	NI	LED D 5W 600 lm 2.700 K	⊥ IP20	CE	CB certificata EAC cULus CCC PSE	DIM 3	332,00
DAMASCO AP G	CR/AM CR/CR	NI	E27 1x77W E27	⊥ IP20	CE	EAC cULus CCC PSE	DIM 1	590,00
DAMASCO AP 1A P	CR/AM CR/CR	NI	G9 1x60W G9	⊥ IP20	CE	EAC cULus CCC PSE	DIM 1	250,00

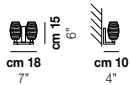

DAMASCO AP 2A P



DAMASCO LT P



DAMASCO LT M

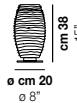

DAMASCO LT G

codice / code	vetro / glass	struttura / frame	elettrificazione / lamping	CL. IP	EU cert.	International cert.	dimmer	€
DAMASCO AP 2A P	CR/AM CR/CR	NI	G9 2x60W G9	⊥ IP20	CE	EAC cULus CCC PSE	DIM 1	365,00
DAMASCOLTP	CR/AM CR/CR	NI	G9 1x60W G9	□ IP20	CE	EAC cULus CCC PSE	DIM 4A	205,00
DAMASCOLTM	CR/AM CR/CR	NI	E27 1x77W E27	⊥ IP20	CE	CB certificata EAC cULus CCC PSE	DIM 4A	410,00
DAMASCOLTG	CR/AM CR/CR	NI	E27 1x77W E27	⊥ IP20	CE	CB certificata EAC cULus CCC PSE	DIM 4A	540,00

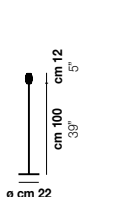

DAMASCO PT 100 P

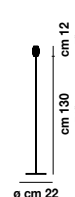

DAMASCO PT 140 P

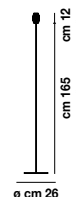

DAMASCO PT 180 P

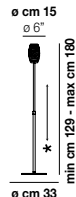

DAMASCO PT M



DAMASCO PT G

codice / code	vetro / glass	struttura / frame	elettrificazione / lamping	CL. IP	EU cert.	International cert.	dimmer	€
DAMASCOPT100P	CR/AM CR/CR	NI	G9 1x60W G9	□ IP20	CE	EAC cULus CCC PSE		305,00
DAMASCOPT140P	CR/AM CR/CR	NI	G9 1x60W G9	□ IP20	CE	EAC cULus CCC PSE		335,00
DAMASCOPT180P	CR/AM CR/CR	NI	G9 1x60W G9	□ IP20	CE	EAC cULus CCC PSE		385,00
DAMASCOPTM	CR/AM CR/CR	NI	E27 1x77W E27	□ IP20	CE	CB certificata EAC cULus CCC PSE		720,00
DAMASCOPTG	CR/AM CR/CR	NI	E27 1x77W E27	□ IP20	CE	CB certificata EAC cULus CCC PSE		900,00

finitura vetro / glass finish | finitura struttura / frame finish

DIADEMA

design Romani Sacconi Architetti Associati 2005

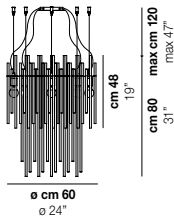
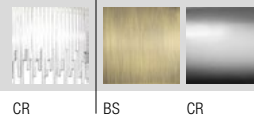

DIADEMA SP 60 B

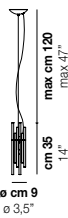

DIADEMA SP A P

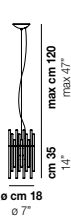

DIADEMA SP A M

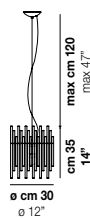

DIADEMA SP A G

codice / code	vetro / glass	struttura / frame	elettrificazione / lamping	CL. IP	EU cert.	International cert.	dimmer	€
DIADEMASP 60 B	CR	BS CR	E27 8x77W E27	⊥ IP20	CE CB	ERAC	DIM 1	2.400,00
DIADEMASP A P	BS CR	CR	G9 1x60W G9	⊥ IP20	CE	ERAC	DIM 1	235,00
DIADEMASP A P	BS CR	CR	LED C 5W 600 lm 2.700 K	⊥ IP20	CE CB	ERAC	DIM 3	345,00
DIADEMASP A M	BS CR	CR	E27 1x77W E27	⊥ IP20	CE CB	ERAC	DIM 1	370,00
DIADEMASP A M	BS CR	CR	LED C 5W 600 lm 2.700 K	⊥ IP20	CE CB	ERAC	DIM 3	480,00
DIADEMASP A G	BS CR	CR	E27 1x77W E27	⊥ IP20	CE CB	ERAC	DIM 1	520,00
DIADEMASP A G	BS CR	CR	LED C 5W 600 lm 2.700 K	⊥ IP20	CE CB	ERAC	DIM 3	630,00

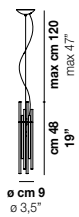

DIADEMA SP B P

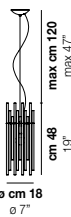

DIADEMA SP B M

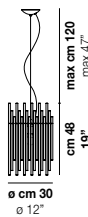

DIADEMA SP B G

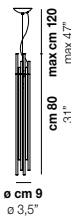

DIADEMA SP C P

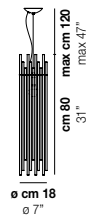

DIADEMA SP C M

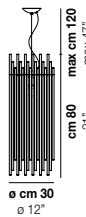

DIADEMA SP C G

codice / code	vetro / glass	struttura / frame	elettrificazione / lamping	CL. IP	EU cert.	International cert.	dimmer	€
DIADEMASP B P	BS CR	CR	G9 1x60W G9	⊥ IP20	CE	ERAC	DIM 1	275,00
DIADEMASP B P	BS CR	CR	LED C 5W 600 lm 2.700 K	⊥ IP20	CE CB	ERAC	DIM 3	385,00
DIADEMASP B M	BS CR	CR	E27 1x77W E27	⊥ IP20	CE CB	ERAC	DIM 1	465,00
DIADEMASP B M	BS CR	CR	LED C 5W 600 lm 2.700 K	⊥ IP20	CE CB	ERAC	DIM 3	575,00
DIADEMASP B G	BS CR	CR	E27 1x77W E27	⊥ IP20	CE CB	ERAC	DIM 1	675,00
DIADEMASP B G	BS CR	CR	LED C 5W 600 lm 2.700 K	⊥ IP20	CE CB	ERAC	DIM 3	785,00
DIADEMASP C P	BS CR	CR	G9 1x60W G9	⊥ IP20	CE	ERAC	DIM 1	325,00
DIADEMASP C P	BS CR	CR	LED C 5W 600 lm 2.700 K	⊥ IP20	CE CB	ERAC	DIM 3	435,00

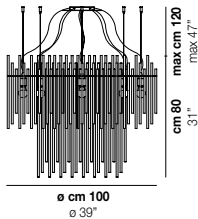

DIADEMA SP C-2

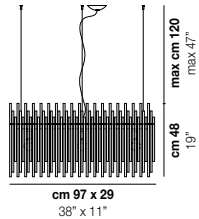

DIADEMA SP K3

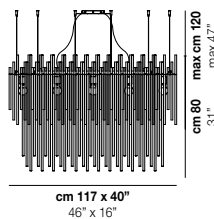

DIADEMA SP O2

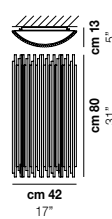

DIADEMA PL 80

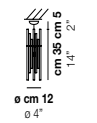

DIADEMA FA P

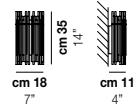

DIADEMA AP P G9

codice / code	vetro / glass	struttura / frame	elettrificazione / lamping	CL. IP	EU cert.	International cert.	dimmer	€
DIADEMA SP C-2	BS CR	CR	E27 8x77W E27	⊥ IP20	CE	CB ERL	DIM 1	3.730,00
DIADEMA SP K3	CR	CR	E27 3x77W E27	⊥ IP20	CE	CB ERL	DIM 1	2.090,00
DIADEMA SP O2	BS CR	CR	E27 10x77W E27	⊥ IP20	CE	CB ERL	DIM 1	2.900,00
DIADEMA PL 80	CR	CR	R7s 2x120W R7s	⊥ IP20	CE	ERL	DIM 1	920,00
DIADEMA FAP	CR	BS CR	G9 1x60W G9	⊥ IP20	CE	ERL	DIM 1	275,00
DIADEMA APP G9	CR	BS CR	G9 2x60W G9	⊥ IP20	CE	ERL	DIM 1	325,00
DIADEMA APL	CR	CR	R7s 2x80W R7s	⊥ IP20	CE	ERL	DIM 1	540,00
DIADEMA APGE27	CR	BS CR	E27 2x77W E27	⊥ IP20	CE	ERL	DIM 1	478,00

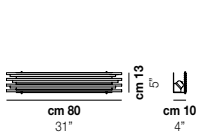

DIADEMA AP L

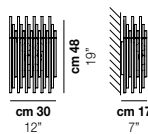

DIADEMA AP G E27

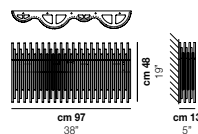

DIADEMA AP L

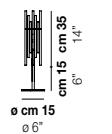

DIADEMA LT A P

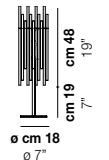

DIADEMA LT B P

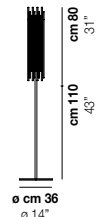

DIADEMA PT B G

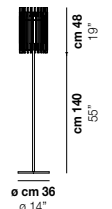

DIADEMA PT C M

codice / code	vetro / glass	struttura / frame	elettrificazione / lamping	CL. IP	EU cert.	International cert.	dimmer	€
DIADEMA APK3	CR	BS CR	G9 4x60W G9	⊥ IP20	CE	ERL	DIM 1	1.045,00
DIADEMA LT A P	BS CR	CR	G9 1x60W G9	⊥ IP20	CE	ERL	DIM 4A	345,00
DIADEMA LT B G	BS CR	CR	G9 1x60W G9	IP20	CE	ERL	DIM 4A	505,00
DIADEMA PT B G	BS CR	CR	G9 3x60W G9	⊥ IP20	CE	ERL		1.190,00
DIADEMA PT C M	BS CR	CR	G9 3x60W G9	⊥ IP20	CE	ERL		1.110,00

finitura vetro / glass finish finitura struttura / frame finish

DIAMANTE

design Barbara Maggiolo 2003

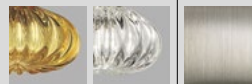

AM CR NI

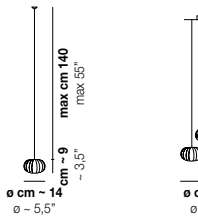

DIAMANTE SP 1

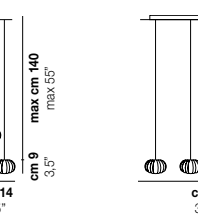

DIAMANTE SP 3

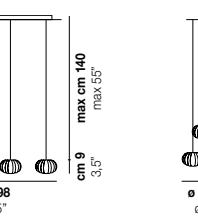

DIAMANTE SP 4

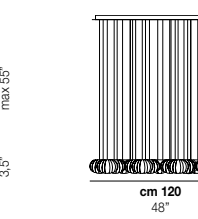

DIAMANTE SP 5

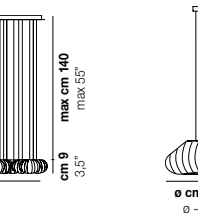

DIAMANTE SP 36

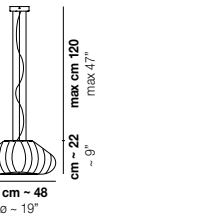

DIAMANTE SP 50

codice / code	vetro / glass	struttura / frame	elettrificazione / lamping	CL. IP	EU cert.	International cert.	dimmer	€
DIAMANTE SP 1	CR AM	NI	G9 1x60W G9	⊥ IP20	CE	CB ERL	DIM 1	182,00
DIAMANTE SP 1	CR AM	NI	LED B 5W 600 lm 2.700 K	⊥ IP20	CE	CB ERL	DIM 3	332,00
DIAMANTE SP 3	CR AM	NI	G9 3x60W G9	⊥ IP20	CE	CB ERL	DIM 1	580,00
DIAMANTE SP 4	CR AM	NI	G9 4x60W G9	⊥ IP20	CE	CB ERL	DIM 1	840,00

codice / code	vetro / glass	struttura / frame	elettrificazione / lamping	CL. IP	EU cert.	International cert.	dimmer	€
DIAMANTE SP5	CR AM	NI	G9 5×60W G9	⚡ IP20	CE CB	ERAC	DIM 1	980,00
DIAMANTE SP36	CR AM	NI	G9 36×60W G9	⚡ IP20	CE	ERAC	DIM 1	7.875,00
DIAMANTE SP50	CR	NI	E27 1×77W E27	⚡ IP20	CE CB	ERAC	DIM 1	680,00

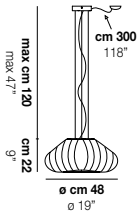

DIAMANTE SP 50 D1

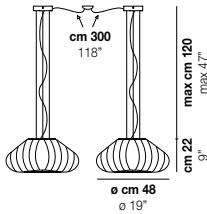

DIAMANTE SP 50 D2

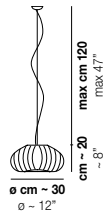

DIAMANTE SP G

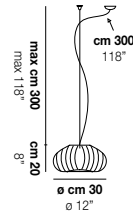

DIAMANTE SP G D1

codice / code	vetro / glass	struttura / frame	elettrificazione / lamping	CL. IP	EU cert.	International cert.	dimmer	€
DIAMANTE SP50 D1	CR	NI	E27 1×77W E27	⚡ IP20	CE CB	ERAC	DIM 1	710,00
DIAMANTE SP50 D2	CR	NI	E27 1×77W E27	⚡ IP20	CE CB	ERAC	DIM 1	1.390,00
DIAMANTE SPG	CR AM	NI	E27 1×77W E27	⚡ IP20	CE CB	ERAC	DIM 1	480,00
DIAMANTE SPG D1	CR AM	NI	E27 1×77W E27	⚡ IP20	CE CB	ERAC	DIM 1	510,00

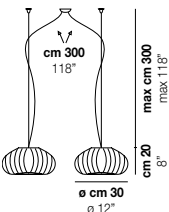

DIAMANTE SP G D2

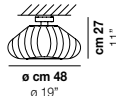

DIAMANTE PL 50

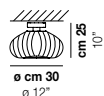

DIAMANTE PL G

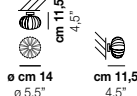

DIAMANTE FA

codice / code	vetro / glass	struttura / frame	elettrificazione / lamping	CL. IP	EU cert.	International cert.	dimmer	€
DIAMANTE SPG D2	CR AM	NI	E27 2×77W E27	⚡ IP20	CE CB	ERAC	DIM 1	990,00
DIAMANTE PL50	CR	NI	E27 1×77W E27	⚡ IP20	CE CB	ERAC	DIM 1	680,00
DIAMANTE PLG	CR AM	NI	E27 1×77W E27	⚡ IP20	CE CB	ERAC	DIM 1	485,00
DIAMANTE PLG	CR AM	NI	LED C 5W 600 lm 2.700 K	⚡ IP20	CE CB	ERAC	DIM 3	585,00
DIAMANTE FA	CR AM	NI	G9 1×60W G9	⚡ IP20	CE CB	ERAC	DIM 1	210,00
DIAMANTE FA	CR AM	NI	LED D 5W 600 lm 2.700 K	⚡ IP20	CE CB	ERAC	DIM 3	360,00

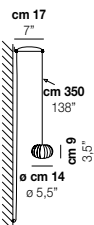

DIAMANTE AP KIT

codice / code	vetro / glass	struttura / frame	elettrificazione / lamping	CL. IP	EU cert.	International cert.	dimmer	€
DIAMANTE AP KIT	CR AM	NI	G9 1×60W G9	⚡ IP20	CE	ERAC	DIM 1	235,00

DRESS

studio tecnico Vetreria Vistosi 2005

finitura vetro / glass finish | finitura struttura / frame finish



BC/LU

CR

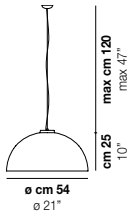

DRESS SP G

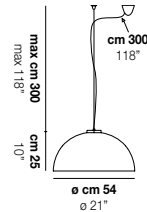

DRESS SP G D1

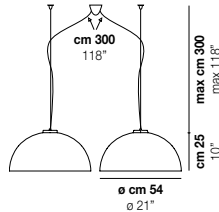

DRESS SP G D2

codice / code	vetro / glass	struttura / frame	elettrificazione / lamping	CL. IP	EU cert.	International cert.	dimmer	€
DRESS SP G	BCLU	CR	E27 1x77W E27	⊥ IP20	CE	CB EAC	DIM 1	450,00
DRESS SP G D1	BCLU	CR	E27 1x77W E27	⊥ IP20	CE	CB EAC	DIM 1	480,00
DRESS SP G D2	BCLU	CR	E27 2x77W E27	⊥ IP20	CE	CB EAC	DIM 1	940,00

ECOS

design Renato Toso, Noti Massari & Associati 2007

finitura vetro / glass finish | finitura struttura / frame finish



BC/RI

CR/RI

BS

CR

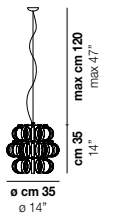

ECOS SP 35

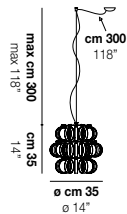

ECOS SP 35 D1

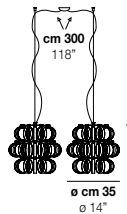

ECOS SP 35 D2



ECOS SP 90

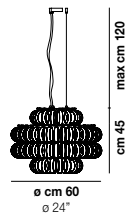

ECOS SP 60C

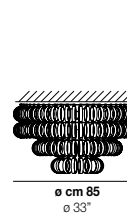

ECOS PL 90

codice / code	vetro / glass	struttura / frame	elettrificazione / lamping	CL. IP	EU cert.	International cert.	dimmer	€
ECOS SP 35	BC/RI CR/RI	BS CR	E27 1x77W E27	⊥ IP20	CE	EAC	DIM 1	710,00
ECOS SP 35 D1	BC/RI CR/RI	BS CR	E27 1x77W E27	⊥ IP20	CE	CB EAC	DIM 1	730,00
ECOS SP 35 D2	BC/RI CR/RI	BS CR	E27 2x77W E27	⊥ IP20	CE	CB EAC	DIM 1	1.440,00
ECOS SP 90	BC/RI CR/RI	BS CR	E27 5x77W E27	⊥ IP20	CE	CB EAC	DIM 1	5.550,00
ECOS SP 60C	BC/RI CR/RI	BS CR	E27 4x77W E27	⊥ IP20	CE	CB EAC	DIM 1	2.600,00
ECOS PL 90	BC/RI CR/RI	BS CR	E27 5x77W E27	⊥ IP20	CE	CB EAC	DIM 1	5.400,00

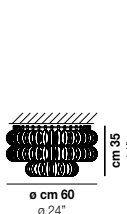

ECOS PL 60A



ECOS AP 35

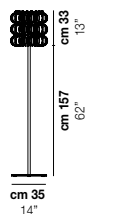

ECOS PT 35

codice / code	vetro / glass	struttura / frame	elettrificazione / lamping	CL. IP	EU cert.	International cert.	dimmer	€
ECOS PL 60A	BC/RI CR/RI	BS CR	E27 3x77W E27	⊥ IP20	CE	CB EAC	DIM 1	2.620,00
ECOS AP 35	BC/RI CR/RI	BS CR	G9 2x60W G9	⊥ IP20	CE	EAC	DIM 1	590,00
ECOS PT 35	BC/RI CR/RI	BS CR	E27 1x77W E27	⊥ IP20	CE	EAC		1.250,00

finitura vetro / glass finish | finitura struttura / frame finish

ESSENCE

design atelier oi 2015

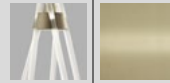

CR/SF

AB

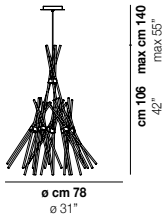

ESSENCE SP 5

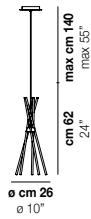

ESSENCE SP

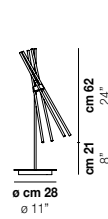

ESSENCE LT

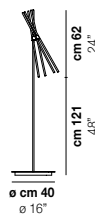

ESSENCE PT

codice / code	vetro / glass	struttura / frame	elettrificazione / lamping		CL.	IP	EU cert.	International cert.	dimmer	€
ESSENCE SP 5	CR/SF	AB	LED	6W	3125 lm	⏚	IP20	CE ERC	DIM 3	2.500,00
ESSENCE SP	CR/SF	AB	LED	5W	625 lm	⏚	IP20	CE ERC	DIM 3	355,00
ESSENCE LT	CR/SF	AB	LED	8,5W	625 lm	⏚	IP20	CE ERC	DIM 4A	500,00
ESSENCE PT	CR/SF	AB	LED	8,5W	625 lm	⏚	IP20	CE ERC		800,00

finitura vetro / glass finish | finitura struttura / frame finish

FEREA

design Babled & Co. 2009



BC/ST

BC

CR

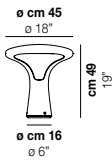

FEREA LT

codice / code	vetro / glass	struttura / frame	elettrificazione / lamping		CL.	IP	EU cert.	International cert.	dimmer	€
FEREA LT	BC/ST	BC	E27	1x205W E27	⏚	IP20	CE ERC	CCC	DIM 4A	680,00

finitura vetro / glass finish | finitura struttura / frame finish

FUTURA

design Hangar Design Group 2015

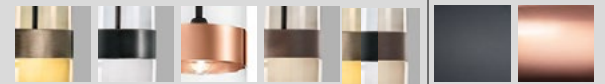

AM/OT

BC/NE

CR/RA

FU/MA

MC/1

NE

RA

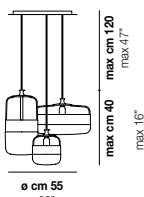

FUTURA SP 3

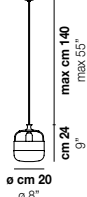

FUTURA SP P

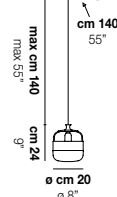

FUTURA SP P D1

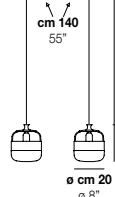

FUTURA SP P D2

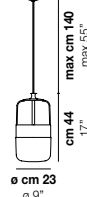

FUTURA SP M

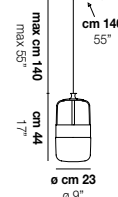



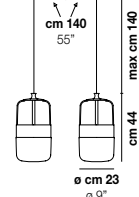













FUTURA SP M D1



FUTURA SP M D2

codice / code	vetro / glass	struttura / frame	elettrificazione / lamping		CL.	IP	EU cert.	International cert.	dimmer	€
FUTURA SP 3	MC/1 CR/RA	NE RA	E27	1x77W E27	⏚	IP20	CE CB ERC	CCC PS	DIM 1	1.600,00
FUTURA SP P	FU/MA BC/NE AM/OT CR/RA NE RA		E27	1x77W E27	⏚	IP20	CE CB ERC	CCC PS	DIM 1	305,00
FUTURA SP P D1	FU/MA BC/NE AM/OT CR/RA NE RA		E27	1x77W E27	⏚	IP20	CE CB ERC	CCC	DIM 1	345,00
FUTURA SP P D2	FU/MA BC/NE AM/OT CR/RA NE RA		E27	2x77W E27	⏚	IP20	CE CB ERC	CCC	DIM 1	660,00

codice / code	vetro / glass	struttura / frame	elettrificazione / lamping	CL. IP	EU cert.	International cert.	dimmer	€
FUTURASPM	FU/MA BC/NE AM/OT CR/RA NE RA		E27 1×77W E27	⊥ IP20	CE  CB certifiata	ERAC  UL US  CCC  PSE	DIM 1	450,00
FUTURASPM D1	FU/MA BC/NE AM/OT CR/RA NE RA		E27 1×77W E27	⊥ IP20	CE  CB certifiata	ERAC  UL US  CCC	DIM 1	490,00
FUTURASPM D	FU/MA BC/NE AM/OT CR/RA NE RA		E27 2×77W E27	⊥ IP20	CE  CB certifiata	ERAC  UL US  CCC	DIM 1	950,00
FUTURASPG	FU/MA BC/NE AM/OT CR/RA NE RA		E27 1×77W E27	⊥ IP20	CE  CB certifiata	ERAC  UL US  CCC  PSE	DIM 1	550,00
FUTURASPG D1	FU/MA BC/NE AM/OT CR/RA NE RA		E27 1×77W E27	⊥ IP20	CE  CB certifiata	ERAC  UL US  CCC	DIM 1	590,00

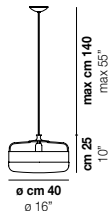

FUTURA SP G

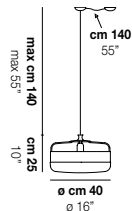

FUTURA SP G D1

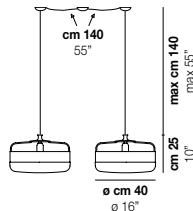

FUTURA SP G D2

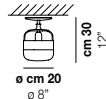



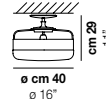



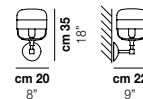







FUTURA PL P



FUTURA PL G



FUTURA AP P

codice / code	vetro / glass	struttura / frame	elettrificazione / lamping	CL. IP	EU cert.	International cert.	dimmer	€
FUTURASPG D2	FU/MA BC/NE AM/OT CR/RA NE RA		E27 2×77W E27	⊥ IP20	CE  CB certifiata	ERAC  UL US  CCC	DIM 1	1.150,00
FUTURA PL P	FU/MA BC/NE AM/OT CR/RA NE RA		E27 1×77W E27	⊥ IP20	CE  CB certifiata	ERAC  UL US  CCC  PSE	DIM 1	310,00
FUTURA PL G	FU/MA BC/NE AM/OT CR/RA NE RA		E27 1×77W E27	⊥ IP20	CE  CB certifiata	ERAC  UL US  CCC  PSE	DIM 1	570,00
FUTURA APP	FU/MA BC/NE AM/OT CR/RA NE RA		E27 1×77W E27	⊥ IP20	CE  CB certifiata	ERAC  UL US  CCC  PSE	DIM 1	325,00





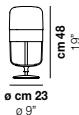

FUTURA LT P

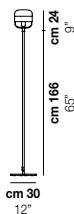

FUTURA LT M



FUTURA PT P

codice / code	vetro / glass	struttura / frame	elettrificazione / lamping	CL. IP	EU cert.	International cert.	dimmer	€
FUTURALTP	FU/MA BC/NE AM/OT CR/RA NE RA		E27 1×77W E27	□ IP20	CE  CB certifiata	ERAC  UL US  CCC	DIM 4A	355,00
FUTURALTM	FU/MA BC/NE AM/OT CR/RA NE RA		E27 1×77W E27	□ IP20	CE  CB certifiata	ERAC  UL US  CCC  PSE	DIM 4A	470,00
FUTURAPT P	FU/MA BC/NE AM/OT CR/RA NE RA		E27 1×77W E27	⊥ IP20	CE  CB certifiata	ERAC  UL US  CCC		570,00

finitura vetro / glass finish | finitura struttura / frame finish

GIOGALI3D

design Angelo Mangiarotti 2005



CR/TR

CR

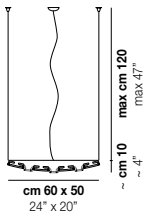

GIOGALI3D SP 50

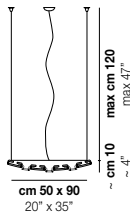

GIOGALI3D SP 90

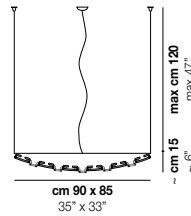

GIOGALI3D SP 100

codice / code	vetro / glass	struttura / frame	elettrificazione / lamping	CL. IP	EU cert.	International cert.	dimmer	€
GIOGALI3D SP 50	CR/TR	CR	G9 4x60W G9	⊥ IP20	CE	ERC Ⓢ CCC	DIM 1	730,00
GIOGALI3D SP 90	CR/TR	CR	G9 4x60W G9	⊥ IP20	CE	ERC Ⓢ CCC	DIM 1	1.020,00
GIOGALI3D SP 100	CR/TR	CR	G9 4x60W G9	⊥ IP20	CE	ERC Ⓢ CCC	DIM 1	1.500,00

finitura vetro / glass finish | finitura struttura / frame finish

GIOGALI

design Angelo Mangiarotti 1967



BC

CR/AG

CR/AM

CR/BR

CR/FU

CR/NN

CR/OR

CR/RA

CR/TR

NE

BR

CR

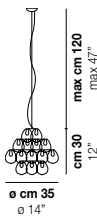

GIOGALI SP 35

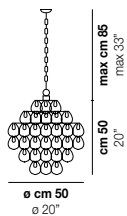

GIOGALI SP 50

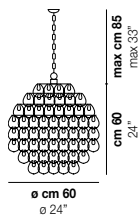

GIOGALI SP 60

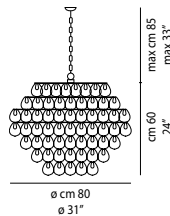

GIOGALI SP 80

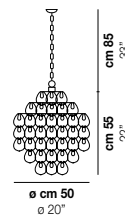

GIOGALI SP 3E

codice / code	vetro / glass	struttura / frame	elettrificazione / lamping	CL. IP	EU cert.	International cert.	dimmer	€
GIOGALI SP 35	CR/TR	BR CR	E27 1x77W E27	⊥ IP20	CE	CB Ⓢ ERC Ⓢ CCC Ⓢ PS	DIM 1	460,00
GIOGALI SP 35	BC CR/AG CR/AM CR/BR CR/FU	BR CR	E27 1x77W E27	⊥ IP20	CE	CB Ⓢ ERC Ⓢ CCC Ⓢ PS	DIM 1	570,00
GIOGALI SP 35	CR/NN CR/OR CR/RA NE	BR CR	E27 1x77W E27	⊥ IP20	CE	CB Ⓢ ERC Ⓢ CCC Ⓢ PS	DIM 1	570,00
GIOGALI SP 50	CR/TR	BR CR	E27 1x77W E27	⊥ IP20	CE	CB Ⓢ ERC Ⓢ CCC	DIM 1	1.290,00
GIOGALI SP 50	BC CR/AG CR/AM CR/BR CR/FU	BR CR	E27 1x77W E27	⊥ IP20	CE	CB Ⓢ ERC Ⓢ CCC Ⓢ PS	DIM 1	1.860,00
GIOGALI SP 50	CR/NN CR/OR CR/RA NE	BR CR	E27 1x77W E27	⊥ IP20	CE	CB Ⓢ ERC Ⓢ CCC Ⓢ PS	DIM 1	1.860,00
GIOGALI SP 60	CR/TR	BR CR	E27 3x77W E27	⊥ IP20	CE	CB Ⓢ ERC Ⓢ CCC	DIM 1	1.860,00
GIOGALI SP 60	BC CR/AG CR/AM CR/BR CR/FU	BR CR	E27 3x77W E27	⊥ IP20	CE	CB Ⓢ ERC Ⓢ CCC	DIM 1	2.340,00
GIOGALI SP 60	CR/NN CR/OR CR/RA NE	BR CR	E27 3x77W E27	⊥ IP20	CE	CB Ⓢ ERC Ⓢ CCC	DIM 1	2.340,00
GIOGALI SP 80	CR/TR	BR CR	E27 5x77W E27	⊥ IP20	CE	CB Ⓢ ERC Ⓢ CCC Ⓢ PS	DIM 1	2.990,00
GIOGALI SP 80	BC CR/AG CR/AM CR/BR CR/FU	BR CR	E27 5x77W E27	⊥ IP20	CE	CB Ⓢ ERC Ⓢ CCC Ⓢ PS	DIM 1	3.750,00
GIOGALI SP 80	CR/NN CR/OR CR/RA NE	BR CR	E27 5x77W E27	⊥ IP20	CE	CB Ⓢ ERC Ⓢ CCC Ⓢ PS	DIM 1	3.750,00
GIOGALI SP 3E	CR/TR	BR CR	E27 3x77W E27	⊥ IP20	CE	CB Ⓢ ERC Ⓢ CCC	DIM 1	1.390,00
GIOGALI SP 3E	BC CR/AG CR/AM CR/BR CR/FU	BR CR	E27 3x77W E27	⊥ IP20	CE	CB Ⓢ ERC Ⓢ CCC	DIM 1	1.760,00
GIOGALI SP 3E	CR/NN CR/OR CR/RA NE	BR CR	E27 3x77W E27	⊥ IP20	CE	CB Ⓢ ERC Ⓢ CCC	DIM 1	1.760,00

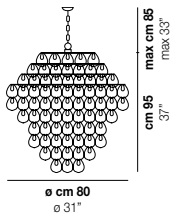

GIOGALI SP 80A

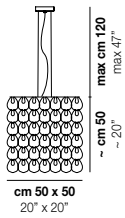

GIOGALI SP CUB

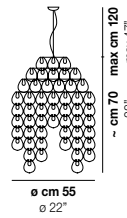

GIOGALI SP JEL

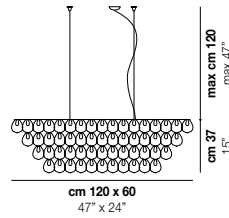

GIOGALI SP OV1

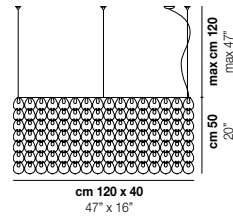

GIOGALI SP RE1 B

codice / code	vetro / glass	struttura / frame	elettrificazione / lamping	CL. IP	EU cert.	International cert.	dimmer	€
GIOGALI SP 80A	CR/TR	BR CR	E27 5x77W E27	⊥ IP20	CE CB EAC	CCC	DIM 1	3.480,00
GIOGALI SP 80A	BC CR/AG CR/AM CR/BR CR/FU	BR CR	E27 5x77W E27	⊥ IP20	CE CB EAC	CCC	DIM 1	4.410,00
GIOGALI SP 80A	CR/INN CR/OR CR/RA NE	BR CR	E27 5x77W E27	⊥ IP20	CE CB EAC	CCC	DIM 1	4.410,00
GIOGALI SP CUB	CR/TR	BR CR	E27 3x77W E27	⊥ IP20	CE CB EAC	CCC PSE	DIM 1	2.140,00
GIOGALI SP CUB	BC CR/AG CR/AM CR/BR CR/FU	BR CR	E27 3x77W E27	⊥ IP20	CE CB EAC	CCC PSE	DIM 1	2.760,00
GIOGALI SP CUB	CR/INN CR/OR CR/RA NE	BR CR	E27 3x77W E27	⊥ IP20	CE CB EAC	CCC PSE	DIM 1	2.760,00
GIOGALI SP JEL	CR/TR	BR CR	E27 1x77W E27	⊥ IP20	CE CB EAC	CCC	DIM 1	1.730,00
GIOGALI SP JEL	BC CR/AG CR/AM CR/BR CR/FU	BR CR	E27 1x77W E27	⊥ IP20	CE CB EAC	CCC	DIM 1	2.210,00
GIOGALI SP JEL	CR/INN CR/OR CR/RA NE	BR CR	E27 1x77W E27	⊥ IP20	CE CB EAC	CCC	DIM 1	2.210,00
GIOGALI SP OV1	CR/TR	BR CR	E27 4x77W E27	⊥ IP20	CE CB EAC	CCC	DIM 1	2.480,00
GIOGALI SP OV1	BC CR/AG CR/AM CR/BR CR/FU	BR CR	E27 4x77W E27	⊥ IP20	CE CB EAC	CCC	DIM 1	3.060,00
GIOGALI SP OV1	CR/INN CR/OR CR/RA NE	BR CR	E27 4x77W E27	⊥ IP20	CE CB EAC	CCC	DIM 1	3.060,00
GIOGALI SP R1B	CR/TR	BR CR	E27 10x77W E27	⊥ IP20	CE CB EAC	CCC	DIM 1	2.830,00
GIOGALI SP R1B	BC CR/AG CR/AM CR/BR CR/FU	BR CR	E27 10x77W E27	⊥ IP20	CE CB EAC	CCC	DIM 1	3.540,00
GIOGALI SP R1B	CR/INN CR/OR CR/RA NE	BR CR	E27 10x77W E27	⊥ IP20	CE CB EAC	CCC	DIM 1	3.540,00

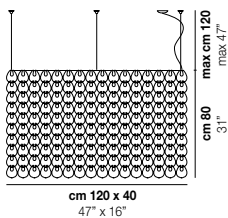

GIOGALI SP RE1

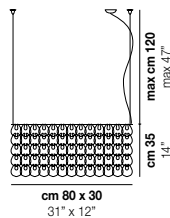

GIOGALI SP RE2

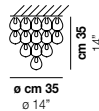

GIOGALI PL 35

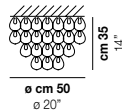

GIOGALI PL 50

codice / code	vetro / glass	struttura / frame	elettrificazione / lamping	CL. IP	EU cert.	International cert.	dimmer	€
GIOGALI SP RE1	CR/TR	BR CR	E27 10x77W E27	⊥ IP20	CE CB EAC	CCC	DIM 1	3.880,00
GIOGALI SP RE1	BC CR/AG CR/AM CR/BR CR/FU	BR CR	E27 10x77W E27	⊥ IP20	CE CB EAC	CCC	DIM 1	4.930,00
GIOGALI SP RE1	CR/INN CR/OR CR/RA NE	BR CR	E27 10x77W E27	⊥ IP20	CE CB EAC	CCC	DIM 1	4.930,00
GIOGALI SP RE2	CR/TR	BR CR	E27 3x77W E27	⊥ IP20	CE CB EAC	CCC PSE	DIM 1	1.490,00
GIOGALI SP RE2	BC CR/AG CR/AM CR/BR CR/FU	BR CR	E27 3x77W E27	⊥ IP20	CE CB EAC	CCC PSE	DIM 1	1.810,00
GIOGALI SP RE2	CR/INN CR/OR CR/RA NE	BR CR	E27 3x77W E27	⊥ IP20	CE CB EAC	CCC PSE	DIM 1	1.810,00
GIOGALI PL 35	CR/TR	BR CR	E14 2x60W E14	⊥ IP20	CE CB EAC	CCC PSE	DIM 1	590,00
GIOGALI PL 35	BC CR/AG CR/AM CR/BR CR/FU	BR CR	E14 2x60W E14	⊥ IP20	CE CB EAC	CCC PSE	DIM 1	720,00
GIOGALI PL 35	CR/INN CR/OR CR/RA NE	BR CR	E14 2x60W E14	⊥ IP20	CE CB EAC	CCC PSE	DIM 1	720,00
GIOGALI PL 50	CR/TR	BR CR	E27 4x77W E27	⊥ IP20	CE CB EAC	CCC PSE	DIM 1	1.030,00
GIOGALI PL 50	BC CR/AG CR/AM CR/BR CR/FU	BR CR	E27 4x77W E27	⊥ IP20	CE CB EAC	CCC PSE	DIM 1	1.290,00
GIOGALI PL 50	CR/INN CR/OR CR/RA NE	BR CR	E27 4x77W E27	⊥ IP20	CE CB EAC	CCC PSE	DIM 1	1.290,00

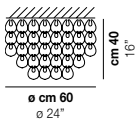

GIOGALI PL 60

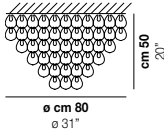

GIOGALI PL 80

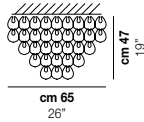

GIOGALI PL 65Q

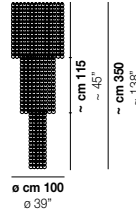

GIOGALI PL CA1

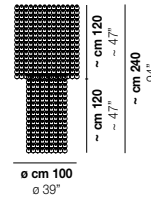

GIOGALI PL CA2

codice / code	vetro / glass	struttura / frame	elettrificazione / lamping	CL. IP	EU cert.	International cert.	dimmer	€
GIOGALI PL 60	CR/TR	BR CR	E27 4x77W E27	⊥ IP20	CE CB	ERAC	DIM 1	1.530,00
GIOGALI PL 60	BC CR/AG CR/AM CR/BR CR/FU	BR CR	E27 4x77W E27	⊥ IP20	CE CB	ERAC	DIM 1	1.920,00
GIOGALI PL 60	CR/NN CR/OR CR/RA NE	BR CR	E27 4x77W E27	⊥ IP20	CE CB	ERAC	DIM 1	1.920,00
GIOGALI PL 80	CR/TR	BR CR	E27 5x77W E27	⊥ IP20	CE CB	ERAC	DIM 1	2.250,00
GIOGALI PL 80	BC CR/AG CR/AM CR/BR CR/FU	BR CR	E27 5x77W E27	⊥ IP20	CE CB	ERAC	DIM 1	2.830,00
GIOGALI PL 80	CR/NN CR/OR CR/RA NE	BR CR	E27 5x77W E27	⊥ IP20	CE CB	ERAC	DIM 1	2.830,00
GIOGALI PL 65Q	CR/TR	BR CR	E27 4x77W E27	⊥ IP20	CE	ERAC	DIM 1	1.800,00
GIOGALI PL 65Q	BC CR/AG CR/AM CR/BR CR/FU	BR CR	E27 4x77W E27	⊥ IP20	CE CB	ERAC	DIM 1	2.280,00
GIOGALI PL 65Q	CR/NN CR/OR CR/RA NE	BR CR	E27 4x77W E27	⊥ IP20	CE CB	ERAC	DIM 1	2.280,00
GIOGALI PL CA1	CR/TR	BR CR	E27 10x77W E27	⊥ IP20	CE CB	ERAC	DIM 1	9.880,00
GIOGALI PL CA1	BC CR/AG CR/AM CR/BR CR/FU	BR CR	E27 10x77W E27	⊥ IP20	CE CB	ERAC	DIM 1	12.800,00
GIOGALI PL CA1	CR/NN CR/OR CR/RA NE	BR CR	E27 10x77W E27	⊥ IP20	CE CB	ERAC	DIM 1	12.800,00
GIOGALI PL CA2	CR/TR	BR CR	E27 10x77W E27	⊥ IP20	CE CB	ERAC	DIM 1	8.530,00
GIOGALI PL CA2	BC CR/AG CR/AM CR/BR CR/FU	BR CR	E27 10x77W E27	⊥ IP20	CE CB	ERAC	DIM 1	11.030,00
GIOGALI PL CA2	CR/NN CR/OR CR/RA NE	BR CR	E27 10x77W E27	⊥ IP20	CE CB	ERAC	DIM 1	11.030,00

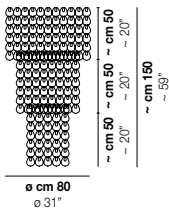

GIOGALI PL CA3

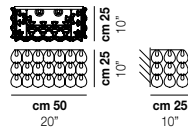

GIOGALI AP 2

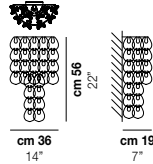

GIOGALI AP

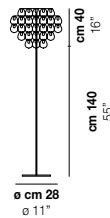

GIOGALI PT



GIOGALI

codice / code	vetro / glass	struttura / frame	elettrificazione / lamping	CL. IP	EU cert.	International cert.	dimmer	€
GIOGALI PL CA3	CR/TR	BR CR	E27 7x77W E27	⊥ IP20	CE CB	ERAC	DIM 1	5.220,00
GIOGALI PL CA3	BC CR/AG CR/AM CR/BR CR/FU	BR CR	E27 7x77W E27	⊥ IP20	CE CB	ERAC	DIM 1	6.640,00
GIOGALI PL CA3	CR/NN CR/OR CR/RA NE	BR CR	E27 7x77W E27	⊥ IP20	CE CB	ERAC	DIM 1	6.640,00
GIOGALI AP 2	CR/TR	BR CR	E27 2x77W E27	⊥ IP20	CE CB	ERAC	DIM 1	630,00
GIOGALI AP 2	BC CR/AG CR/AM CR/BR CR/FU	BR CR	E27 2x77W E27	⊥ IP20	CE CB	ERAC	DIM 1	750,00
GIOGALI AP 2	CR/NN CR/OR CR/RA NE	BR CR	E27 2x77W E27	⊥ IP20	CE CB	ERAC	DIM 1	750,00
GIOGALI AP	CR/TR	BR CR	E14 1x60W E14	⊥ IP20	CE CB	ERAC	DIM 1	460,00
GIOGALI AP	BC CR/AG CR/AM CR/BR CR/FU	BR CR	E14 1x60W E14	⊥ IP20	CE CB	ERAC	DIM 1	570,00
GIOGALI AP	CR/NN CR/OR CR/RA NE	BR CR	E14 1x60W E14	⊥ IP20	CE CB	ERAC	DIM 1	570,00
GIOGALI PT	CR/TR	BR CR	E27 3x77W E27	⊥ IP20	CE CB	ERAC	DIM 1	1.480,00
GIOGALI PT	BC CR/AG CR/AM CR/BR CR/FU	BR CR	E27 3x77W E27	⊥ IP20	CE CB	ERAC	DIM 1	1.770,00
GIOGALI PT	CR/NN CR/OR CR/RA NE	BR CR	E27 3x77W E27	⊥ IP20	CE CB	ERAC	DIM 1	1.770,00
GIOGALI	CR/TR	BR CR						6,00
GIOGALI	BC CR/AG CR/AM CR/BR CR/FU	BR CR						8,00
GIOGALI	CR/NN CR/OR CR/RA NE	BR CR						8,00

finitura vetro / glass finish finitura struttura / frame finish

MINIGIOGALI

design Angelo Mangiarotti 1967

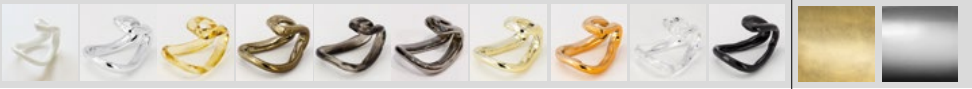

BC CR/AG CR/AM CR/BR CR/FU CR/NN CR/OR CR/RA CR/TR NE BR CR

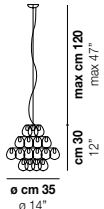

MINIGIOGALI SP 35

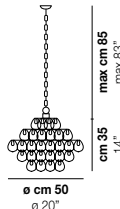

MINIGIOGALI SP 50

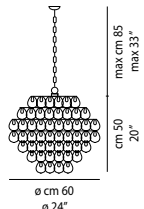

MINIGIOGALI SP 60

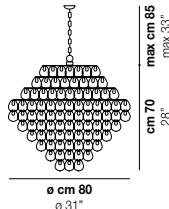

MINIGIOGALI SP 80

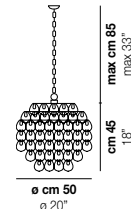

MINIGIOGALI SP 3E

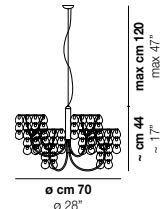

MINIGIOGALI SP CHA

codice / code	vetro / glass	struttura / frame	elettrificazione / lamping	CL. IP	EU cert.	International cert.	dimmer	€
MINIGIOGALI SP 35	CR/TR	BR CR	E27 1x77W E27	⊥ IP20	CE CB EAC	ERC	DIM 1	610,00
MINIGIOGALI SP 35	BC CR/AG CR/AM CR/BR CR/FU	BR CR	E27 1x77W E27	⊥ IP20	CE CB EAC	ERC	DIM 1	800,00
MINIGIOGALI SP 35	CR/NN CR/OR CR/RA NE	BR CR	E27 1x77W E27	⊥ IP20	CE CB EAC	ERC	DIM 1	800,00
MINIGIOGALI SP 50	CR/TR	BR CR	E27 1x77W E27	⊥ IP20	CE CB EAC	ERC	DIM 1	1.170,00
MINIGIOGALI SP 50	BC CR/AG CR/AM CR/BR CR/FU	BR CR	E27 1x77W E27	⊥ IP20	CE CB EAC	ERC	DIM 1	1.530,00
MINIGIOGALI SP 50	CR/NN CR/OR CR/RA NE	BR CR	E27 1x77W E27	⊥ IP20	CE CB EAC	ERC	DIM 1	1.530,00
MINIGIOGALI SP 60	CR/TR	BR CR	E27 3x77W E27	⊥ IP20	CE CB EAC	ERC	DIM 1	1.880,00
MINIGIOGALI SP 60	BC CR/AG CR/AM CR/BR CR/FU	BR CR	E27 3x77W E27	⊥ IP20	CE CB EAC	ERC	DIM 1	2.440,00
MINIGIOGALI SP 60	CR/NN CR/OR CR/RA NE	BR CR	E27 3x77W E27	⊥ IP20	CE CB EAC	ERC	DIM 1	2.440,00
MINIGIOGALI SP 80	CR/TR	BR CR	E27 5x77W E27	⊥ IP20	CE CB EAC	ERC	DIM 1	3.660,00
MINIGIOGALI SP 80	BC CR/AG CR/AM CR/BR CR/FU	BR CR	E27 5x77W E27	⊥ IP20	CE CB EAC	ERC	DIM 1	4.780,00
MINIGIOGALI SP 80	CR/NN CR/OR CR/RA NE	BR CR	E27 5x77W E27	⊥ IP20	CE CB EAC	ERC	DIM 1	4.780,00
MINIGIOGALI SP 3E	CR/TR	BR CR	E27 3x77W E27	⊥ IP20	CE CB EAC	ERC	DIM 1	1.250,00
MINIGIOGALI SP 3E	BC CR/AG CR/AM CR/BR CR/FU	BR CR	E27 3x77W E27	⊥ IP20	CE CB EAC	ERC	DIM 1	1.620,00
MINIGIOGALI SP 3E	CR/NN CR/OR CR/RA NE	BR CR	E27 3x77W E27	⊥ IP20	CE CB EAC	ERC	DIM 1	1.620,00
MINIGIOGALI SP CHA	CR/TR	BR CR	G9 6x60W G9	⊥ IP20	CE CB EAC	ERC	DIM 1	1.880,00
MINIGIOGALI SP CHA	BC CR/AG CR/AM CR/BR CR/FU	BR CR	G9 6x60W G9	⊥ IP20	CE CB EAC	ERC	DIM 1	2.420,00
MINIGIOGALI SP CHA	CR/NN CR/OR CR/RA NE	BR CR	G9 6x60W G9	⊥ IP20	CE CB EAC	ERC	DIM 1	2.420,00

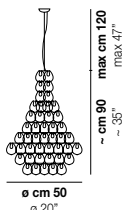

MINIGIOGALI SP CLA

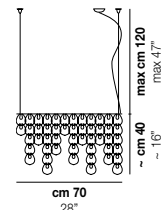

MINIGIOGALI SP CLO

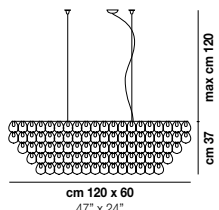

MINIGIOGALI SP OV1

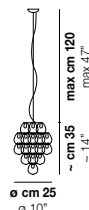

MINIGIOGALI SP RAI

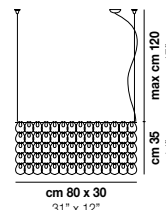

MINIGIOGALI SP RE2

codice / code	vetro / glass	struttura / frame	elettrificazione / lamping	CL. IP	EU cert.	International cert.	dimmer	€
MINIGIOGALI SP CLA	CR/TR	BR CR	E27 3x77W E27	⊥ IP20	CE CB EAC	ERC	DIM 1	2.110,00
MINIGIOGALI SP CLA	BC CR/AG CR/AM CR/BR CR/FU	BR CR	E27 3x77W E27	⊥ IP20	CE CB EAC	ERC	DIM 1	2.690,00
MINIGIOGALI SP CLA	CR/NN CR/OR CR/RA NE	BR CR	E27 3x77W E27	⊥ IP20	CE CB EAC	ERC	DIM 1	2.690,00
MINIGIOGALI SP CLO	CR/TR	BR CR	G9 3x60W G9	⊥ IP20	CE CB EAC	ERC	DIM 1	2.000,00
MINIGIOGALI SP CLO	BC CR/AG CR/AM CR/BR CR/FU	BR CR	G9 3x60W G9	⊥ IP20	CE CB EAC	ERC	DIM 1	2.540,00
MINIGIOGALI SP CLO	CR/NN CR/OR CR/RA NE	BR CR	G9 3x60W G9	⊥ IP20	CE CB EAC	ERC	DIM 1	2.540,00
MINIGIOGALI SP OV1	CR/TR	BR CR	E27 4x77W E27	⊥ IP20	CE CB EAC	ERC	DIM 1	3.600,00
MINIGIOGALI SP OV1	BC CR/AG CR/AM CR/BR CR/FU	BR CR	E27 4x77W E27	⊥ IP20	CE CB EAC	ERC	DIM 1	4.680,00

codice / code	vetro / glass	struttura / frame	elettrificazione / lamping	CL. IP	EU cert.	International cert.	dimmer	€
MINIGIOGALISPOV1	CR/NN CR/OR CR/RA NE	BR CR	E27 4x77W E27	⊥ IP20	CE CB EAC	ERC	DIM 1	4.680,00
MINIGIOGALISPRAI	CR/TR	BR CR	G9 1x60W G9	⊥ IP20	CE CB EAC	ERC	DIM 1	305,00
MINIGIOGALISPRAI	BC CR/AG CR/AM CR/BR CR/FU	BR CR	G9 1x60W G9	⊥ IP20	CE CB EAC	ERC	DIM 1	370,00
MINIGIOGALISPRAI	CR/NN CR/OR CR/RA NE	BR CR	G9 1x60W G9	⊥ IP20	CE CB EAC	ERC	DIM 1	370,00
MINIGIOGALISPRE2	CR/TR	BR CR	E27 3x77W E27	⊥ IP20	CE CB EAC	ERC	DIM 1	1.490,00
MINIGIOGALISPRE2	BC CR/AG CR/AM CR/BR CR/FU	BR CR	E27 3x77W E27	⊥ IP20	CE CB EAC	ERC	DIM 1	1.860,00
MINIGIOGALISPRE2	CR/NN CR/OR CR/RA NE	BR CR	E27 3x77W E27	⊥ IP20	CE CB EAC	ERC	DIM 1	1.860,00

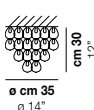

MINIGIOGALI PL 35

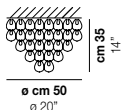

MINIGIOGALI PL 50

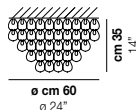

MINIGIOGALI PL 60

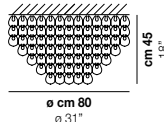

MINIGIOGALI PL 80

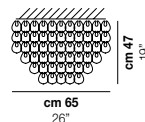

MINIGIOGALI PL 65Q

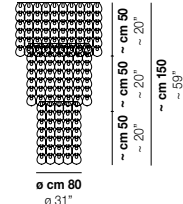

MINIGIOGALI PL CA3

codice / code	vetro / glass	struttura / frame	elettrificazione / lamping	CL. IP	EU cert.	International cert.	dimmer	€
MINIGIOGALIPL35	CR/TR	BR CR	E14 2x60W E14	⊥ IP20	CE CB EAC	ERC	DIM 1	800,00
MINIGIOGALIPL35	BC CR/AG CR/AM CR/BR CR/FU	BR CR	E14 2x60W E14	⊥ IP20	CE CB EAC	ERC	DIM 1	1.030,00
MINIGIOGALIPL35	CR/NN CR/OR CR/RA NE	BR CR	E14 2x60W E14	⊥ IP20	CE CB EAC	ERC	DIM 1	1.030,00
MINIGIOGALIPL50	CR/TR	BR CR	E27 4x77W E27	⊥ IP20	CE CB EAC	ERC	DIM 1	1.130,00
MINIGIOGALIPL50	BC CR/AG CR/AM CR/BR CR/FU	BR CR	E27 4x77W E27	⊥ IP20	CE CB EAC	ERC	DIM 1	1.460,00
MINIGIOGALIPL50	CR/NN CR/OR CR/RA NE	BR CR	E27 4x77W E27	⊥ IP20	CE CB EAC	ERC	DIM 1	1.460,00
MINIGIOGALIPL60	CR/TR	BR CR	E27 4x77W E27	⊥ IP20	CE CB EAC	ERC	DIM 1	1.740,00
MINIGIOGALIPL60	BC CR/AG CR/AM CR/BR CR/FU	BR CR	E27 4x77W E27	⊥ IP20	CE CB EAC	ERC	DIM 1	2.250,00
MINIGIOGALIPL60	CR/NN CR/OR CR/RA NE	BR CR	E27 4x77W E27	⊥ IP20	CE CB EAC	ERC	DIM 1	2.250,00
MINIGIOGALIPL80	CR/TR	BR CR	E27 5x77W E27	⊥ IP20	CE CB EAC	ERC	DIM 1	3.040,00
MINIGIOGALIPL80	BC CR/AG CR/AM CR/BR CR/FU	BR CR	E27 5x77W E27	⊥ IP20	CE CB EAC	ERC	DIM 1	4.000,00
MINIGIOGALIPL80	CR/NN CR/OR CR/RA NE	BR CR	E27 5x77W E27	⊥ IP20	CE CB EAC	ERC	DIM 1	4.000,00
MINIGIOGALIPL65Q	CR/TR	BR CR	E27 4x77W E27	⊥ IP20	CE CB EAC	ERC	DIM 1	2.470,00
MINIGIOGALIPL65Q	BC CR/AG CR/AM CR/BR CR/FU	BR CR	E27 4x77W E27	⊥ IP20	CE CB EAC	ERC	DIM 1	3.270,00
MINIGIOGALIPL65Q	CR/NN CR/OR CR/RA NE	BR CR	E27 4x77W E27	⊥ IP20	CE CB EAC	ERC	DIM 1	3.270,00
MINIGIOGALIPLCA3	CR/TR	BR CR	E27 7x77W E27	⊥ IP20	CE CB EAC	ERC	DIM 1	6.290,00
MINIGIOGALIPLCA3	BC CR/AG CR/AM CR/BR CR/FU	BR CR	E27 7x77W E27	⊥ IP20	CE CB EAC	ERC	DIM 1	8.330,00
MINIGIOGALIPLCA3	CR/NN CR/OR CR/RA NE	BR CR	E27 7x77W E27	⊥ IP20	CE CB EAC	ERC	DIM 1	8.330,00

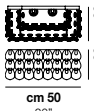

MINIGIOGALI AP 2



MINIGIOGALI AP

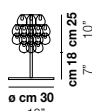

MINIGIOGALI LT

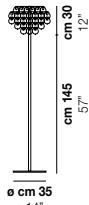

MINIGIOGALI PT



MINIGIOGALI

codice / code	vetro / glass	struttura / frame	elettrificazione / lamping	CL. IP	EU cert.	International cert.	dimmer	€
MINIGIOGALIAP 2	CR/TR	BR CR	E27 2x77W E27	⊥ IP20	CE CB EAC	ERC	DIM 1	630,00
MINIGIOGALIAP 2	BC CR/AG CR/AM CR/BR CR/FU	BR CR	E27 2x77W E27	⊥ IP20	CE CB EAC	ERC	DIM 1	770,00
MINIGIOGALIAP 2	CR/NN CR/OR CR/RA NE	BR CR	E27 2x77W E27	⊥ IP20	CE CB EAC	ERC	DIM 1	770,00

codice / code	vetro / glass	struttura / frame	elettrificazione / lamping	CL. IP	EU cert.	International cert.	dimmer	€
MINIGIOGALIAP	CR/TR	BR CR	E14 1×60W E14	⊥ IP20	CE	ERC c(UL)us (CC)	DIM 1	455,00
MINIGIOGALIAP	BC CR/AG CR/AM CR/BR CR/FU	BR CR	E14 1×60W E14	⊥ IP20	CE	ERC c(UL)us (CC)	DIM 1	580,00
MINIGIOGALIAP	CR/NN CR/OR CR/RA NE	BR CR	E14 1×60W E14	⊥ IP20	CE	ERC c(UL)us (CC)	DIM 1	580,00
MINIGIOGALILT	CR/TR	CR BR	E27 1×77W E27	⊥ IP20	CE	ERC c(UL)us (CC) (PS)	DIM 4A	510,00
MINIGIOGALILT	BC CR/AG CR/AM CR/BR CR/FU	BR CR	E27 1×77W E27	⊥ IP20	CE	ERC c(UL)us (CC) (PS)	DIM 4A	620,00
MINIGIOGALILT	CR/NN CR/OR CR/RA NE	BR CR	E27 1×77W E27	⊥ IP20	CE	ERC c(UL)us (CC) (PS)	DIM 4A	620,00
MINIGIOGALIPT	CR/TR	BR CR	E27 3×77W E27	⊥ IP20	CE	ERC c(UL)us (CC) (PS)		1.860,00
MINIGIOGALIPT	BC CR/AG CR/AM CR/BR CR/FU	BR CR	E27 3×77W E27	⊥ IP20	CE	ERC c(UL)us (CC) (PS)		2.330,00
MINIGIOGALIPT	CR/NN CR/OR CR/RA NE	BR CR	E27 3×77W E27	⊥ IP20	CE	ERC c(UL)us (CC) (PS)		2.330,00
MINIGIOGALI	CR/TR	BR CR						4,20
MINIGIOGALI	BC CR/AG CR/AM CR/BR CR/FU	BR CR						5,80
MINIGIOGALI	CR/NN CR/OR CR/RA NE	BR CR						5,80

finitura vetro / glass finish | finitura struttura / frame finish

GLORIA

studio tecnico Vetreria Vistosi 2002



SE/OR



BC

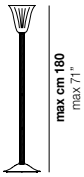

OR

ø cm 40
ø 16"

GLORIA PT

codice / code	vetro / glass	struttura / frame	elettrificazione / lamping	CL. IP	EU cert.	International cert.	dimmer	€
GLORIAPT	SE/OR	OR	E27 1×205W E27	⊥ IP20	CE	ERC (CC)		1.230,00

finitura vetro / glass finish | finitura struttura / frame finish



BC/CR



BC

GOCCIA

studio tecnico Vetreria Vistosi 2002

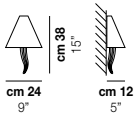
cm 24
9"cm 12
5"

GOCCIA AP

codice / code	vetro / glass	struttura / frame	elettrificazione / lamping	CL. IP	EU cert.	International cert.	dimmer	€
GOCCIAAP	BC/CR	BC	E27 1×77W E27	⊥ IP20	CE	CB CERTIFIED EAC c(UL)us (CC)	DIM 1	290,00

finitura vetro / glass finish

GOTO

studio tecnico Vetreria Vistosi 2002



BC

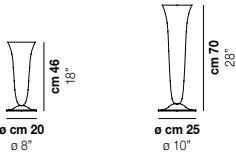

GOTO LT P

GOTO LT G

codice / code	vetro / glass	struttura / frame	elettrificazione / lamping	CL. IP	EU cert.	International cert.	dimmer	€
GOTOLT P	BC		E27 1x77W E27	□ IP20	CE	ERAC	DIM 4A	270,00
GOTOLT P	SE/OR	OR	E27 1x77W E27	□ IP20	CE	ERAC	DIM 4A	385,00
GOTOLT G	BC		E27 1x77W E27	□ IP20	CE	ERAC	DIM 4A	425,00
GOTOLT G	SE/OR	OR	E27 1x77W E27	□ IP20	CE	ERAC	DIM 4A	560,00

finitura vetro / glass finish

finitura struttura / frame finish

IMPLODE

design Gregorio Spini 2011



BC/CR

BC

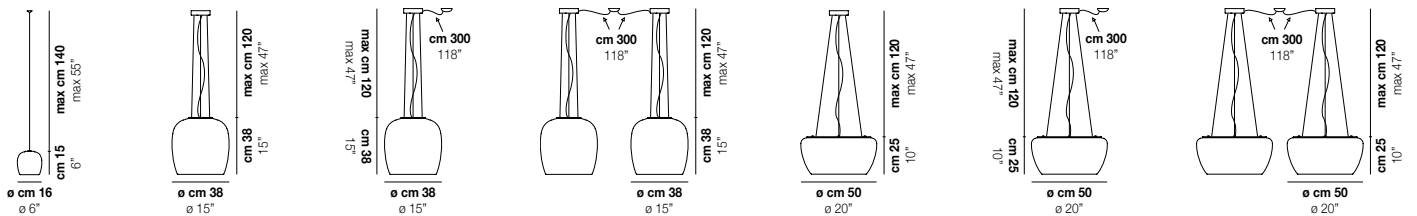

IMPLODE SP 16

IMPLODE SP 38

IMPLODE SP 38 D1

IMPLODE SP 38 D2

IMPLODE SP 50

IMPLODE SP 50 D1

IMPLODE SP 50 D2

codice / code	vetro / glass	struttura / frame	elettrificazione / lamping	CL. IP	EU cert.	International cert.	dimmer	€
IMPLODESP16	BC/CR	BC	G9 1x60W G9	□ IP20	CE CB	ERAC	DIM 1	250,00
IMPLODESP16	BC/CR	BC	LED B 5W 600 lm 2.700 K	□ IP20	CE CB	ERAC	DIM 3	400,00
IMPLODESP38	BC/CR	BC	E27 3x77W E27	⊥ IP20	CE CB	ERAC	DIM 1	610,00
IMPLODESP38	BC/CR	BC	LED F 12,5W 1650 lm 3.000 K	⊥ IP20	CE CB	ERAC	DIM 3	715,00
IMPLODESP38	BC/CR	BC	LED I 10W 1120 lm 3.000 K	⊥ IP20	CE CB	ERAC	DIM 2	695,00
IMPLODESP38D1	BC/CR	BC	E27 3x77W E27	⊥ IP20	CE CB	ERAC	DIM 1	630,00
IMPLODESP38D1	BC/CR	BC	LED F 12,5W 1650 lm 3.000 K	⊥ IP20	CE CB	ERAC	DIM 3	735,00
IMPLODESP38D1	BC/CR	BC	LED I 10W 1120 lm 3.000 K	⊥ IP20	CE CB	ERAC	DIM 2	715,00
IMPLODESP38D2	BC/CR	BC	E27 6x77W E27	⊥ IP20	CE CB	ERAC	DIM 1	1.230,00
IMPLODESP50	BC/CR	BC	E27 3x77W E27	⊥ IP20	CE CB	ERAC	DIM 1	680,00
IMPLODESP50	BC/CR	BC	LED N 10W 1120 lm 3.000 K	⊥ IP20	CE CB	ERAC	DIM 2	780,00
IMPLODESP50	BC/CR	BC	LED O 19,5W 2850 lm 3.000 K	⊥ IP20	CE CB	ERAC	DIM 3	830,00
IMPLODESP50D1	BC/CR	BC	E27 3x77W E27	⊥ IP20	CE CB	ERAC	DIM 1	710,00
IMPLODESP50D1	BC/CR	BC	LED N 10W 1120 lm 3.000 K	⊥ IP20	CE CB	ERAC	DIM 2	810,00
IMPLODESP50D1	BC/CR	BC	LED O 19,5W 2850 lm 3.000 K	⊥ IP20	CE CB	ERAC	DIM 3	860,00
IMPLODESP50D2	BC/CR	BC	E27 6x77W E27	⊥ IP20	CE CB	ERAC	DIM 1	1.400,00

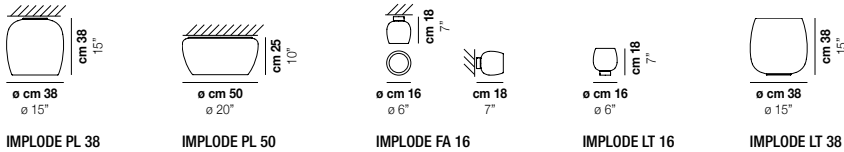

codice / code	vetro / glass	struttura / frame	elettrificazione / lamping	CL. IP	EU cert.	International cert.	dimmer	€
IMplodePL38	BC/CR	BC	E27 3×77W E27	⊥ IP20	CE CB EAC		DIM 1	480,00
IMplodePL38	BC/CR	BC	LED F 12,5W 1650 lm 3.000 K	⊥ IP20	CE CB EAC		DIM 3	580,00
IMplodePL38	BC/CR	BC	LED I 10W 1120 lm 3.000 K	⊥ IP20	CE CB EAC		DIM 2	565,00
IMplodePL50	BC/CR	BC	E27 3×77W E27	⊥ IP20	CE CB EAC		DIM 1	580,00
IMplodePL50	BC/CR	BC	LED N 10W 1120 lm 3.000 K	⊥ IP20	CE CB EAC		DIM 2	680,00
IMplodePL50	BC/CR	BC	LED O 19,5W 2850 lm 3.000 K	⊥ IP20	CE CB EAC		DIM 3	720,00
IMplodeFA16	BC/CR	BC	G9 1×60W G9	⊥ IP20	CE CB EAC		DIM 1	220,00
IMplodeFA16	BC/CR	BC	LED D 5W 600 lm 2.700 K	⊥ IP20	CE CB EAC		DIM 3	370,00
IMplodeLT16	BC/CR	BC	G9 1×60W G9	⊥ IP20	CE EAC		DIM 4A	260,00
IMplodeLT38	BC/CR	BC	E27 3×77W E27	⊥ IP20	CE CB EAC		DIM 4A	570,00

finitura vetro / glass finish | finitura struttura / frame finish

INFINITA

design Renato Toso, Noti Massari & Associati 2009



BC/ST

BC

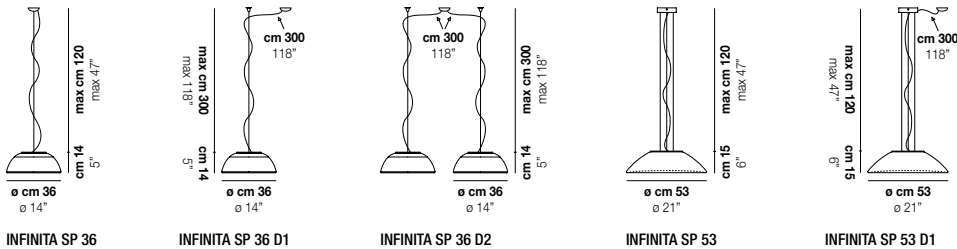

codice / code	vetro / glass	struttura / frame	elettrificazione / lamping	CL. IP	EU cert.	International cert.	dimmer	€
INFINITASP36	BC/ST	BC	E27 1×77W E27	⊥ IP20	CE CB EAC		DIM 1	280,00
INFINITASP36	BC/ST	BC	LED F 12,5W 1650 lm 3.000 K	⊥ IP20	CE CB EAC		DIM 3	385,00
INFINITASP36	BC/ST	BC	LED I 10W 1120 lm 3.000 K	⊥ IP20	CE CB EAC		DIM 2	365,00
INFINITASP36D1	BC/ST	BC	E27 1×77W E27	⊥ IP20	CE CB EAC		DIM 1	300,00
INFINITASP36D1	BC/ST	BC	LED F 12,5W 1650 lm 3.000 K	⊥ IP20	CE CB EAC		DIM 3	405,00
INFINITASP36D1	BC/ST	BC	LED I 10W 1120 lm 3.000 K	⊥ IP20	CE CB EAC		DIM 2	385,00
INFINITASP36D2	BC/ST	BC	E27 2×77W E27	⊥ IP20	CE CB EAC		DIM 1	580,00
INFINITASP53	BC/ST	BC	E27 2×77W E27	⊥ IP20	CE CB EAC		DIM 1	380,00
INFINITASP53	BC/ST	BC	LED G 19,5W 2850 lm 3.000 K	⊥ IP20	CE CB EAC		DIM 3	510,00
INFINITASP53	BC/ST	BC	LED J 10W 1120 lm 3.000 K	⊥ IP20	CE CB EAC		DIM 2	490,00
INFINITASP53D1	BC/ST	BC	E27 2×77W E27	⊥ IP20	CE CB EAC		DIM 1	415,00
INFINITASP53D1	BC/ST	BC	LED G 19,5W 2850 lm 3.000 K	⊥ IP20	CE CB EAC		DIM 3	545,00
INFINITASP53D1	BC/ST	BC	LED J 10W 1120 lm 3.000 K	⊥ IP20	CE CB EAC		DIM 2	525,00

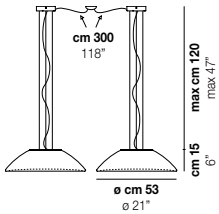

INFINITA SP 53 D2

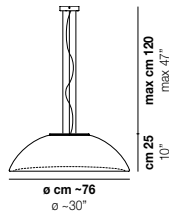

INFINITA SP 80

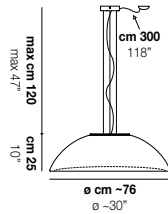

INFINITA SP 80 D1

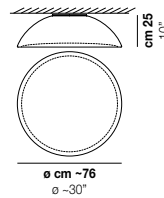

INFINITA PL 80

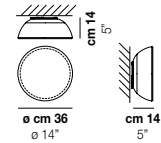

INFINITA PP 36

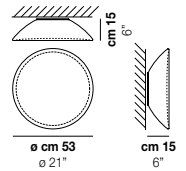

INFINITA PP 53

codice / code	vetro / glass	struttura / frame	elettrificazione / lamping	CL. IP	EU cert.	International cert.	dimmer	€
INFINITA SP 53 D2	BC/ST	BC	E27 4x77W E27	⊥ IP20	CE CB EAC	ERC	DIM 1	810,00
INFINITA SP 80	BC/ST	BC	E27 5x77W E27	⊥ IP20	CE CB EAC	ERC	DIM 1	1.190,00
INFINITA SP 80	BC/ST	BC	LED N 10W 1120 lm 3.000 K	⊥ IP20	CE CB EAC	ERC	DIM 2	1.290,00
INFINITA SP 80	BC/ST	BC	LED O 19,5W 2850 lm 3.000 K	⊥ IP20	CE CB EAC	ERC	DIM 3	1.340,00
INFINITA SP 80 D1	BC/ST	BC	E27 5x77W E27	⊥ IP20	CE CB EAC	ERC	DIM 1	1.230,00
INFINITA SP 80 D1	BC/ST	BC	LED N 10W 1120 lm 3.000 K	⊥ IP20	CE CB EAC	ERC	DIM 2	1.330,00
INFINITA SP 80 D1	BC/ST	BC	LED O 19,5W 2850 lm 3.000 K	⊥ IP20	CE CB EAC	ERC	DIM 3	1.380,00
INFINITA PL 80	BC/ST	BC	E27 5x77W E27	⊥ IP20	CE CB EAC	ERC	DIM 1	1.070,00
INFINITA PL 80	BC/ST	BC	LED N 10W 1120 lm 3.000 K	⊥ IP20	CE CB EAC	ERC	DIM 2	1.170,00
INFINITA PL 80	BC/ST	BC	LED O 19,5W 2850 lm 3.000 K	⊥ IP20	CE CB EAC	ERC	DIM 3	1.210,00
INFINITA PP 36	BC/ST	BC	E27 1x77W E27	⊥ IP20	CE CB EAC	ERC	DIM 1	198,00
INFINITA PP 36	BC/ST	BC	LED F 12,5W 1650 lm 3.000 K	⊥ IP20	CE CB EAC	ERC	DIM 3	298,00
INFINITA PP 36	BC/ST	BC	LED I 10W 1120 lm 3.000 K	⊥ IP20	CE CB EAC	ERC	DIM 2	283,00
INFINITA PP 53	BC/ST	BC	E27 2x77W E27	⊥ IP20	CE CB EAC	ERC	DIM 1	250,00
INFINITA PP 53	BC/ST	BC	LED G 19,5W 2850 lm 3.000 K	⊥ IP20	CE CB EAC	ERC	DIM 3	370,00
INFINITA PP 53	BC/ST	BC	LED J 10W 1120 lm 3.000 K	⊥ IP20	CE CB EAC	ERC	DIM 2	350,00

finitura vetro / glass finish

finitura struttura / frame finish

JO

design Pio e Tito Toso 2011

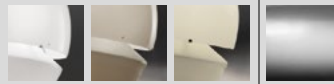

BC

FU/DI

SB

CR

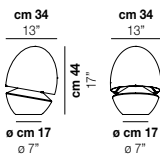

JO LT

codice / code	vetro / glass	struttura / frame	elettrificazione / lamping	CL. IP	EU cert.	International cert.	dimmer	€
JOLT	BC/DI FU/DI SB/DI	CR	E27 1x77W E27	⊥ IP20	CE CB EAC	ERC	DIM 4A	400,00

JUBE

design Favaretto&Partners 2017

finitura vetro / glass finish | finitura struttura / frame finish



CR CR/BC FU/BC FU/TR TB TB/BC VA VA/BC OS

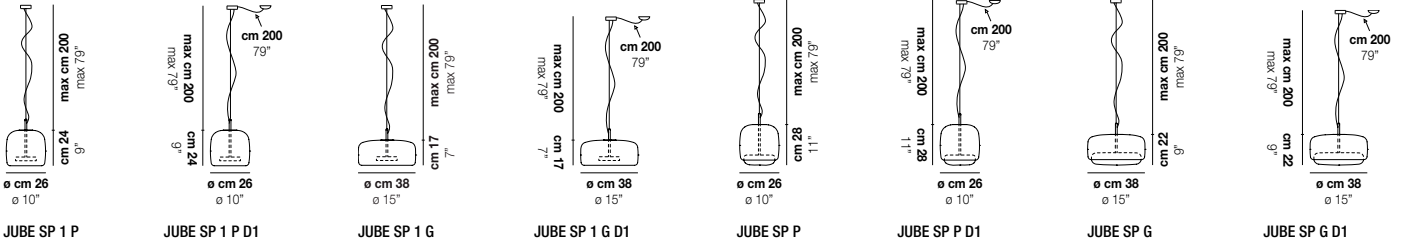

codice / code	vetro / glass	struttura / frame	elettrificazione / lamping	CL. IP	EU cert.	International cert.	dimmer	€
JUBESP1P	CR TB VA FU/TR	OS	LED 19,5W 2850 lm	⏚ IP20	CE CB ENEC	ERC cULus PS	DIM 3	480,00
JUBESP1PD1	CR TB VA FU/TR	OS	LED 19,5W 2850 lm	⏚ IP20	CE CB ENEC	ERC cULus PS	DIM 3	510,00
JUBESP1G	CR TB VA FU/TR	OS	LED 19,5W 2850 lm	⏚ IP20	CE CB ENEC	ERC cULus PS	DIM 3	580,00
JUBESP1GD1	CR TB VA FU/TR	OS	LED 19,5W 2850 lm	⏚ IP20	CE CB ENEC	ERC cULus PS	DIM 3	620,00
JUBESP P	FU/BC TB/BC VA/BC	OS	LED 19,5W 2850 lm	⏚ IP20	CE CB ENEC	ERC cULus PS	DIM 3	580,00
JUBESP PD1	FU/BC CR/BC TB/BC VA/BC	OS	LED 19,5W 2850 lm	⏚ IP20	CE CB ENEC	ERC cULus PS	DIM 3	580,00
JUBESPG	FU/BC CR/BC TB/BC VA/BC	OS	LED 19,5W 2850 lm	⏚ IP20	CE CB ENEC	ERC cULus PS	DIM 3	680,00
JUBESPG D1	FU/BC CR/BC TB/BC VA/BC	OS	LED 19,5W 2850 lm	⏚ IP20	CE CB ENEC	ERC cULus PS	DIM 3	700,00

KIRA

design Alberto Saggia e Valerio Sommella 2017

finitura vetro / glass finish | finitura struttura / frame finish

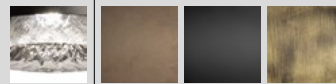

CR/BT BV NEO OT

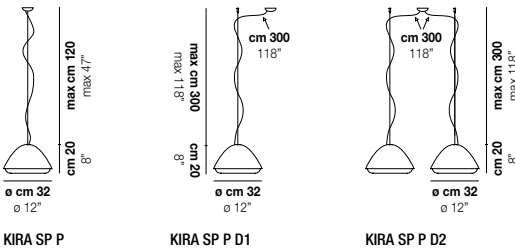

codice / code	vetro / glass	struttura / frame	elettrificazione / lamping	CL. IP	EU cert.	International cert.	dimmer	€
KIRASPP	CR/BT	BV NEO OT	E27 1x77W E27	⏚ IP20	CE CB ENEC	ERC cULus CC PS	DIM 1	355,00
KIRASPP	CR/BT	NEO	LED C 5W 600 lm 2.700 K	⏚ IP20	CE CB ENEC	ERC cULus	DIM 3	455,00
KIRASPPD1	CR/BT	BV NEO OT	E27 1x77W E27	⏚ IP20	CE CB ENEC	ERC cULus CC	DIM 1	375,00
KIRASPPD1	CR/BT	NEO	LED C 5W 600 lm 2.700 K	⏚ IP20	CE CB ENEC	ERC cULus	DIM 3	475,00
KIRASPPD	CR/BT	BV NEO OT	E27 2x77W E27	⏚ IP20	CE CB ENEC	ERC cULus CC	DIM 1	730,00

finitura vetro / glass finish | finitura struttura / frame finish

LACRIMA

design Paolo Crepax 2003



BC/LU

NI

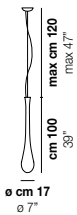

LACRIMA SP P

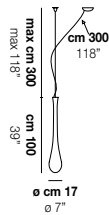

LACRIMA SP P D1

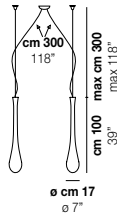

LACRIMA SP P D2

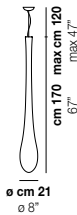

LACRIMA SP G

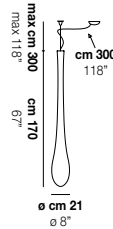

LACRIMA SP G D1

codice / code	vetro / glass	struttura / frame	elettrificazione / lamping	CL. IP	EU cert.	International cert.	dimmer	€
LACRIMASPP	BC/LU	NI	E27 1x100W E27	IP20	CE	ERAC	DIM 1	295,00
LACRIMASPP	BC/LU	NI	LED C 5W 600 lm 2.700 K	IP20	CE CB	ERAC	DIM 3	405,00
LACRIMASPPD1	BC/LU	NI	E27 1x100W E27	IP20	CE	ERAC	DIM 1	315,00
LACRIMASPPD1	BC/LU	NI	LED C 5W 600 lm 2.700 K	IP20	CE CB	ERAC	DIM 3	425,00
LACRIMASPPD2	BC/LU	NI	E27 2x100W E27	IP20	CE	ERAC	DIM 1	620,00
LACRIMASPG	BC/LU	NI	E27 1x100W E27	IP20	CE	ERAC	DIM 1	570,00
LACRIMASPG	BC/LU	NI	LED C 5W 600 lm 2.700 K	IP20	CE CB	ERAC	DIM 3	670,00
LACRIMASPGD1	BC/LU	NI	E27 1x100W E27	IP20	CE	ERAC	DIM 1	590,00
LACRIMASPGD1	BC/LU	NI	LED C 5W 600 lm 2.700 K	IP20	CE CB	ERAC	DIM 3	700,00

finitura vetro / glass finish | finitura struttura / frame finish

LEPANTO

design Luciano Vistosi 1968



BC/PU

NI

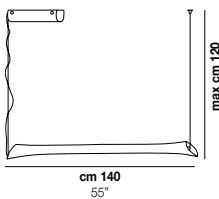

LEPANTO SP FL

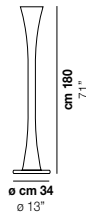

LEPANTO PT

codice / code	vetro / glass	struttura / frame	elettrificazione / lamping	CL. IP	EU cert.	International cert.	dimmer	€
LEPANTOSPFL	BC/PU	NI	G5 1x54W G5	IP20	CE	ERAC		960,00
LEPANTOPT	BC/PU	NI	G5 1x35W G5 + 1x205W E27	IP20	CE	ERAC		1.800,00

LIO

archivio storico Vetreria Vistosi 1972

finitura vetro / glass finish | finitura struttura / frame finish

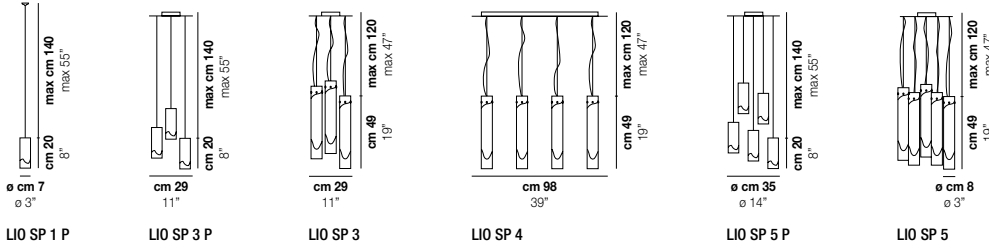

codice / code	vetro / glass	struttura / frame	elettrificazione / lamping	CL. IP	EU cert.	International cert.	dimmer	€
LIO SP 1 P	CR/BC	NI	G9 1x60W G9	IP20	CE CB EAC		DIM 1	152,00
LIO SP 1 P	CR/BC	NI	LED A 5W 600 lm 2.700 K	IP20	CE CB EAC		DIM 3	302,00
LIO SP 3 P	CR/BC	NI	G9 3x60W G9	IP20	CE CB EAC		DIM 1	590,00
LIO SP 3	CR/BC	NI	E27 3x100W E27	IP20	CE CB EAC		DIM 1	800,00
LIO SP 4	CR/BC	NI	E27 4x100W E27	IP20	CE CB EAC		DIM 1	1.100,00
LIO SP 5 P	CR/BC	NI	G9 1x60W G9	IP20	CE CB EAC		DIM 1	920,00
LIO SP 5	CR/BC	NI	E27 5x100W E27	IP20	CE CB EAC		DIM 1	1.350,00

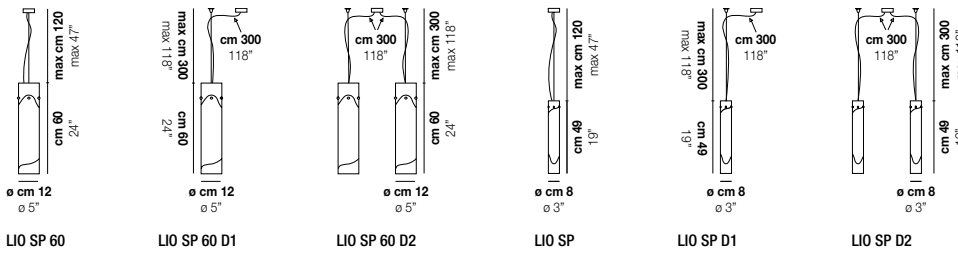

codice / code	vetro / glass	struttura / frame	elettrificazione / lamping	CL. IP	EU cert.	International cert.	dimmer	€
LIO SP 60	CR/BC	NI	E27 1x77W E27	IP20	CE CB EAC		DIM 1	400,00
LIO SP 60	CR/BC	NI	LED C 5W 600 lm 2.700 K	IP20	CE CB EAC		DIM 3	500,00
LIO SP 60 D1	CR/BC	NI	E27 1x77W E27	IP20	CE CB EAC		DIM 1	435,00
LIO SP 60 D1	CR/BC	NI	LED C 5W 600 lm 2.700 K	IP20	CE CB EAC		DIM 3	535,00
LIO SP 60 D2	CR/BC	NI	E27 2x77W E27	IP20	CE CB EAC		DIM 1	840,00
LIO SP	CR/BC	NI	E27 1x100W E27	IP20	CE CB EAC		DIM 1	270,00
LIO SP	CR/BC	NI	LED C 5W 600 lm 2.700 K	IP20	CE CB EAC		DIM 3	370,00
LIO SP D1	CR/BC	NI	E27 1x100W E27	IP20	CE CB EAC		DIM 1	300,00
LIO SP D1	CR/BC	NI	LED C 5W 600 lm 2.700 K	IP20	CE CB EAC		DIM 3	400,00
LIO SP D2	CR/BC	NI	E27 2x100W E27	IP20	CE CB EAC		DIM 1	570,00

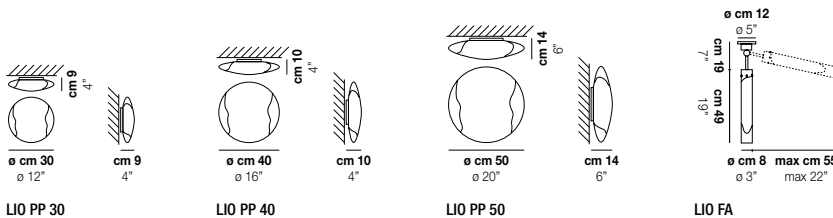

codice / code	vetro / glass	struttura / frame	elettrificazione / lamping	CL. IP	EU cert.	International cert.	dimmer	€
LIO PP 30	CR/BC	BC	E27 1x77W E27	IP20	CE CB EAC		DIM 1	178,00

codice / code	vetro / glass	struttura / frame	elettrificazione / lamping	CL. IP	EU cert.	International cert.	dimmer	€
LIOPP30	CR/BC	BC	LED F 12,5W 1650 lm 3.000 K	⊥ IP20	CE CB EAC	ERC	DIM 3	278,00
LIOPP30	CR/BC	BC	LED I 10W 1120 lm 3.000 K	⊥ IP20	CE CB EAC	ERC	DIM 2	263,00
LIOPP40	CR/BC	BC	E27 1x77W E27	⊥ IP20	CE CB EAC	ERC	DIM 1	235,00
LIOPP40	CR/BC	BC	LED F 12,5W 1650 lm 3.000 K	⊥ IP20	CE CB EAC	ERC	DIM 3	335,00
LIOPP40	CR/BC	BC	LED I 10W 1120 lm 3.000 K	⊥ IP20	CE CB EAC	ERC	DIM 2	320,00
LIOPP50	CR/BC	BC	E27 2x77W E27	⊥ IP20	CE CB EAC	ERC	DIM 1	310,00
LIOPP50	CR/BC	BC	LED G 19,5W 2850 lm 3.000 K	⊥ IP20	CE CB EAC	ERC	DIM 3	430,00
LIOPP50	CR/BC	BC	LED J 10W 1120 lm 3.000 K	⊥ IP20	CE CB EAC	ERC	DIM 2	410,00
LI OFA	CR/BC	NI	E27 1x100W E27	⊥ IP20	CE CB EAC	ERC	DIM 1	285,00

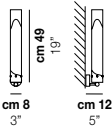

LIO AP 48

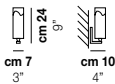

LIO AP L1 P

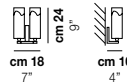

LIO AP L2 P



LIO LT 40

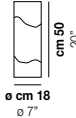

LIO LT 50



LIO LT P

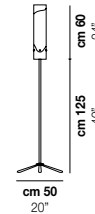

LIO PT

codice / code	vetro / glass	struttura / frame	elettrificazione / lamping	CL. IP	EU cert.	International cert.	dimmer	€
LIO AP 48	CR/BC	NI	E27 1x77W E27	⊥ IP20	CE	ERC	DIM 1	275,00
LIO AP L1 P	CR/BC	NI	G9 1x60W G9	⊥ IP20	CE	ERC	DIM 1	260,00
LIO AP L2 P	CR/BC	NI	G9 2x60W G9	⊥ IP20	CE	ERC	DIM 1	370,00
LIO LT 40	CR/BC		E27 1x77W E27	⊥ IP20	CE	ERC	DIM 4A	290,00
LIO LT 50	CR/BC		E27 1x77W E27	⊥ IP20	CE	ERC	DIM 4A	365,00
LIO LT P	CR/BC	NI	G9 1x60W G9	⊥ IP20	CE	ERC	DIM 4A	210,00
LIO PT	CR/BC	NI	E27 1x205W E27	⊥ IP20	CE	ERC		1.010,00

finitura vetro / glass finish | finitura struttura / frame finish

LUCCIOLA

archivio storico Vetreria Vistosi 1981



BC/ST



BC



NI



LUCCIOLA SP 18

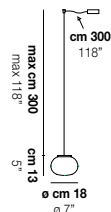

LUCCIOLA SP 18 D1

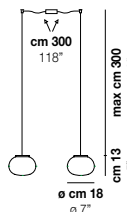

LUCCIOLA SP 18 D2

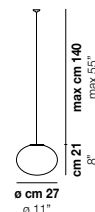

LUCCIOLA SP 27

codice / code	vetro / glass	struttura / frame	elettrificazione / lamping	CL. IP	EU cert.	International cert.	dimmer	€
LUCCIOLASP18	BC/ST	BC	E14 1x46W E14	⊥ IP20	CE CB EAC	ERC	DIM 1	90,00
LUCCIOLASP18	BC/ST	BC	LED E 6W 825 lm 3.000 K	⊥ IP20	CE CB EAC	ERC	DIM 3	215,00
LUCCIOLASP18D1	BC/ST	BC	E14 1x46W E14	⊥ IP20	CE CB EAC	ERC	DIM 1	110,00
LUCCIOLASP18D1	BC/ST	BC	LED E 6W 825 lm 3.000 K	⊥ IP20	CE CB EAC	ERC	DIM 3	235,00
LUCCIOLASP18D2	BC/ST	BC	E14 2x46W E14	⊥ IP20	CE CB EAC	ERC	DIM 1	178,00
LUCCIOLASP27	BC/ST	BC	E14 1x46W E14	⊥ IP20	CE CB EAC	ERC	DIM 1	116,00
LUCCIOLASP27	BC/ST	BC	LED E 6W 825 lm 3.000 K	⊥ IP20	CE CB EAC	ERC	DIM 3	241,00

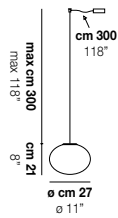

LUCCIOLA SP 27 D1

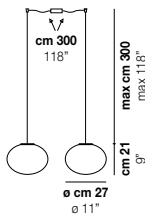

LUCCIOLA SP 27 D2

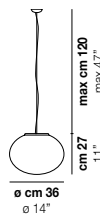

LUCCIOLA SP P

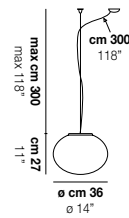

LUCCIOLA SP P D1

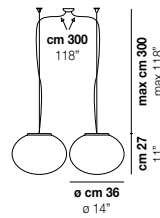

LUCCIOLA SP P D2

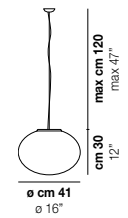

LUCCIOLA SP M

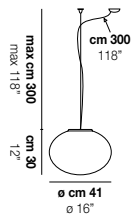

LUCCIOLA SP M D1

codice / code	vetro / glass	struttura / frame	elettrificazione / lamping	CL. IP	EU cert.	International cert.	dimmer	€
LUCCIOLASP27D1	BC/ST	BC	E14 1x46W E14	⊥ IP20	CE CB EAC		DIM 1	136,00
LUCCIOLASP27D1	BC/ST	BC	LED E 6W 825 lm 3.000 K	⊥ IP20	CE CB EAC		DIM 3	261,00
LUCCIOLASP27D2	BC/ST	BC	E14 2x46W E14	⊥ IP20	CE CB EAC		DIM 1	250,00
LUCCIOLASP	BC/ST	NI	E27 1x77W E27	⊥ IP20	CE CB EAC		DIM 1	195,00
LUCCIOLASP	BC/ST	NI	LED F 12,5W 1650 lm 3.000 K	⊥ IP20	CE CB EAC		DIM 3	300,00
LUCCIOLASP	BC/ST	NI	LED I 10W 1120 lm 3.000 K	⊥ IP20	CE CB EAC		DIM 2	280,00
LUCCIOLASPPD1	BC/ST	NI	E27 1x77W E27	⊥ IP20	CE CB EAC		DIM 1	220,00
LUCCIOLASPPD1	BC/ST	NI	LED F 12,5W 1650 lm 3.000 K	⊥ IP20	CE CB EAC		DIM 3	325,00
LUCCIOLASPPD1	BC/ST	NI	LED I 10W 1120 lm 3.000 K	⊥ IP20	CE CB EAC		DIM 2	305,00
LUCCIOLASPPD2	BC/ST	NI	E27 2x77W E27	⊥ IP20	CE CB EAC		DIM 1	420,00
LUCCIOLASPM	BC/ST	NI	E27 1x77W E27	⊥ IP20	CE CB EAC		DIM 1	230,00
LUCCIOLASPM	BC/ST	NI	E27 3x77W E27	⊥ IP20	CE CB EAC		DIM 1	260,00
LUCCIOLASPM	BC/ST	NI	LED F 12,5W 1650 lm 3.000 K	⊥ IP20	CE CB EAC		DIM 3	335,00
LUCCIOLASPM	BC/ST	NI	LED I 10W 1120 lm 3.000 K	⊥ IP20	CE CB EAC		DIM 2	315,00
LUCCIOLASPM D1	BC/ST	NI	E27 1x77W E27	⊥ IP20	CE CB EAC		DIM 1	250,00
LUCCIOLASPM D1	BC/ST	NI	E27 3x77W E27	⊥ IP20	CE CB EAC		DIM 1	285,00
LUCCIOLASPM D1	BC/ST	NI	LED F 12,5W 1650 lm 3.000 K	⊥ IP20	CE CB EAC		DIM 3	355,00
LUCCIOLASPM D1	BC/ST	NI	LED I 10W 1120 lm 3.000 K	⊥ IP20	CE CB EAC		DIM 2	335,00

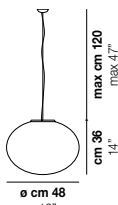

LUCCIOLA SP G

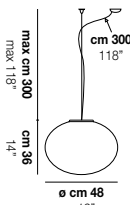

LUCCIOLA SP G D1

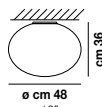

LUCCIOLA PL G

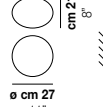

LUCCIOLA PP 27

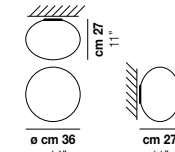

LUCCIOLA PP P

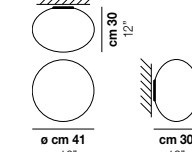

LUCCIOLA PP M

codice / code	vetro / glass	struttura / frame	elettrificazione / lamping	CL. IP	EU cert.	International cert.	dimmer	€
LUCCIOLASPG	BC/ST	NI	E27 1x77W E27	⊥ IP20	CE CB EAC		DIM 1	295,00
LUCCIOLASPG	BC/ST	NI	E27 3x77W E27	⊥ IP20	CE CB EAC		DIM 1	320,00
LUCCIOLASPG	BC/ST	NI	LED F 12,5W 1650 lm 3.000 K	⊥ IP20	CE CB EAC		DIM 3	400,00
LUCCIOLASPG	BC/ST	NI	LED I 10W 1120 lm 3.000 K	⊥ IP20	CE CB EAC		DIM 2	380,00
LUCCIOLASPGD1	BC/ST	NI	E27 1x77W E27	⊥ IP20	CE CB EAC		DIM 1	315,00
LUCCIOLASPGD1	BC/ST	NI	E27 3x77W E27	⊥ IP20	CE CB EAC		DIM 1	340,00
LUCCIOLASPGD1	BC/ST	NI	LED F 12,5W 1650 lm 3.000 K	⊥ IP20	CE CB EAC		DIM 3	420,00
LUCCIOLASPGD1	BC/ST	NI	LED I 10W 1120 lm 3.000 K	⊥ IP20	CE CB EAC		DIM 2	400,00
LUCCIOLAPLG	BC/ST	BC	E27 3x77W E27	⊥ IP20	CE CB EAC		DIM 1	280,00
LUCCIOLAPLG	BC/ST	BC	LED F 12,5W 1650 lm 3.000 K	⊥ IP20	CE CB EAC		DIM 3	380,00
LUCCIOLAPLG	BC/ST	BC	LED I 10W 1120 lm 3.000 K	⊥ IP20	CE CB EAC		DIM 2	365,00
LUCCIOLAPP27	BC/ST	BC	E14 1x48W E14	⊥ IP20	CE CB EAC		DIM 1	100,00
LUCCIOLAPP27	BC/ST	BC	LED E 6W 825 lm 3.000 K	⊥ IP20	CE CB EAC		DIM 3	215,00
LUCCIOLAPP	BC/ST	BC	LED F 12,5W 1650 lm 3.000 K	⊥ IP20	CE CB EAC		DIM 3	244,00
LUCCIOLAPP	BC/ST	BC	LED I 10W 1120 lm 3.000 K	⊥ IP20	CE CB EAC		DIM 2	229,00
LUCCIOLAPP	BC/ST	BC	E27 3x77W E27	⊥ IP20	CE CB EAC		DIM 1	172,00

codice / code	vetro / glass	struttura / frame	elettrificazione / lamping	CL. IP	EU cert.	International cert.	dimmer	€
LUCCIOLA PPM	BC/ST	BC	LED F 12,5W 1650 lm 3.000 K	⊥ IP20	CE CB	ERAC	DIM 3	272,00
LUCCIOLA PPM	BC/ST	BC	LED I 10W 1120 lm 3.000 K	⊥ IP20	CE CB	ERAC	DIM 2	257,00

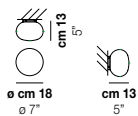

LUCCIOLA FA 18



LUCCIOLA LT 18



LUCCIOLA LT 27



LUCCIOLA LT P

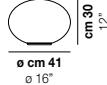

LUCCIOLA LT M

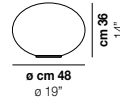

LUCCIOLA LT G

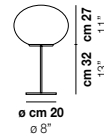

LUCCIOLA LT 30 P

codice / code	vetro / glass	struttura / frame	elettrificazione / lamping	CL. IP	EU cert.	International cert.	dimmer	€
LUCCIOLA FA 18	BC/ST	BC	E14 1x48W E14	⊥ IP20	CE CB	ERAC	DIM 1	74,00
LUCCIOLA FA 18	BC/ST	BC	LED E 6W 825 lm 3.000 K	⊥ IP20	CE CB	ERAC	DIM 3	189,00
LUCCIOLA LT 18	BC/ST	BC	E14 1x48W E14	□ IP20	CE	ERAC	DIM 4A	90,00
LUCCIOLA LT 27	BC/ST	BC	E14 1x48W E14	□ IP20	CE	ERAC	DIM 4A	116,00
LUCCIOLA LT 30 P	BC/ST	NI	E27 1x77W E27	□ IP20	CE CB	ERAC	DIM 4A	360,00
LUCCIOLA LTP	BC/ST	NI	E27 1x77W E27	□ IP20	CE CB	ERAC	DIM 4A	185,00
LUCCIOLA LTM	BC/ST	NI	E27 1x77W E27	□ IP20	CE CB	ERAC	DIM 4A	210,00
LUCCIOLA LTG	BC/ST	NI	E27 1x77W E27	□ IP20	CE CB	ERAC	DIM 4A	295,00

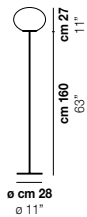

LUCCIOLA PT P

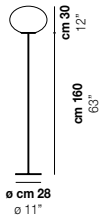

LUCCIOLA PT M

codice / code	vetro / glass	struttura / frame	elettrificazione / lamping	CL. IP	EU cert.	International cert.	dimmer	€
LUCCIOLA PTP	BC/ST	NI	E27 1x205W E27	⊥ IP20	CE	ERAC		485,00
LUCCIOLA PTM	BC/ST	NI	E27 1x205W E27	⊥ IP20	CE	ERAC		540,00

finitura vetro / glass finish finitura struttura / frame finish

MENDELEEV

design Andrea Boschetti_Metrogramma 2017



BC/SF



NN

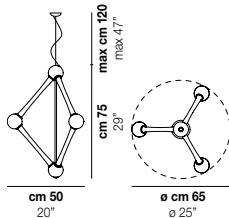

MENDELEEV SP

codice / code	vetro / glass	struttura / frame	elettrificazione / lamping	CL. IP	EU cert.	International cert.	dimmer	€
MENDELEEV SP	BC/SF	NN	LED 2W 1050 lm	⊥ IP20	CE	ERAC		2.290,00

MIA

studio tecnico Vetreria Vistosi 2013

finitura vetro / glass finish | finitura struttura / frame finish



BC/ST

BC

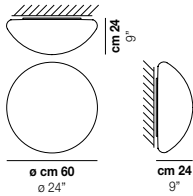

MIA PP 60

codice / code	vetro / glass	struttura / frame	elettrificazione / lamping	CL. IP	EU cert.	International cert.	dimmer	€
MIAPP60	BC/ST	BC	E27 3x77W E27	⊥ IP20	CE CB ENEC	ERAC	DIM 1	355,00
MIAPP60	BC/ST	BC	LED N 10W 1120 lm 3.000 K	⊥ IP20	CE CB ENEC	ERAC	DIM 2	455,00
MIAPP60	BC/ST	BC	LED O 19,5W 2850 lm 3.000 K	⊥ IP20	CE CB ENEC	ERAC	DIM 3	495,00

MIRAGE

design Giovanni Barbato 2017

finitura vetro / glass finish | finitura struttura / frame finish



BC/AM

BC/CR

BC/FU

BC

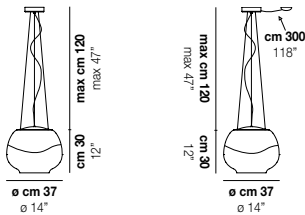

MIRAGE SP

MIRAGE SP D1

codice / code	vetro / glass	struttura / frame	elettrificazione / lamping	CL. IP	EU cert.	International cert.	dimmer	€
MIRAGESP	BC/AM BC/FU	BC	LED 19,5W 2850 lm	⊥ IP20	CE CB ENEC	ERAC	DIM 3	660,00
MIRAGESP	BC/CR	BC	LED 19,5W 2850 lm	⊥ IP20	CE CB ENEC	ERAC	DIM 3	620,00
MIRAGESPD1	BC/AM BC/FU	BC	LED 19,5W 2850 lm	⊥ IP20	CE CB ENEC	ERAC	DIM 3	680,00
MIRAGESPD1	BC/CR	BC	LED 19,5W 2850 lm	⊥ IP20	CE CB ENEC	ERAC	DIM 3	640,00

MORIS

studio tecnico Vetreria Vistosi 1998

finitura vetro / glass finish | finitura struttura / frame finish



BC/ST

BC

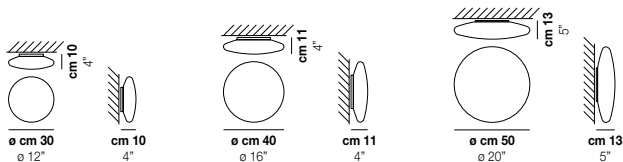

MORIS PP 30

MORIS PP 40

MORIS PP 50

codice / code	vetro / glass	struttura / frame	elettrificazione / lamping	CL. IP	EU cert.	International cert.	dimmer	€
MORISPP30	BC/ST	BC	E27 1x77W E27	⊥ IP20	CE CB ENEC	ERAC	DIM 1	82,00
MORISPP30	BC/ST	BC	LED F 12,5W 1650 lm 3.000 K	⊥ IP20	CE CB ENEC	ERAC	DIM 3	182,00
MORISPP30	BC/ST	BC	LED I 10W 1120 lm 3.000 K	⊥ IP20	CE CB ENEC	ERAC	DIM 2	167,00

codice / code	vetro / glass	struttura / frame	elettrificazione / lamping	CL. IP	EU cert.	International cert.	dimmer	€
MORISPP 40	BC/ST	BC	E27 1×77W E27	⊥ IP20	CE	CB EAC	DIM 1	130,00
MORISPP 40	BC/ST	BC	LED G 19,5W 2850 lm 3.000 K	⊥ IP20	CE	CB EAC	DIM 3	250,00
MORISPP 40	BC/ST	BC	LED J 10W 1120 lm 3.000 K	⊥ IP20	CE	CB EAC	DIM 2	230,00
MORISPP 50	BC/ST	BC	E27 2×77W E27	⊥ IP20	CE	CB EAC	DIM 1	210,00
MORISPP 50	BC/ST	BC	LED G 19,5W 2850 lm 3.000 K	⊥ IP20	CE	CB EAC	DIM 3	330,00
MORISPP 50	BC/ST	BC	LED J 10W 1120 lm 3.000 K	⊥ IP20	CE	CB EAC	DIM 2	310,00

finitura vetro / glass finish | finitura struttura / frame finish

MUNEGA

design Luciano Vistosi 1978

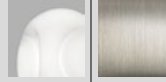

BC | NI

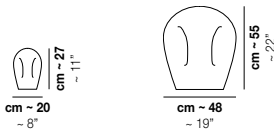

MUNEGA LT P

MUNEGA LT G

codice / code	vetro / glass	struttura / frame	elettrificazione / lamping	CL. IP	EU cert.	International cert.	dimmer	€
MUNEGALTP	BC		E14 1×60W E14	☐ IP20	CE	EAC	DIM 4A	235,00
MUNEGALTG	BC		E27 1×77W E27	☐ IP20	CE	EAC	DIM 4A	550,00

finitura vetro / glass finish | finitura struttura / frame finish



SE | CR

NARANZA

archivio storico Vetreteria Vistosi 1965 - restyling 2007

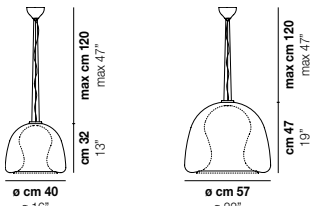

NARANZA SP P

NARANZA SP G

codice / code	vetro / glass	struttura / frame	elettrificazione / lamping	CL. IP	EU cert.	International cert.	dimmer	€
NARANZASP P	SE	CR	E27 1×77W E27	⊥ IP20	CE	EAC	DIM 1	870,00
NARANZASP P	SE	CR	LED C 5W 600 lm 2.700 K	⊥ IP20	CE	CB EAC	DIM 3	970,00
NARANZASP G	SE	CR	E27 1×77W E27	⊥ IP20	CE	EAC	DIM 1	1.540,00

NAXOS

archivio storico Vetreria Vistosi 1988

finitura vetro / glass finish | finitura struttura / frame finish



BC/ST

BC

NI

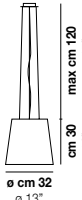

NAXOS SP 50

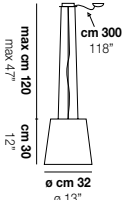

NAXOS SP 50 D1

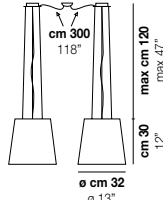

NAXOS SP 50 D2

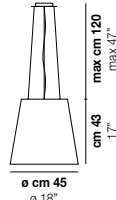

NAXOS SP 76

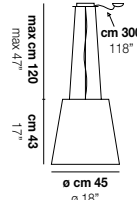

NAXOS SP 76 D1

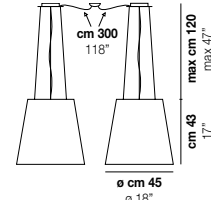

NAXOS SP 76 D2

codice / code	vetro / glass	struttura / frame	elettrificazione / lamping	CL. IP	EU cert.	International cert.	dimmer	€
NAXOS SP 50	BC/ST	NI	E27 3x77W E27	⊥ IP20	CE	EAC cULus CCC	DIM 1	275,00
NAXOS SP 50 D1	BC/ST	NI	E27 3x77W E27	⊥ IP20	CE	EAC cULus CCC	DIM 1	305,00
NAXOS SP 50 D2	BC/ST	NI	E27 6x77W E27	⊥ IP20	CE	EAC cULus CCC	DIM 1	580,00
NAXOS SP 76	BC/ST	NI	E27 3x77W E27	⊥ IP20	CE	EAC cULus CCC	DIM 1	620,00
NAXOS SP 76 D1	BC/ST	NI	E27 3x77W E27	⊥ IP20	CE	EAC cULus CCC	DIM 1	650,00
NAXOS SP 76 D2	BC/ST	NI	E27 6x77W E27	⊥ IP20	CE	EAC cULus CCC	DIM 1	1.260,00



NAXOS LT 33

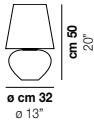

NAXOS LT 50

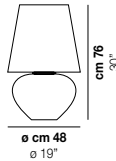

NAXOS LT 76



NAXOS LT MN

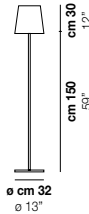

NAXOS PT 50

codice / code	vetro / glass	struttura / frame	elettrificazione / lamping	CL. IP	EU cert.	International cert.	dimmer	€
NAXOSLT33	BC/ST	BC	E14 1x60W E14 + 1x40W E14	⊥ IP20	CE	EAC cULus CCC	DIM 4A	250,00
NAXOSLT50	BC/ST	BC	E27 1x77W E27 + 1x40W E14	⊥ IP20	CE	EAC cULus CCC	DIM 4A	260,00
NAXOSLT76	BC/ST	BC	E27 1x77W E27 + 3x60W E14 + 1x46W E27	⊥ IP20	CE	EAC cULus CCC	DIM 4A	680,00
NAXOSLTMN	BC/ST	BC	E14 1x60W E14	⊥ IP20	CE	EAC cULus CCC	DIM 4A	168,00
NAXOSPT50	BC/ST	NI	E27 3x77W E27	⊥ IP20	CE	EAC cULus CCC		710,00

finitura vetro / glass finish | finitura struttura / frame finish

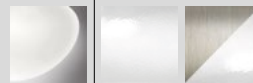

BC/ST

BC

NIB

NEOCHIC

design Chiamonte & Marin 2013

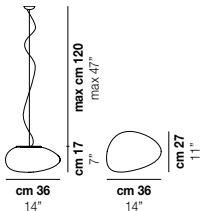

NEOCHIC SP P

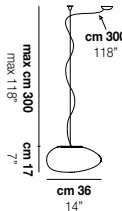

NEOCHIC SP P D1

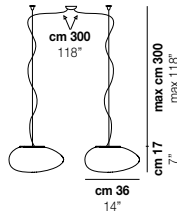

NEOCHIC SP P D2

codice / code	vetro / glass	struttura / frame	elettrificazione / lamping	CL. IP	EU cert.	International cert.	dimmer	€
NEOCHICSP P	BC/ST	NIB	E27 1x77W E27	⊥ IP20	CE CB	EAC cULus CCC	DIM 1	220,00

codice / code	vetro / glass	struttura / frame	elettrificazione / lamping	CL. IP	EU cert.	International cert.	dimmer	€
NEOCHICSP	BC/ST	NIB	LED F 12,5W 1650 lm 3.000 K	⊥ IP20	CE CB	ERC	DIM 3	325,00
NEOCHICSP	BC/ST	NIB	LED I 10W 1120 lm 3.000 K	⊥ IP20	CE CB	ERC	DIM 2	305,00
NEOCHICSP D1	BC/ST	NIB	E27 1x77W E27	⊥ IP20	CE CB	ERC	DIM 1	240,00
NEOCHICSP D1	BC/ST	NIB	LED F 12,5W 1650 lm 3.000 K	⊥ IP20	CE CB	ERC	DIM 3	345,00
NEOCHICSP D1	BC/ST	NIB	LED I 10W 1120 lm 3.000 K	⊥ IP20	CE CB	ERC	DIM 2	325,00
NEOCHICSP D2	BC/ST	NIB	E27 2x77W E27	⊥ IP20	CE CB	ERC	DIM 1	460,00

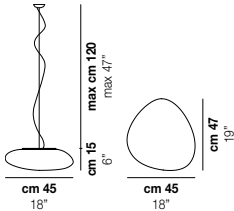

NEOCHIC SP M

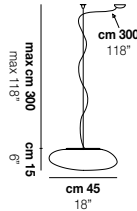

NEOCHIC SP M D1

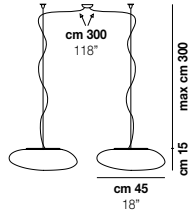

NEOCHIC SP M D2

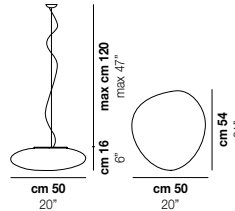

NEOCHIC SP G

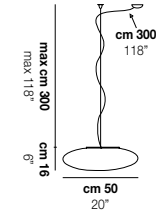

NEOCHIC SP G D1

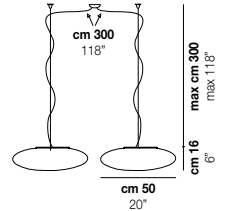

NEOCHIC SP G D2

codice / code	vetro / glass	struttura / frame	elettrificazione / lamping	CL. IP	EU cert.	International cert.	dimmer	€
NEOCHICSP M	BC/ST	NIB	E27 2x77W E27	⊥ IP20	CE CB	ERC	DIM 1	335,00
NEOCHICSP M	BC/ST	NIB	LED G 19,5W 2850 lm 3.000 K	⊥ IP20	CE CB	ERC	DIM 3	465,00
NEOCHICSP M	BC/ST	NIB	LED J 10W 1120 lm 3.000 K	⊥ IP20	CE CB	ERC	DIM 2	445,00
NEOCHICSP M D1	BC/ST	NIB	E27 2x77W E27	⊥ IP20	CE CB	ERC	DIM 1	365,00
NEOCHICSP M D1	BC/ST	NIB	LED G 19,5W 2850 lm 3.000 K	⊥ IP20	CE CB	ERC	DIM 3	495,00
NEOCHICSP M D1	BC/ST	NIB	LED J 10W 1120 lm 3.000 K	⊥ IP20	CE CB	ERC	DIM 2	475,00
NEOCHICSP M D2	BC/ST	NIB	E27 4x77W E27	⊥ IP20	CE CB	ERC	DIM 1	690,00
NEOCHICSP G	BC/ST	NIB	E27 2x77W E27	⊥ IP20	CE CB	ERC	DIM 1	375,00
NEOCHICSP G	BC/ST	NIB	LED G 19,5W 2850 lm 3.000 K	⊥ IP20	CE CB	ERC	DIM 3	505,00
NEOCHICSP G	BC/ST	NIB	LED J 10W 1120 lm 3.000 K	⊥ IP20	CE CB	ERC	DIM 2	485,00
NEOCHICSP G D1	BC/ST	NIB	E27 2x77W E27	⊥ IP20	CE CB	ERC	DIM 1	400,00
NEOCHICSP G D1	BC/ST	NIB	LED G 19,5W 2850 lm 3.000 K	⊥ IP20	CE CB	ERC	DIM 3	530,00
NEOCHICSP G D1	BC/ST	NIB	LED J 10W 1120 lm 3.000 K	⊥ IP20	CE CB	ERC	DIM 2	510,00
NEOCHICSP G D2	BC/ST	NIB	E27 4x77W E27	⊥ IP20	CE CB	ERC	DIM 1	770,00

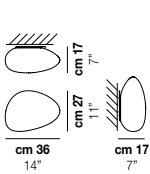

NEOCHIC PP P

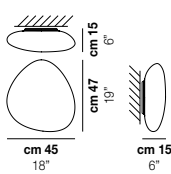

NEOCHIC PP M

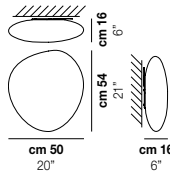

NEOCHIC PP G

codice / code	vetro / glass	struttura / frame	elettrificazione / lamping	CL. IP	EU cert.	International cert.	dimmer	€
NEOCHICPPP	BC/ST	BC	E27 1x77W E27	⊥ IP20	CE CB	ERC	DIM 1	152,00
NEOCHICPPP	BC/ST	BC	LED F 12,5W 1650 lm 3.000 K	⊥ IP20	CE CB	ERC	DIM 3	252,00
NEOCHICPPP	BC/ST	BC	LED I 10W 1120 lm 3.000 K	⊥ IP20	CE CB	ERC	DIM 2	237,00
NEOCHICPPM	BC/ST	BC	E27 2x77W E27	⊥ IP20	CE CB	ERC	DIM 1	250,00
NEOCHICPPM	BC/ST	BC	LED G 19,5W 2850 lm 3.000 K	⊥ IP20	CE CB	ERC	DIM 3	370,00
NEOCHICPPM	BC/ST	BC	LED J 10W 1120 lm 3.000 K	⊥ IP20	CE CB	ERC	DIM 2	350,00
NEOCHICPPG	BC/ST	BC	E27 2x77W E27	⊥ IP20	CE CB	ERC	DIM 1	315,00
NEOCHICPPG	BC/ST	BC	LED G 19,5W 2850 lm 3.000 K	⊥ IP20	CE CB	ERC	DIM 3	435,00
NEOCHICPPG	BC/ST	BC	LED J 10W 1120 lm 3.000 K	⊥ IP20	CE CB	ERC	DIM 2	415,00

NESSA

archivio storico Vetreria Vistosi 1972

finitura vetro / glass finish | finitura struttura / frame finish



CR/BC

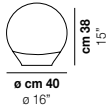

NESSA LT

codice / code	vetro / glass	struttura / frame	elettrificazione / lamping	CL. IP	EU cert.	International cert.	dimmer	€
NESSALT	CR/BC		E27 1x77W E27	IP20	CE	ERC CB PS	DIM 4A	460,00

NINFEA

design Oriano Favaretto 2009

finitura vetro / glass finish | finitura struttura / frame finish



BC

BC/LU

CR

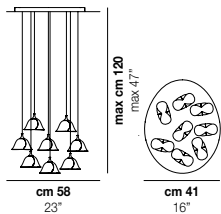

NINFEA SP 8 P

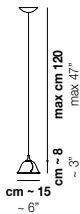

NINFEA SP P

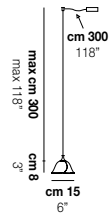

NINFEA SP P D1

codice / code	vetro / glass	struttura / frame	elettrificazione / lamping	CL. IP	EU cert.	International cert.	dimmer	€
NINFEASP8P	BCLU	CR	G9 8x60W G9	IP20	CE CB PS	ERC CB PS	DIM 1	1.980,00
NINFEASPP	BC	CR	G9 1x60W G9	IP20	CE CB PS	ERC CB PS	DIM 1	285,00
NINFEASPPD1	BC	CR	G9 1x60W G9	IP20	CE CB PS	ERC CB	DIM 1	310,00

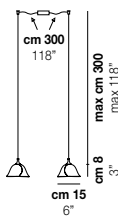

NINFEA SP P D2

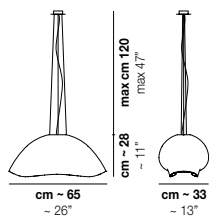

NINFEA SP G

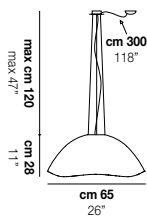

NINFEA SP G D1

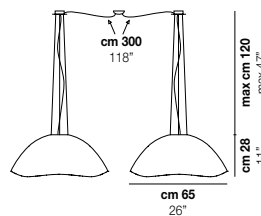

NINFEA SP G D2

codice / code	vetro / glass	struttura / frame	elettrificazione / lamping	CL. IP	EU cert.	International cert.	dimmer	€
NINFEASPPD2	BC	CR	G9 2x60W G9	IP20	CE CB PS	ERC CB	DIM 1	610,00
NINFEASPG	BCLU	CR	E27 1x77W E27	IP20	CE CB PS	ERC CB	DIM 1	780,00
NINFEASPG	BCLU	CR	LED C 5W 600 lm 2.700 K	IP20	CE CB PS	ERC CB	DIM 3	880,00
NINFEASPGD1	BCLU	CR	E27 1x77W E27	IP20	CE CB PS	ERC CB	DIM 1	810,00
NINFEASPGD1	BCLU	CR	LED C 5W 600 lm 2.700 K	IP20	CE CB PS	ERC CB	DIM 3	910,00
NINFEASPGD2	BCLU	CR	E27 2x77W E27	IP20	CE CB PS	ERC CB	DIM 1	1.600,00

finitura vetro / glass finish | finitura struttura / frame finish

NODO

design Pio e Tito Toso 2015

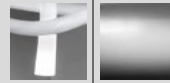

BC/LU | CR

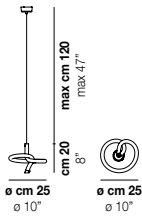

NODO SP 25

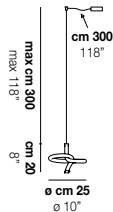

NODO SP 25 D1

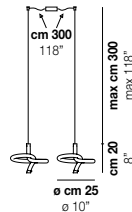

NODO SP 25 D2

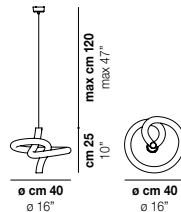

NODO SP 40

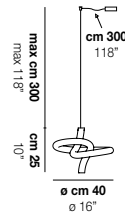

NODO SP 40 D1

codice / code	vetro / glass	struttura / frame	elettrificazione / lamping	CL. IP	EU cert.	International cert.	dimmer	€
NODO SP 25	BC/LU	CR	G9 1x48W G9	IP20	CE	ERC	DIM 1	180,00
NODO SP 25 D1	BC/LU	CR	G9 1x48W G9	IP20	CE	ERC	DIM 1	210,00
NODO SP 25 D2	BC/LU	CR	G9 2x48W G9	IP20	CE	ERC	DIM 1	400,00
NODO SP 40	BC/LU	CR	G9 1x48W G9	IP20	CE	ERC	DIM 1	285,00
NODO SP 40 D1	BC/LU	CR	G9 1x48W G9	IP20	CE	ERC	DIM 1	305,00

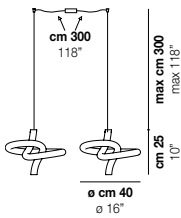

NODO SP 40 D2

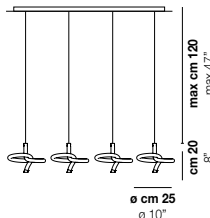

NODO SP 40 D2

codice / code	vetro / glass	struttura / frame	elettrificazione / lamping	CL. IP	EU cert.	International cert.	dimmer	€
NODO SP 40 D2	BC/LU	CR	G9 2x48W G9	IP20	CE	ERC	DIM 1	590,00
NODOSPL4	BC/LU	CR	G9 1x48W G9	IP20	CE	ERC	DIM 1	700,00

finitura vetro / glass finish | finitura struttura / frame finish

NOVECENTO

design Romani Sacconi Architetti Associati 2013



BC/RI | CR/RI | CR

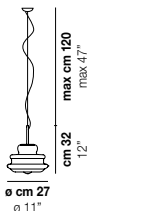

NOVECENTO SP P

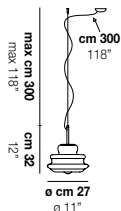

NOVECENTO SP P D1

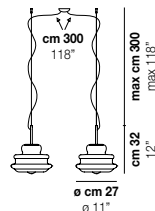

NOVECENTO SP P D2

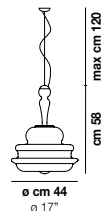

NOVECENTO SP M

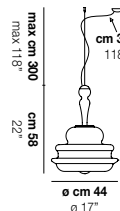

NOVECENTO SP M D1

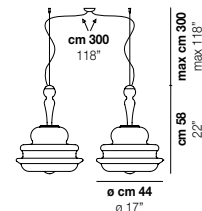

NOVECENTO SP M D2

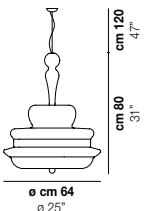

NOVECENTO SP G

codice / code	vetro / glass	struttura / frame	elettrificazione / lamping	CL. IP	EU cert.	International cert.	dimmer	€
NOVECENTOSP P	BC/RI	CR	E14 1x60W E14	IP20	CE	CB, ERC	DIM 1	275,00
NOVECENTOSP P	CR/RI	CR	E14 1x60W E14	IP20	CE	CB, ERC	DIM 1	305,00
NOVECENTOSP P D1	BC/RI	CR	E14 1x60W E14	IP20	CE	CB, ERC	DIM 1	295,00
NOVECENTOSP P D1	CR/RI	CR	E14 1x60W E14	IP20	CE	CB, ERC	DIM 1	325,00
NOVECENTOSP P D2	BC/RI	CR	E14 2x60W E14	IP20	CE	CB, ERC	DIM 1	570,00

codice / code	vetro / glass	struttura / frame	elettrificazione / lamping	CL. IP	EU cert.	International cert.	dimmer	€
NOVECENTO SP PD2	CR/RI	CR	E14 2×60W E14	⊥ IP20	CE	CB certificata EAC c.ULUS CCC	DIM 1	630,00
NOVECENTO SP M	BC/RI	CR	E27 1×77W E27	⊥ IP20	CE	CB certificata EAC c.ULUS CCC	DIM 1	510,00
NOVECENTO SP M	CR/RI	CR	E27 1×77W E27	⊥ IP20	CE	CB certificata EAC c.ULUS CCC	DIM 1	560,00
NOVECENTO SP MD1	BC/RI	CR	E27 1×77W E27	⊥ IP20	CE	CB certificata EAC c.ULUS CCC	DIM 1	540,00
NOVECENTO SP MD1	CR/RI	CR	E27 1×77W E27	⊥ IP20	CE	CB certificata EAC c.ULUS CCC	DIM 1	580,00
NOVECENTO SP MD2	BC/RI	CR	E27 2×77W E27	⊥ IP20	CE	CB certificata EAC c.ULUS CCC	DIM 1	1.040,00
NOVECENTO SP MD2	CR/RI	CR	E27 2×77W E27	⊥ IP20	CE	CB certificata EAC c.ULUS CCC	DIM 1	1.130,00
NOVECENTO SP G	BC/RI	CR	E14 5×60W E14	⊥ IP20	CE	CB certificata EAC c.ULUS CCC PS	DIM 1	1.560,00
NOVECENTO SP G	CR/RI	CR	E14 5×60W E14	⊥ IP20	CE	CB certificata EAC c.ULUS CCC PS	DIM 1	1.680,00

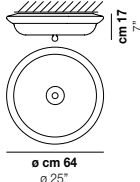

NOVECENTO PL

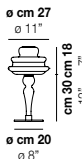

NOVECENTO LT

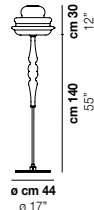

NOVECENTO PT

codice / code	vetro / glass	struttura / frame	elettrificazione / lamping	CL. IP	EU cert.	International cert.	dimmer	€
NOVECENTO PL	BC/RI CR/RI	CR	E14 5×60W E14	⊥ IP20	CE	EAC c.ULUS CCC	DIM 1	830,00
NOVECENTO LT	BC/RI	CR	E14 1×60W E14	⊥ IP20	CE	EAC c.ULUS CCC	DIM 4A	400,00
NOVECENTO LT	CR/RI	CR	E14 1×60W E14	⊥ IP20	CE	EAC c.ULUS CCC	DIM 4A	460,00
NOVECENTO PT	BC/RI	CR	E27 1×77W E27	⊥ IP20	CE	EAC c.ULUS CCC		980,00
NOVECENTO PT	CR/RI	CR	E27 1×77W E27	⊥ IP20	CE	EAC c.ULUS CCC		1.020,00

OTO

design Pio e Tito Toso 2015

finitura vetro / glass finish | finitura struttura / frame finish



BC/RI

CR/RI

AS

BC

NI

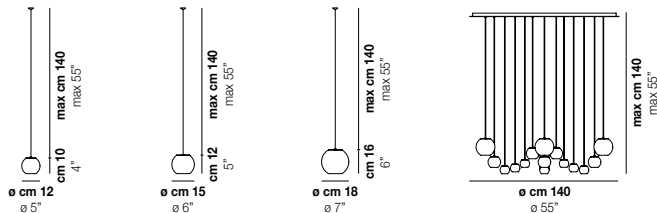

OTO SP 12

OTO SP 15

OTO SP 18

OTO SP CHA

codice / code	vetro / glass	struttura / frame	elettrificazione / lamping	CL. IP	EU cert.	International cert.	dimmer	€
OTOSP 12	AM/RI BC/RI CR/RI FU/RI	NI	G9 1×60W G9	□ IP20	CE	CB certificata EAC c.ULUS CCC	DIM 1	90,00
OTOSP 15	AM/RI BC/RI CR/RI FU/RI	NI	G9 1×60W G9	□ IP20	CE	CB certificata EAC c.ULUS CCC	DIM 1	100,00
OTOSP 18	AM/RI BC/RI CR/RI FU/RI	NI	G9 1×60W G9	□ IP20	CE	CB certificata EAC c.ULUS CCC	DIM 1	115,00
OTOSP CHA	AM/RI BC/RI CR/RI FU/RI	BC	G9 9×60W G9	⊥ IP20	CE	CB certificata EAC c.ULUS CCC	DIM 1	4.120,00
OTOSP CHA	AM/RI BC/RI CR/RI FU/RI	AS NI	G9 9×60W G9	⊥ IP20	CE	CB certificata EAC c.ULUS CCC	DIM 1	4.440,00

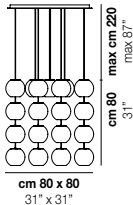

OTO SP CUB

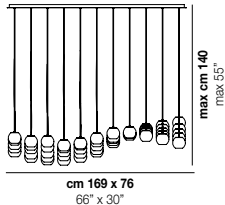

OTO SP FC

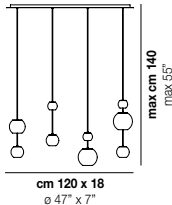

OTO SP LIN

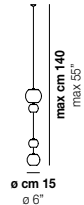

OTO SP PEA D

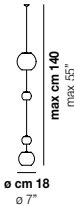

OTO SP PEA C

codice / code	vetro / glass	struttura / frame	elettrificazione / lamping	CL. IP	EU cert.	International cert.	dimmer	€
OTO SP CUB	AM/RI BC/RI CR/RI FU/RI	BC	G9 16×60W G9	⚡ IP20	CE CB	ERAC	DIM 1	5.360,00
OTO SP CUB	AM/RI BC/RI CR/RI FU/RI	AS NI	G9 16×60W G9	⚡ IP20	CE CB	ERAC	DIM 1	5.520,00
OTO SP FC	AM/RI BC/RI CR/RI FU/RI	BC	G9 12×60W G9	⚡ IP20	CE CB	ERAC	DIM 1	4.320,00
OTO SP FC	AM/RI BC/RI CR/RI FU/RI	AS NI	G9 12×60W G9	⚡ IP20	CE CB	ERAC	DIM 1	4.520,00
OTOSPLIN	AM/RI BC/RI CR/RI FU/RI	BC	G9 4×60W G9	⚡ IP20	CE CB	ERAC	DIM 1	850,00
OTOSPLIN	AM/RI BC/RI CR/RI FU/RI	AS NI	G9 4×60W G9	⚡ IP20	CE CB	ERAC	DIM 1	880,00
OTOSPPEAD	AM/RI BC/RI CR/RI FU/RI	NI	G9 1×60W G9	⚡ IP20	CE CB	ERAC	DIM 1	300,00
OTOSPPEAC	AM/RI BC/RI CR/RI FU/RI	NI	G9 1×60W G9	⚡ IP20	CE CB	ERAC	DIM 1	325,00

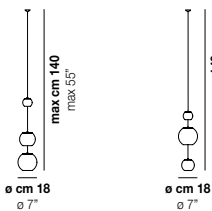

OTO SP PEA B

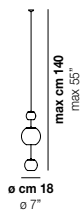

OTO SP PEA A

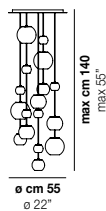

OTO SP R55

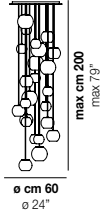

OTO SP R60

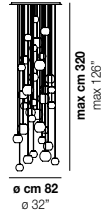

OTO SP RC

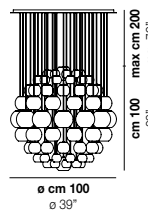

OTO SP SPH

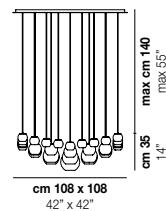

OTO SP SUR

codice / code	vetro / glass	struttura / frame	elettrificazione / lamping	CL. IP	EU cert.	International cert.	dimmer	€
OTOSPPEAB	AM/RI BC/RI CR/RI FU/RI	NI	G9 1×60W G9	⚡ IP20	CE CB	ERAC	DIM 1	270,00
OTOSPPEAA	AM/RI BC/RI CR/RI FU/RI	NI	G9 1×60W G9	⚡ IP20	CE CB	ERAC	DIM 1	345,00
OTOSPR55	AM/RI BC/RI CR/RI FU/RI	BC	G9 9×60W G9	⚡ IP20	CE CB	ERAC	DIM 1	1.540,00
OTOSPR55	AM/RI BC/RI CR/RI FU/RI	AS NI	G9 9×60W G9	⚡ IP20	CE CB	ERAC	DIM 1	1.700,00
OTOSPR60	AM/RI BC/RI CR/RI FU/RI	BC	G9 10×60W G9	⚡ IP20	CE CB	ERAC	DIM 1	2.270,00
OTOSPR60	AM/RI BC/RI CR/RI FU/RI	AS NI	G9 10×60W G9	⚡ IP20	CE CB	ERAC	DIM 1	2.430,00
OTOSPRC	AM/RI BC/RI CR/RI FU/RI	BC	G9 12×60W G9	⚡ IP20	CE CB	ERAC	DIM 1	3.350,00
OTOSPRC	AM/RI BC/RI CR/RI FU/RI	AS	G9 12×60W G9	⚡ IP20	CE CB	ERAC	DIM 1	3.750,00
OTOSPRC	AM/RI BC/RI CR/RI FU/RI	NI	G9 12×60W G9	⚡ IP20	CE CB	ERAC	DIM 1	3.950,00
OTOSPSPH	AM/RI BC/RI CR/RI FU/RI	BC	G9 13×60W G9	⚡ IP20	CE CB	ERAC	DIM 1	7.920,00
OTOSPSPH	AM/RI BC/RI CR/RI FU/RI	AS NI	G9 13×60W G9	⚡ IP20	CE CB	ERAC	DIM 1	8.130,00
OTOSPSUR	AM/RI BC/RI CR/RI FU/RI	BC	G9 17×60W G9	⚡ IP20	CE CB	ERAC	DIM 1	4.370,00
OTOSPSUR	AM/RI BC/RI CR/RI FU/RI	AS NI	G9 17×60W G9	⚡ IP20	CE CB	ERAC	DIM 1	4.630,00

finitura vetro / glass finish

OVALINA

studio tecnico Vetreria Vistosi 1993



AM/LU

AM/ST

BC/LU

BC/ST

FU/LU

FU/ST

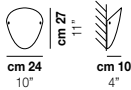

OVALINA AP

codice / code	vetro / glass	struttura / frame	elettrificazione / lamping	CL. IP	EU cert.	International cert.	dimmer	€
OVALINA AP	AM/LU AM/ST BC/LU BC/ST		E27 1x77W E27	⊥ IP20	CE CB	EAC	DIM 1	110,00
OVALINA AP	FU/LU FU/ST VA/LU VA/ST		E27 1x77W E27	⊥ IP20	CE CB	EAC	DIM 1	110,00

finitura vetro / glass finish | finitura struttura / frame finish

PEGGY

design Hangar Design Group 2014 - restyling 2017

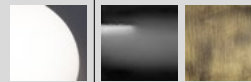

BC/LU

NEL

OT

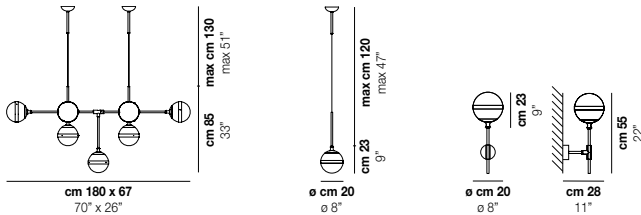

PEGGY SP 9

PEGGY SP

PEGGY AP

codice / code	vetro / glass	struttura / frame	elettrificazione / lamping	CL. IP	EU cert.	International cert.	dimmer	€
PEGGY SP 9	BC/LU	NEL	E14 9x60W E14	⊥ IP20	CE CB	EAC	DIM 1	2.600,00
PEGGY SP 9	BC/LU	OT	E14 9x60W E14	⊥ IP20	CE CB	EAC	DIM 1	2.600,00
PEGGY SP	BC/LU	OT	E14 1x60W E14	⊥ IP20	CE CB	EAC	DIM 1	280,00
PEGGY SP	BC/LU	NEL	E14 1x60W E14	⊥ IP20	CE CB	EAC	DIM 1	280,00
PEGGY AP	BC/LU	NEL OT	E14 1x60W E14	⊥ IP20	CE	EAC	DIM 1	355,00

finitura vetro / glass finish | finitura struttura / frame finish

POC

design Barbara Maggiolo 2003



CR/BC

CR/BN

NI

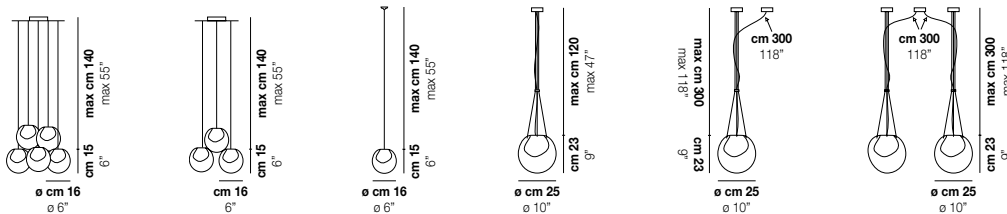

POC SP 16 5

POC SP 16 3

POC SP 16

POC SP 25

POC SP 25 D1

POC SP 25 D2

codice / code	vetro / glass	struttura / frame	elettrificazione / lamping	CL. IP	EU cert.	International cert.	dimmer	€
POC SP 16 5	CR/BC CR/BN	NI	G9 5x60W G9		CE CB	EAC	DIM 1	1.560,00
POC SP 16 3	CR/BC CR/BN	NI	G9 3x60W G9		CE CB	EAC	DIM 1	930,00
POC SP 16	CR/BC CR/BN	NI	G9 1x60W G9		CE CB	EAC	DIM 1	300,00
POC SP 16	CR/BC CR/BN	NI	LED B 5W 600 lm 2.700 K	⊥ IP20	CE CB	EAC	DIM 3	450,00

codice / code	vetro / glass	struttura / frame	elettrificazione / lamping	CL. IP	EU cert.	International cert.	dimmer	€
POC SP 25	CR/BC CR/BN	NI	G9 1x60W G9		CE	ERC	DIM 1	475,00
POC SP 25 D1	CR/BC CR/BN	NI	G9 1x60W G9		CE	ERC	DIM 1	550,00
POC SP 25 D2	CR/BC CR/BN	NI	G9 2x60W G9		CE	ERC	DIM 1	1.040,00

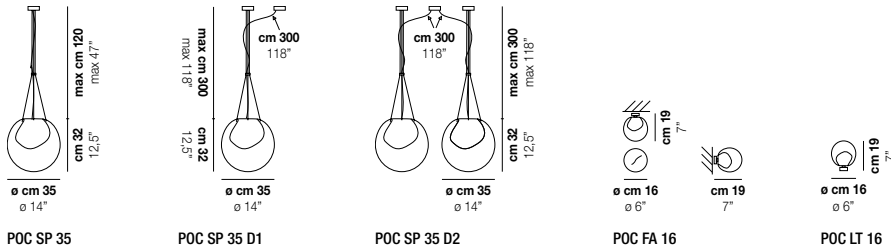

codice / code	vetro / glass	struttura / frame	elettrificazione / lamping	CL. IP	EU cert.	International cert.	dimmer	€
POC SP 35	CR/BC CR/BN	NI	G9 2x60W G9		CE	ERC	DIM 1	610,00
POC SP 35 D1	CR/BC CR/BN	NI	G9 2x60W G9		CE	ERC	DIM 1	680,00
POC SP 35 D2	CR/BC CR/BN	NI	G9 4x60W G9		CE	ERC	DIM 1	1.310,00
POC FA 16	CR/BC CR/BN	NI	G9 1x60W G9	⊥ IP20	CE	ERC	DIM 1	325,00
POC FA 16	CR/BC CR/BN	NI	LED D 5W 600 lm 2.700 K	⊥ IP20	CE	ERC	DIM 3	475,00
POCLT16	CR/BC CR/BN	NI	G9 1x60W G9					320,00

finitura vetro / glass finish | finitura struttura / frame finish

POD
design Babled & Co. 2005



BC/LU | BC

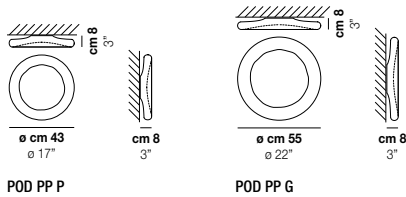

codice / code	vetro / glass	struttura / frame	elettrificazione / lamping	CL. IP	EU cert.	International cert.	dimmer	€
POD PPP	BC/LU	BC	G9 4x33W G9	⊥ IP20	CE	ERC	DIM 1	410,00
POD PPG	BC/LU	BC	G9 4x33W G9	⊥ IP20	CE	ERC	DIM 1	500,00

finitura vetro / glass finish | finitura struttura / frame finish

PUPPET

design Romani Saccani Architetti Associati 2015

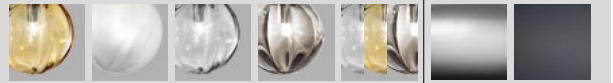

AM/TR BC/SF CR/TR FU/TR MC/1 CR NE

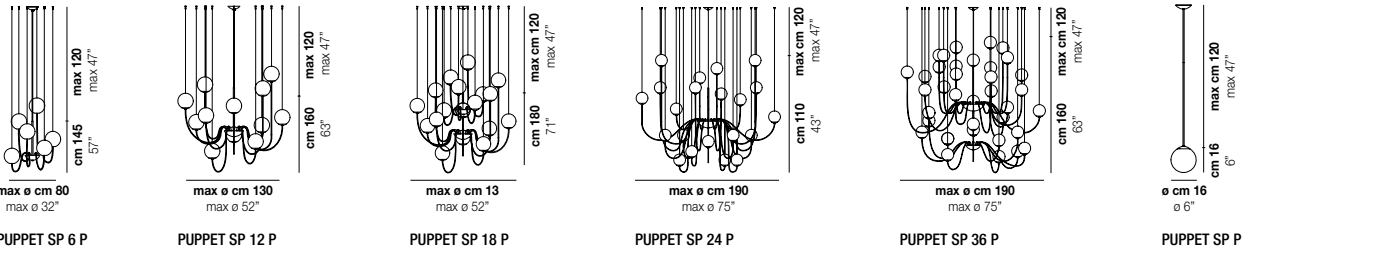

codice / code	vetro / glass	struttura / frame	elettrificazione / lamping	CL. IP	EU cert.	International cert.	dimmer	€
PUPPET SP 6 P	BC/SF CR/TR FU/TR AM/TR	CR NE	G9 6×60W G9		CE CB ENEC EAC		DIM 1	920,00
PUPPET SP 12 P	BC/SF CR/TR FU/TR AM/TR	CR NE	G9 12×60W G9		CE CB ENEC EAC		DIM 1	1.880,00
PUPPET SP 18 P	BC/SF CR/TR FU/TR AM/TR	CR NE	G9 18×60W G9		CE CB ENEC EAC		DIM 1	2.810,00
PUPPET SP 24 P	BC/SF CR/TR FU/TR AM/TR	CR NE	G9 24×60W G9		CE CB ENEC EAC		DIM 1	3.750,00
PUPPET SP 36 P	BC/SF CR/TR FU/TR AM/TR	CR NE	G9 36×40W G9		CE CB ENEC EAC		DIM 1	5.620,00
PUPPET SP P	BC/SF CR/TR FU/TR AM/TR	CR NE	G9 1×60W G9		CE CB ENEC EAC	PS	DIM 1	178,00

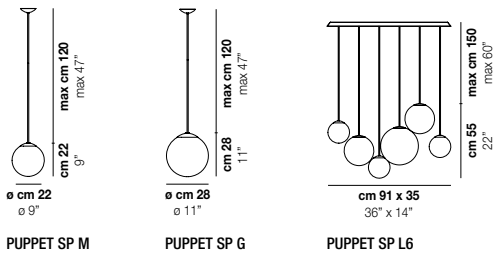

codice / code	vetro / glass	struttura / frame	elettrificazione / lamping	CL. IP	EU cert.	International cert.	dimmer	€
PUPPET SP M	BC/SF CR/TR FU/TR AM/TR	CR NE	G9 1×60W G9		CE CB ENEC EAC	PS	DIM 1	210,00
PUPPET SP G	BC/SF CR/TR FU/TR AM/TR	CR NE	G9 1×60W G9		CE CB ENEC EAC	PS	DIM 1	245,00
PUPPET SP L6	BC/SF CR/TR FU/TR AM/TR	CR NE	G9 6×60W G9		CE CB ENEC EAC		DIM 1	1.320,00

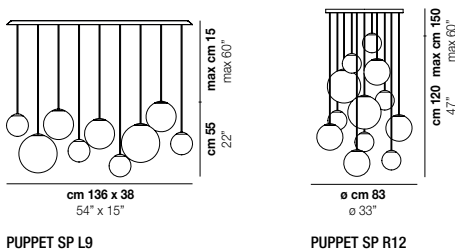

codice / code	vetro / glass	struttura / frame	elettrificazione / lamping	CL. IP	EU cert.	International cert.	dimmer	€
PUPPET SP L9	MC/1	NE	G9 9×60W G9		CE CB ENEC EAC		DIM 1	1.980,00
PUPPET SP L9	BC/SF CR/TR FU/TR AM/TR	CR NE	G9 9×60W G9		CE CB ENEC EAC		DIM 1	1.980,00
PUPPET SP R12	MC/1	CR	G9 12×60W G9		CE CB ENEC EAC		DIM 1	2.600,00
PUPPET SP R12	BC/SF CR/TR FU/TR AM/TR	CR NE	G9 12×60W G9		CE CB ENEC EAC		DIM 1	2.710,00

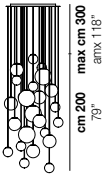

ø cm 108
ø 43"

PUPPET SP R24

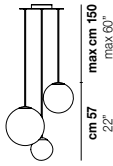

ø cm 50
ø 20"

PUPPET SP R3

codice / code	vetro / glass	struttura / frame	elettrificazione / lamping	CL. IP	EU cert.	International cert.	dimmer	€
PUPPET SP R24	BC/SF CR/TR FU/TR AM/TR	CR NE	G9 24×60W G9					DIM 1 4.940,00
PUPPET SP R3	BC/SF CR/TR FU/TR AM/TR	CR NE	G9 3×60W G9					DIM 1 960,00

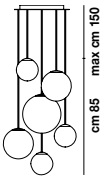

ø cm 58
ø 23"

PUPPET SP R6

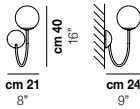

PUPPET AP P

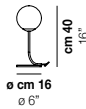
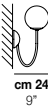

PUPPET LT P

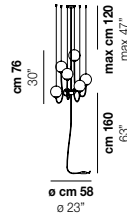

PUPPET PT 6 P

codice / code	vetro / glass	struttura / frame	elettrificazione / lamping	CL. IP	EU cert.	International cert.	dimmer	€
PUPPET SP R6	BC/SF CR/TR FU/TR AM/TR	CR NE	G9 6×60W G9					DIM 1 1.480,00
PUPPET AP P	BC/SF CR/TR FU/TR AM/TR	CR NE	G9 1×60W G9	⊥ IP20			DIM 1 230,00	
PUPPET LT P	BC/SF CR/TR FU/TR AM/TR	CR NE	G9 1×60W G9	⊥ IP20			DIM 4A 188,00	
PUPPET PT 6 P	BC/SF CR/TR FU/TR AM/TR	CR NE	G9 6×60W G9	⊥ IP20			1.250,00	

finitura vetro / glass finish | finitura struttura / frame finish

RIGA

studio tecnico Vetreria Vistosi 2002



CR/GA



OR

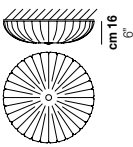

RIGA PL 60

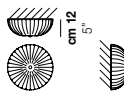

RIGA PP 30

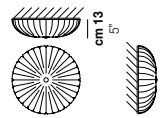

RIGA PP 45

codice / code	vetro / glass	struttura / frame	elettrificazione / lamping	CL. IP	EU cert.	International cert.	dimmer	€
RIGA PL 60	CR/GA	OR	E27 3×77W E27	⊥ IP20				DIM 1 340,00
RIGA PP 30	CR/GA	OR	E14 2×60W E14	⊥ IP20				DIM 1 150,00
RIGA PP 45	CR/GA	OR	E27 3×77W E27	⊥ IP20				DIM 1 220,00

RINA

design Barbara Maggiolo 2009

finitura vetro / glass finish | finitura struttura / frame finish

BC/MU

BC

NI

NIB

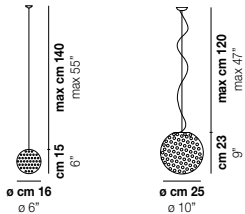

RINA SP 16



RINA SP 25

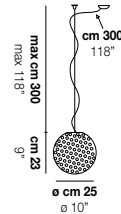

RINA SP 25 D1

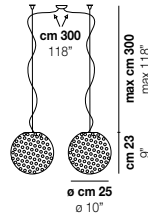

RINA SP 25 D2

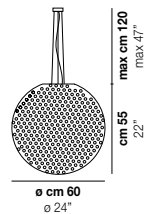

RINA SP 60

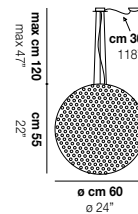

RINA SP 60 D1

codice / code	vetro / glass	struttura / frame	elettrificazione / lamping				CL. IP	EU cert.	International cert.	dimmer	€
RINASP16	BC/MU	NI	G9	1x60W G9				CE CB EAC		DIM 1	198,00
RINASP16	BCMU	NI	LED B	5W	600 lm	2.700 K	IP20	CE CB EAC		DIM 3	348,00
RINASP25	BCMU	NI	E27	1x77W E27				CE CB EAC		DIM 1	295,00
RINASP25	BCMU	NI	LED C	5W	600 lm	2.700 K	IP20	CE CB EAC		DIM 3	395,00
RINASP25D1	BCMU	NI	E27	1x77W E27				CE CB EAC		DIM 1	315,00
RINASP25D1	BCMU	NI	LED C	5W	600 lm	2.700 K	IP20	CE CB EAC		DIM 3	415,00
RINASP25D2	BCMU	NI	E27	2x77W E27				CE CB EAC		DIM 1	610,00
RINASP60	BC/MU	NIB	E27	3x77W E27				CE CB EAC		DIM 1	1.020,00
RINASP60	BC/MU	NIB	LED G	19,5W	2850 lm	3.000 K	IP20	CE CB EAC		DIM 3	1.150,00
RINASP60	BCMU	NIB	LED J	10W	1120 lm	3.000 K	IP20	CE CB EAC		DIM 2	1.130,00
RINASP60D1	BCMU	NIB	E27	3x77W E27				CE CB EAC		DIM 1	1.060,00
RINASP60D1	BCMU	NIB	LED G	19,5W	2850 lm	3.000 K	IP20	CE CB EAC		DIM 3	1.190,00
RINASP60D1	BCMU	NIB	LED J	10W	1120 lm	3.000 K	IP20	CE CB EAC		DIM 2	1.170,00

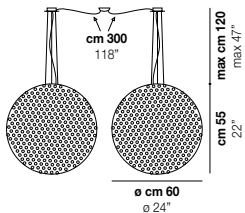

RINA SP 60 D2

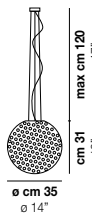

RINA SP 35C

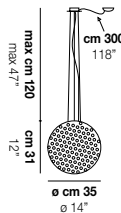

RINA SP 35C D1

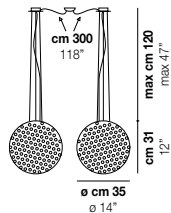

RINA SP 35C D2

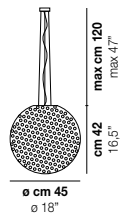

RINA SP 45C

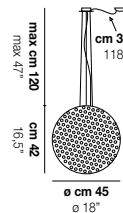

RINA SP 45C D1

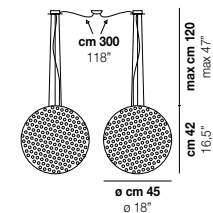

RINA SP 45C D2

codice / code	vetro / glass	struttura / frame	elettrificazione / lamping				CL. IP	EU cert.	International cert.	dimmer	€
RINASP60D2	BC/MU	NIB	E27	6x77W E27				CE CB EAC		DIM 1	2.080,00
RINASP35C	BCMU	NI	E27	1x77W E27				CE CB EAC		DIM 1	480,00
RINASP35C	BCMU	NI	LED F	12,5W	1650 lm	3.000 K	IP20	CE CB EAC		DIM 3	585,00
RINASP35C	BCMU	NI	LED I	10W	1120 lm	3.000 K	IP20	CE CB EAC		DIM 2	565,00
RINASP35CD1	BCMU	NI	E27	1x77W E27				CE CB EAC		DIM 1	510,00
RINASP35CD1	BCMU	NI	LED F	12,5W	1650 lm	3.000 K	IP20	CE CB EAC		DIM 3	615,00
RINASP35CD1	BCMU	NI	LED I	10W	1120 lm	3.000 K	IP20	CE CB EAC		DIM 2	595,00
RINASP35CD2	BCMU	NI	E27	2x77W E27				CE CB EAC		DIM 1	1.000,00
RINASP45C	BC/MU	NI	E27	3x77W E27				CE CB EAC		DIM 1	590,00
RINASP45C	BCMU	NI	LED F	12,5W	1650 lm	3.000 K	IP20	CE CB EAC		DIM 3	695,00
RINASP45C	BCMU	NI	LED I	10W	1120 lm	3.000 K	IP20	CE CB EAC		DIM 2	675,00
RINASP45CD1	BCMU	NI	E27	3x77W E27				CE CB EAC		DIM 1	620,00
RINASP45CD1	BCMU	NI	LED F	12,5W	1650 lm	3.000 K	IP20	CE CB EAC		DIM 3	725,00
RINASP45CD1	BCMU	NI	LED I	10W	1120 lm	3.000 K	IP20	CE CB EAC		DIM 2	705,00
RINASP45CD2	BCMU	NI	E27	6x77W E27				CE CB EAC		DIM 1	1.210,00

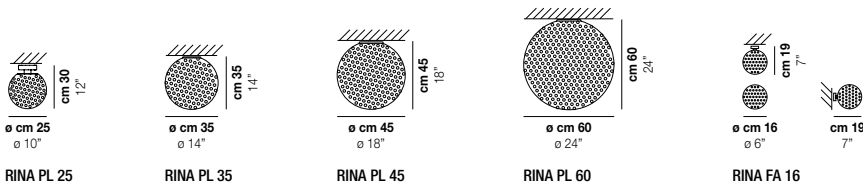

codice / code	vetro / glass	struttura / frame	elettrificazione / lamping	CL. IP	EU cert.	International cert.	dimmer	€
RINA PL 25	BC/MU	NI	E27 1x77W E27	⊥ IP20	CE CB	ERC	DIM 1	335,00
RINA PL 35	BC/MU	NI	E27 1x77W E27	⊥ IP20	CE CB	ERC	DIM 1	350,00
RINA PL 35	BC/MU	NI	LED F 12,5W 1650 lm 3.000 K	⊥ IP20	CE CB	ERC	DIM 3	450,00
RINA PL 35	BC/MU	NI	LED I 10W 1120 lm 3.000 K	⊥ IP20	CE CB	ERC	DIM 2	435,00
RINA PL 45	BC/MU	BC	E27 3x77W E27	⊥ IP20	CE CB	ERC	DIM 1	470,00
RINA PL 45	BC/MU	NI	LED F 12,5W 1650 lm 3.000 K	⊥ IP20	CE	ERC	DIM 3	570,00
RINA PL 45	BC/MU	NI	LED I 10W 1120 lm 3.000 K	⊥ IP20	CE CB	ERC	DIM 2	555,00
RINA PL 60	BC/MU	BC	E27 3x77W E27	⊥ IP20	CE CB	ERC	DIM 1	950,00
RINA PL 60	BC/MU	NI	LED G 19,5W 2850 lm 3.000 K	⊥ IP20	CE CB	ERC	DIM 3	1.070,00
RINA PL 60	BC/MU	NI	LED J 10W 1120 lm 3.000 K	⊥ IP20	CE CB	ERC	DIM 2	1.050,00
RINA FA 16	BC/MU	NI	G9 1x60W G9	⊥ IP20	CE CB	ERC	DIM 1	215,00
RINA FA 16	BC/MU	NI	LED D 5W 600 lm 2.700 K	⊥ IP20	CE CB	ERC	DIM 3	365,00

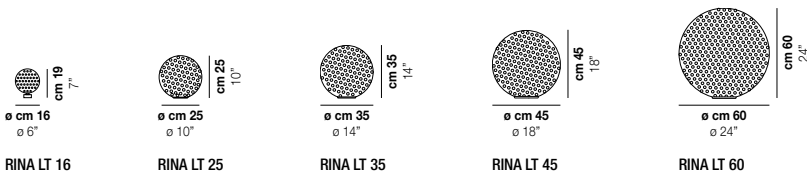

codice / code	vetro / glass	struttura / frame	elettrificazione / lamping	CL. IP	EU cert.	International cert.	dimmer	€
RINALT 16	BC/MU	NI	G9 1x60W G9	⊥ IP20	CE	ERC	DIM 4A	270,00
RINALT 25	BC/MU	NI	E27 1x77W E27	⊥ IP20	CE CB	ERC	DIM 4A	305,00
RINALT 35	BC/MU	NI	E27 1x77W E27	⊥ IP20	CE CB	ERC	DIM 4A	550,00
RINALT 45	BC/MU	NI	E27 1x77W E27	⊥ IP20	CE CB	ERC	DIM 4A	690,00
RINALT 60	BC/MU	NI	E27 3x77W E27	⊥ IP20	CE CB	ERC	DIM 4A	960,00

finitura vetro / glass finish | finitura struttura / frame finish

SABA

studio tecnico Vetreria Vistosi 1998



BC/ST



BC

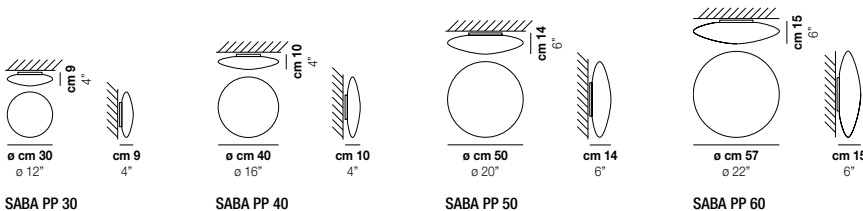

codice / code	vetro / glass	struttura / frame	elettrificazione / lamping	CL. IP	EU cert.	International cert.	dimmer	€
SABA PP 30	BC/ST	BC	E27 1x77W E27	⊥ IP20	CE CB	ERC	DIM 1	86,00
SABA PP 30	BC/ST	BC	LED F 12,5W 1650 lm 3.000 K	⊥ IP20	CE CB	ERC	DIM 3	186,00
SABA PP 30	BC/ST	BC	LED I 10W 1120 lm 3.000 K	⊥ IP20	CE CB	ERC	DIM 2	171,00
SABA PP 40	BC/ST	BC	E27 1x77W E27	⊥ IP20	CE CB	ERC	DIM 1	136,00
SABA PP 40	BC/ST	BC	LED F 12,5W 1650 lm 3.000 K	⊥ IP20	CE CB	ERC	DIM 3	236,00
SABA PP 40	BC/ST	BC	LED I 10W 1120 lm 3.000 K	⊥ IP20	CE CB	ERC	DIM 2	221,00

codice / code	vetro / glass	struttura / frame	elettrificazione / lamping	CL. IP	EU cert.	International cert.	dimmer	€
SABAPP50	BC/ST	BC	E27 2x77W E27	⊥ IP20	CE CB ENEC	ERAC	DIM 1	210,00
SABAPP50	BC/ST	BC	LED G 19,5W 2850 lm 3.000 K	⊥ IP20	CE CB ENEC	ERAC	DIM 3	330,00
SABAPP50	BC/ST	BC	LED J 10W 1120 lm 3.000 K	⊥ IP20	CE CB ENEC	ERAC	DIM 2	310,00
SABAPP60	BC/ST	BC	E27 3x77W E27	⊥ IP20	CE CB ENEC	ERAC	DIM 1	375,00
SABAPP60	BC/ST	BC	LED N 10W 1120 lm 3.000 K	⊥ IP20	CE CB ENEC	ERAC	DIM 2	475,00
SABAPP60	BC/ST	BC	LED O 19,5W 2850 lm 3.000 K	⊥ IP20	CE CB ENEC	ERAC	DIM 3	515,00

SATA

design Favaretto&Partners 2017

finitura vetro / glass finish | finitura struttura / frame finish

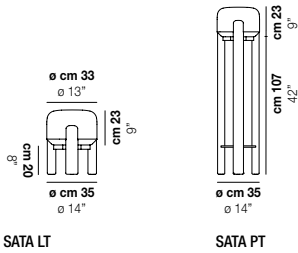
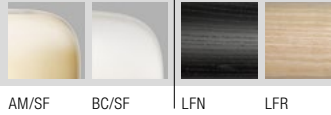

SATA LT

SATA PT

codice / code	vetro / glass	struttura / frame	elettrificazione / lamping	CL. IP	EU cert.	International cert.	dimmer	€
SATALT	AM/SF BC/SF	LFR LFN	E27 1x77W E27	⊥ IP20	CE ENEC	ERAC	DIM 4A	500,00
SATAPT	AM/SF BC/SF	LFR LFN	E27 1x77W E27	⊥ IP20	CE ENEC	ERAC		720,00

finitura vetro / glass finish | finitura struttura / frame finish



SCUSEV

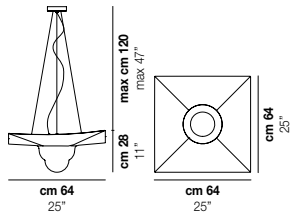

SCUSEV SP

codice / code	vetro / glass	struttura / frame	elettrificazione / lamping	CL. IP	EU cert.	International cert.	dimmer	€
SCUSEVSP	BC/SF	NN	E27 1x77W E27	⊥ IP20	CE CB ENEC	ERAC	DIM 1	1.250,00
SCUSEVSP	BC/SF	NN	LED C 5W 600 lm 2.700 K	⊥ IP20	CE CB ENEC	ERAC	DIM 3	1.350,00

finitura vetro / glass finish | finitura struttura / frame finish

SEMAI

design Alberto Saggia e Valerio Sommella 2015



BC/LU

BC

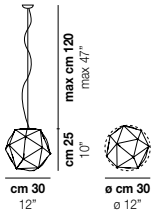

SEMAI SP P

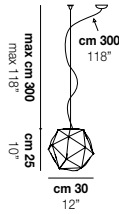

SEMAI SP P D1

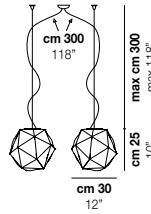

SEMAI SP P D2

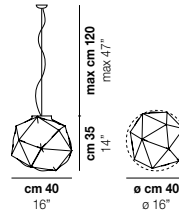

SEMAI SP M

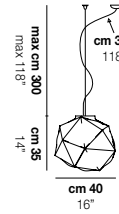

SEMAI SP M D1

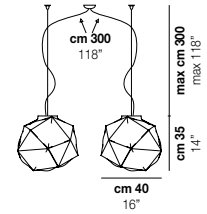

SEMAI SP M D2

codice / code	vetro / glass	struttura / frame	elettrificazione / lamping	CL. IP	EU cert.	International cert.	dimmer	€
SEMAI SPP	BC/LU	BC	E27 1x77W E27		CE CB ENEC	ERAC	DIM 1	365,00
SEMAI SPP	BC/LU	BC	LED C 5W 600 lm 2.700 K	IP20	CE CB ENEC	ERAC	DIM 3	475,00
SEMAI SPP D1	BC/LU	BC	E27 1x77W E27		CE CB ENEC	ERAC	DIM 1	385,00
SEMAI SPP D1	BC/LU	BC	LED C 5W 600 lm 2.700 K	IP20	CE CB ENEC	ERAC	DIM 3	495,00
SEMAI SPP D2	BC/LU	BC	E27 2x77W E27		CE CB ENEC	ERAC	DIM 1	750,00
SEMAI SPM	BC/LU	BC	E27 1x77W E27		CE CB ENEC	ERAC	DIM 1	500,00
SEMAI SPM	BC/LU	BC	LED F 12,5W 1650 lm 3.000 K	IP20	CE CB ENEC	ERAC	DIM 3	605,00
SEMAI SPM	BC/LU	BC	LED I 10W 1120 lm 3.000 K	IP20	CE CB ENEC	ERAC	DIM 2	585,00
SEMAI SPM D1	BC/LU	BC	E27 1x77W E27		CE CB ENEC	ERAC	DIM 1	520,00
SEMAI SPM D1	BC/LU	BC	LED F 12,5W 1650 lm 3.000 K	IP20	CE CB ENEC	ERAC	DIM 3	625,00
SEMAI SPM D1	BC/LU	BC	LED I 10W 1120 lm 3.000 K	IP20	CE CB ENEC	ERAC	DIM 2	605,00
SEMAI SPM D2	BC/LU	BC	E27 2x77W E27		CE CB ENEC	ERAC	DIM 1	1.020,00

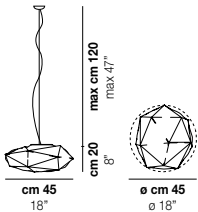

SEMAI SP G

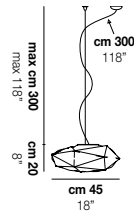

SEMAI SP G D1

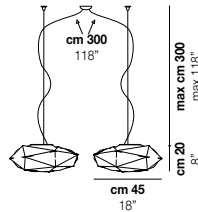

SEMAI SP G D2

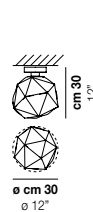

SEMAI PL P

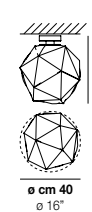

SEMAI PL M

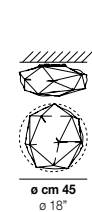

SEMAI PP G



SEMAI LT P

codice / code	vetro / glass	struttura / frame	elettrificazione / lamping	CL. IP	EU cert.	International cert.	dimmer	€
SEMAI SPG	BC/LU	BC	E27 2x77W E27		CE CB ENEC	ERAC	DIM 1	500,00
SEMAI SPG	BC/LU	BC	LED F 12,5W 1650 lm 3.000 K	IP20	CE CB ENEC	ERAC	DIM 3	630,00
SEMAI SPG	BC/LU	BC	LED I 10W 1120 lm 3.000 K	IP20	CE CB ENEC	ERAC	DIM 2	585,00
SEMAI SPG D1	BC/LU	BC	E27 2x77W E27		CE CB ENEC	ERAC	DIM 1	520,00
SEMAI SPG D1	BC/LU	BC	LED F 12,5W 1650 lm 3.000 K	IP20	CE CB ENEC	ERAC	DIM 3	625,00
SEMAI SPG D1	BC/LU	BC	LED I 10W 1120 lm 3.000 K	IP20	CE CB ENEC	ERAC	DIM 2	605,00
SEMAI SPG D2	BC/LU	BC	E27 4x77W E27		CE CB ENEC	ERAC	DIM 1	1.020,00
SEMAI PLP	BC/LU	BC	E14 1x46W E14	IP20	CE CB ENEC	ERAC	DIM 1	230,00
SEMAI PLP	BC/LU	BC	LED E 6W 825 lm 3.000 K	IP20	CE CB ENEC	ERAC	DIM 3	345,00
SEMAI PLM	BC/LU	BC	E27 1x77W E27	IP20	CE CB ENEC	ERAC	DIM 1	400,00
SEMAI PLM	BC/LU	BC	LED C 5W 600 lm 2.700 K	IP20	CE CB ENEC	ERAC	DIM 3	500,00
SEMAI PPG	BC/LU	BC	E27 2x77W E27	IP20	CE CB ENEC	ERAC	DIM 1	410,00
SEMAI PPG	BC/LU	BC	LED F 12,5W 1650 lm 3.000 K	IP20	CE CB ENEC	ERAC	DIM 3	510,00
SEMAI PPG	BC/LU	BC	LED I 10W 1120 lm 3.000 K	IP20	CE CB ENEC	ERAC	DIM 2	510,00
SEMAI LTP	BC/LU	BC	E14 1x46W E14	IP20	CE CB ENEC	ERAC	DIM 4A	275,00

SISSI

design Barbara Maggiolo 2009

finitura vetro / glass finish | finitura struttura / frame finish



BC/LU | CR/RI | CR

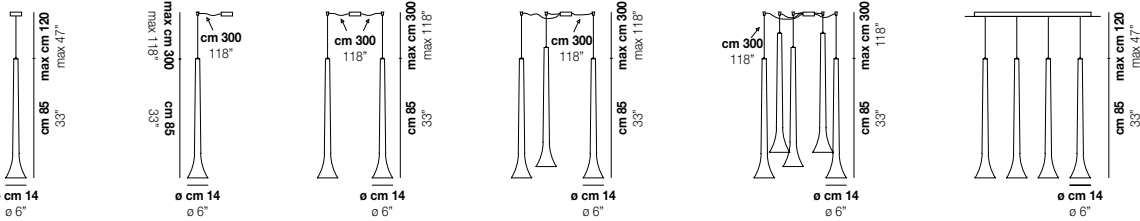

SISSI SP

SISSI SP D1

SISSI SP D2

SISSI SP D3

SISSI SP D5

SISSI SP L4

codice / code	vetro / glass	struttura / frame	elettrificazione / lamping	CL. IP	EU cert.	International cert.	dimmer	€
SISSISP	BC/LU	CR	GU10 1×75W GU10		CE	EAC	DIM 1	265,00
SISSISP	CR/RI	CR	GU10 1×75W GU10		CE	EAC	DIM 1	295,00
SISSISPD1	BC/LU	CR	GU10 1×75W GU10		CE	EAC	DIM 1	295,00
SISSISPD1	CR/RI	CR	GU10 1×75W GU10		CE	EAC	DIM 1	315,00
SISSISPD2	BC/LU	CR	GU10 2×75W GU10		CE	EAC	DIM 1	590,00
SISSISPD2	CR/RI	CR	GU10 2×75W GU10		CE	EAC	DIM 1	610,00
SISSISPD3	BC/LU	CR	GU10 3×75W GU10		CE	EAC	DIM 1	840,00
SISSISPD3	CR/RI	CR	GU10 3×75W GU10		CE	EAC	DIM 1	900,00
SISSISPD5	BC/LU	CR	GU10 5×75W GU10		CE	EAC	DIM 1	1.380,00
SISSISPD5	CR/RI	CR	GU10 5×75W GU10		CE	EAC	DIM 1	1.480,00
SISSISPL4	BC/LU	CR	GU10 5×75W GU10		CE	EAC	DIM 1	1.100,00
SISSISPL4	CR/RI	CR	GU10 5×75W GU10		CE	EAC	DIM 1	1.200,00

finitura vetro / glass finish | finitura struttura / frame finish



BC/CR | NI

SMOKING

design Paolo Crepax 2003

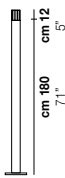
ø cm 25
ø 10"

SMOKING PT

codice / code	vetro / glass	struttura / frame	elettrificazione / lamping	CL. IP	EU cert.	International cert.	dimmer	€
SMOKINGPT	BC/CR	NI	E27 1×205W E27	IP20	CE	EAC		940,00

finitura vetro / glass finish | finitura struttura / frame finish

SOFT

studio tecnico Vetreria Vistosi 1998

BC

BC

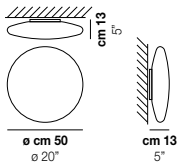

SOFT PP 50 3

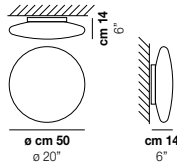

SOFT PP 50

codice / code	vetro / glass	struttura / frame	elettrificazione / lamping	CL. IP	EU cert.	International cert.	dimmer	€
SOFTPP503	BC	BC	E27 3×77W E27	⊥ IP20	CE CB EAC	CCC	DIM 1	168,00
SOFTPP50	BC	BC	LED W 10W 1120 lm 3.000 K	⊥ IP20	CE EAC		DIM 2	246,00
SOFTPP50	BC	BC	LED X 19,5W 2850 lm 3.000 K	⊥ IP20	CE EAC		DIM 3	261,00

finitura vetro / glass finish | finitura struttura / frame finish

SOGNO

studio tecnico Vetreria Vistosi 2003

BC/ST

BC

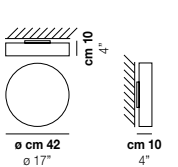

SOGNO PP 42

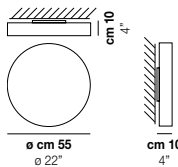

SOGNO PP 55

codice / code	vetro / glass	struttura / frame	elettrificazione / lamping	CL. IP	EU cert.	International cert.	dimmer	€
SOGNO PP 42	BC/ST	BC	E27 2×77W E27	⊥ IP20	CE CB EAC	CCC	DIM 1	198,00
SOGNO PP 42	BC/ST	BC	LED G 19,5W 2850 lm 3.000 K	⊥ IP20	CE CB EAC		DIM 3	318,00
SOGNO PP 42	BC/ST	BC	LED J 10W 1120 lm 3.000 K	⊥ IP20	CE CB EAC		DIM 2	298,00
SOGNO PP 55	BC/ST	BC	E27 2×77W E27	⊥ IP20	CE CB EAC	CCC	DIM 1	345,00
SOGNO PP 55	BC/ST	BC	LED G 19,5W 2850 lm 3.000 K	⊥ IP20	CE CB EAC		DIM 3	465,00
SOGNO PP 55	BC/ST	BC	LED J 10W 1120 lm 3.000 K	⊥ IP20	CE CB EAC		DIM 2	445,00

finitura vetro / glass finish | finitura struttura / frame finish

SPIRIT

design Marco Acerbis 2013

BC/LU

CR/TR

NI

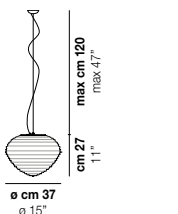

SPIRIT SP 37

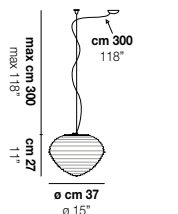

SPIRIT SP 37 D1

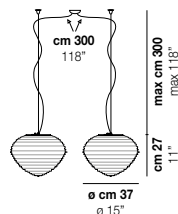

SPIRIT SP 37 D2

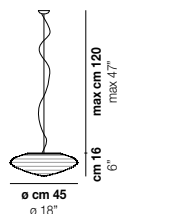

SPIRIT SP 45

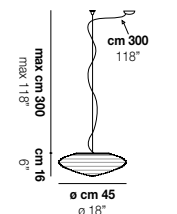

SPIRIT SP 45 D1

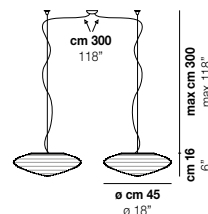

SPIRIT SP 45 D2

codice / code	vetro / glass	struttura / frame	elettrificazione / lamping	CL. IP	EU cert.	International cert.	dimmer	€
SPIRITSP37	BC/LU	NI	E27 1×77W E27		CE CB EAC	CCC	DIM 1	385,00
SPIRITSP37	BC/LU	NI	LED F 12,5W 1650 lm 3.000 K	⊥ IP20	CE CB EAC		DIM 3	490,00

codice / code	vetro / glass	struttura / frame	elettrificazione / lamping	CL. IP	EU cert.	International cert.	dimmer	€
SPIRITSP37	BC/LU	NI	LED I 10W 1120 lm 3.000 K	⊥ IP20	CE CB EAC	PS	DIM 2	470,00
SPIRITSP37	CR/TR	NI	E27 1x77W E27		CE CB EAC	PS	DIM 1	410,00
SPIRITSP37	CR/TR	NI	LED F 12,5W 1650 lm 3.000 K	⊥ IP20	CE CB EAC		DIM 3	515,00
SPIRITSP37	CR/TR	NI	LED I 10W 1120 lm 3.000 K	⊥ IP20	CE CB EAC		DIM 2	495,00
SPIRITSP37D1	BC/LU	NI	E27 1x77W E27		CE CB EAC		DIM 1	410,00
SPIRITSP37D1	BC/LU	NI	LED F 12,5W 1650 lm 3.000 K	⊥ IP20	CE CB EAC		DIM 3	515,00
SPIRITSP37D1	BC/LU	NI	LED I 10W 1120 lm 3.000 K	⊥ IP20	CE CB EAC		DIM 2	495,00
SPIRITSP37D1	CR/TR	NI	E27 1x77W E27		CE CB EAC		DIM 1	430,00
SPIRITSP37D1	CR/TR	NI	LED F 12,5W 1650 lm 3.000 K	⊥ IP20	CE CB EAC		DIM 3	535,00
SPIRITSP37D1	CR/TR	NI	LED I 10W 1120 lm 3.000 K	⊥ IP20	CE CB EAC		DIM 2	515,00
SPIRITSP37D2	BC/LU	NI	E27 2x77W E27		CE CB EAC		DIM 1	800,00
SPIRITSP37D2	CR/TR	NI	E27 2x77W E27		CE CB EAC		DIM 1	840,00
SPIRITSP45	BC/LU	NI	E27 2x77W E27		CE CB EAC	PS	DIM 1	365,00
SPIRITSP45	BC/LU	NI	LED G 19,5W 2850 lm 3.000 K	⊥ IP20	CE CB EAC		DIM 3	495,00
SPIRITSP45	BC/LU	NI	LED J 10W 1120 lm 3.000 K	⊥ IP20	CE CB EAC		DIM 2	475,00
SPIRITSP45	CR/TR	NI	E27 2x77W E27		CE CB EAC	PS	DIM 1	385,00
SPIRITSP45	CR/TR	NI	LED G 19,5W 2850 lm 3.000 K	⊥ IP20	CE CB EAC		DIM 3	515,00
SPIRITSP45	CR/TR	NI	LED J 10W 1120 lm 3.000 K	⊥ IP20	CE CB EAC		DIM 2	495,00
SPIRITSP45D1	BC/LU	NI	E27 2x77W E27		CE CB EAC		DIM 1	385,00
SPIRITSP45D1	BC/LU	NI	LED G 19,5W 2850 lm 3.000 K	⊥ IP20	CE CB EAC		DIM 3	515,00
SPIRITSP45D1	BC/LU	NI	LED J 10W 1120 lm 3.000 K	⊥ IP20	CE CB EAC		DIM 2	495,00
SPIRITSP45D1	CR/TR	NI	E27 2x77W E27		CE CB EAC		DIM 1	410,00
SPIRITSP45D1	CR/TR	NI	LED G 19,5W 2850 lm 3.000 K	⊥ IP20	CE CB EAC		DIM 3	540,00
SPIRITSP45D1	CR/TR	NI	LED J 10W 1120 lm 3.000 K	⊥ IP20	CE CB EAC		DIM 2	520,00
SPIRITSP45D2	BC/LU	NI	E27 4x77W E27		CE CB EAC		DIM 1	750,00
SPIRITSP45D2	CR/TR	NI	E27 4x77W E27		CE CB EAC		DIM 1	800,00

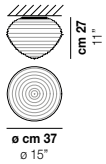

SPIRIT PL 37

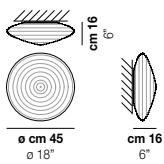

SPIRIT PP 45

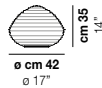

SPIRIT LT 37

codice / code	vetro / glass	struttura / frame	elettrificazione / lamping	CL. IP	EU cert.	International cert.	dimmer	€
SPIRITPL37	BC/LU	NI	E27 1x77W E27	⊥ IP20	CE CB EAC	PS	DIM 1	295,00
SPIRITPL37	BC/LU	NI	LED F 12,5W 1650 lm 3.000 K	⊥ IP20	CE CB EAC		DIM 3	400,00
SPIRITPL37	BC/LU	NI	LED I 10W 1120 lm 3.000 K	⊥ IP20	CE CB EAC		DIM 2	380,00
SPIRITPL37	CR/TR	NI	E27 1x77W E27	⊥ IP20	CE CB EAC	PS	DIM 1	315,00
SPIRITPL37	CR/TR	NI	LED F 12,5W 1650 lm 3.000 K	⊥ IP20	CE CB EAC		DIM 3	420,00
SPIRITPL37	CR/TR	NI	LED I 10W 1120 lm 3.000 K	⊥ IP20	CE CB EAC		DIM 2	400,00
SPIRITPP45	BC	NI	LED G 19,5W 2850 lm 3.000 K	⊥ IP20	CE CB EAC		DIM 3	395,00
SPIRITPP45	BC	NI	LED J 10W 1120 lm 3.000 K	⊥ IP20	CE CB EAC		DIM 2	375,00
SPIRITPP45	BC/LU	NI	E27 2x77W E27	⊥ IP20	CE CB EAC	PS	DIM 1	275,00
SPIRITPP45	CR/TR	NI	E27 2x77W E27	⊥ IP20	CE CB EAC	PS	DIM 1	295,00
SPIRITPP45	CR/TR	NI	LED G 19,5W 2850 lm 3.000 K	⊥ IP20	CE CB EAC		DIM 3	425,00
SPIRITPP45	CR/TR	NI	LED J 10W 1120 lm 3.000 K	⊥ IP20	CE CB EAC		DIM 2	395,00
SPIRITLT37	BC/LU	NI	E27 1x77W E27	□ IP20	CE CB EAC	PS	DIM 4A	295,00
SPIRITLT37	CR/TR	NI	E27 1x77W E27	□ IP20	CE CB EAC	PS	DIM 4A	315,00

finitura vetro / glass finish | finitura struttura / frame finish

STARDUST

design Francesco Lucchese 2015



CR/RI

NN

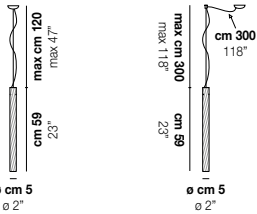

STARDUST SP

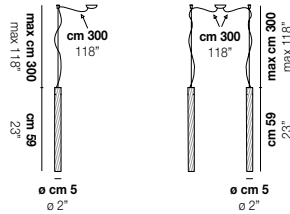

STARDUST SP D1

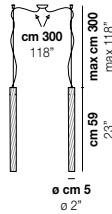

STARDUST SP D2

codice / code	vetro / glass	struttura / frame	elettrificazione / lamping	CL. IP	EU cert.	International cert.	dimmer	€
STARDUST SP	CR/RI	NN	G9 1x48W G9				DIM 1	250,00
STARDUST SP D1	CR/RI	NN	G9 1x48W G9				DIM 1	275,00
STARDUST SP D2	CR/RI	NN	G9 2x48W G9				DIM 1	520,00

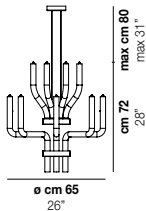

STARDUST SP DOP

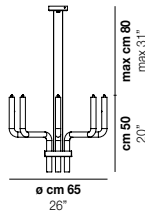

STARDUST SP Q

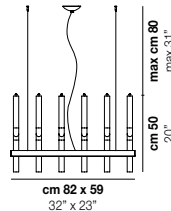

STARDUST SP R

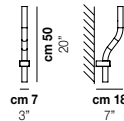

STARDUST AP 1

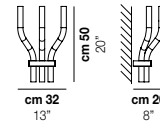

STARDUST AP 3

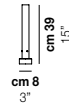

STARDUST LT

codice / code	vetro / glass	struttura / frame	elettrificazione / lamping	CL. IP	EU cert.	International cert.	dimmer	€
STARDUST SP DOP	CR/RI	NN	G9 16x48W G9				DIM 1	2.500,00
STARDUST SP Q	CR/RI	NN	G9 8x48W G9				DIM 1	1.300,00
STARDUST SP R	CR/RI	NN	G9 12x48W G9				DIM 1	2.290,00
STARDUST AP 1	CR/RI	NN	G9 1x60W G9	⊥ IP20			DIM 1	188,00
STARDUST AP 3	CR/RI	NN	G9 3x60W G9	⊥ IP20			DIM 1	570,00
STARDUST LT	CR/RI	NN	G9 1x48W G9	⊥ IP20			DIM 4A	188,00

finitura vetro / glass finish | finitura struttura / frame finish

STARNET

design Gianni Veneziano e Luciana Di Virgilio | Veneziano+Team 2015

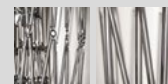

CR

CR/BC

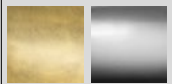

BR

CR

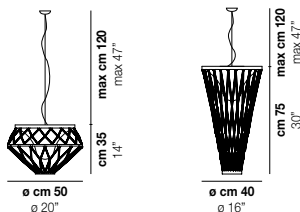

STARNET SP 1

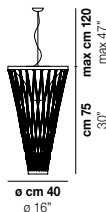

STARNET SP 2

codice / code	vetro / glass	struttura / frame	elettrificazione / lamping	CL. IP	EU cert.	International cert.	dimmer	€
STARNET SP 1	CR	BR	E27 1x77W E27				DIM 1	980,00
STARNET SP 1	CR	BR	LED F 12,5W 1650 lm 3.000 K	⊥ IP20			DIM 3	1.085,00
STARNET SP 1	CR	BR	LED I 10W 1120 lm 3.000 K	⊥ IP20			DIM 2	1.065,00

codice / code	vetro / glass	struttura / frame	elettrificazione / lamping	CL. IP	EU cert.	International cert.	dimmer	€
STARNETSP 1	CR	CR	E27 1x77W E27		CE CB EAC	CCC	DIM 1	1.020,00
STARNETSP 1	CR/BC	CR	LED F 12,5W 1650 lm 3.000 K	⊥ IP20	CE CB EAC		DIM 3	1.125,00
STARNETSP 1	CR/BC	CR	LED I 10W 1120 lm 3.000 K	⊥ IP20	CE CB EAC		DIM 2	1.105,00
STARNETSP 2	CR	BR	E27 1x77W E27		CE CB EAC	CCC	DIM 1	1.550,00
STARNETSP 2	CR	BR	LED F 12,5W 1650 lm 3.000 K	⊥ IP20	CE CB EAC		DIM 3	1.655,00
STARNETSP 2	CR	BR	LED I 10W 1120 lm 3.000 K	⊥ IP20	CE CB EAC		DIM 2	1.635,00
STARNETSP 2	CR	CR	E27 1x77W E27		CE CB EAC	CCC	DIM 1	1.620,00
STARNETSP 2	CR/BC	CR	LED F 12,5W 1650 lm 3.000 K	⊥ IP20	CE CB EAC		DIM 3	1.725,00
STARNETSP 2	CR/BC	CR	LED I 10W 1120 lm 3.000 K	⊥ IP20	CE CB EAC		DIM 2	1.705,00

finitura vetro / glass finish | finitura struttura / frame finish

STONE

design Hangar Design Group 2017



CR/BC FU/BC NN

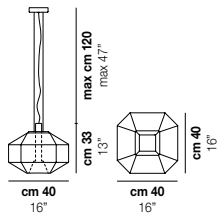

STONE SP

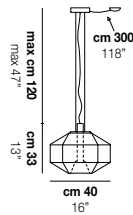

STONE SP D1

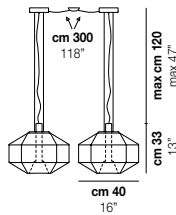

STONE SP D2

codice / code	vetro / glass	struttura / frame	elettrificazione / lamping	CL. IP	EU cert.	International cert.	dimmer	€
STONESP	CR/BC FU/BC	NN	E14 1x48W E14	⊥ IP20	CE CB EAC	CCC	DIM 1	620,00
STONESP	CR/BC FU/BC	NN	LED 2W+8W 1110 lm	⊥ IP20	CE EAC	PS		920,00
STONESPD1	CR/BC FU/BC	NN	E14 1x48W E14	⊥ IP20	CE CB EAC	CCC PS	DIM 1	640,00
STONESPD1	CR/BC FU/BC	NN	LED 2W+8W 1110 lm	⊥ IP20	CE EAC	PS		920,00
STONESPD2	CR/BC FU/BC	NN	E14 2x48W E14	⊥ IP20	CE CB EAC	CCC PS	DIM 1	1.290,00

finitura vetro / glass finish | finitura struttura / frame finish

SURFACE

design Giovanni Barbato 2017



BC BC/FU BC/TB BC/VA NI

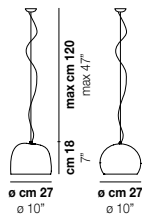

SURFACE SP P

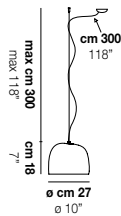

SURFACE SP P D1

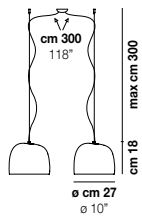

SURFACE SP P D2

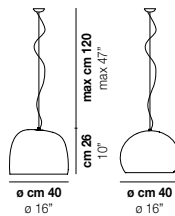

SURFACE SP G

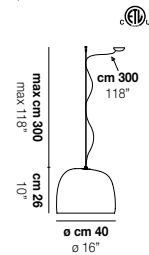

SURFACE SP G D1

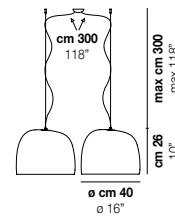

SURFACE SP G D2

codice / code	vetro / glass	struttura / frame	elettrificazione / lamping	CL. IP	EU cert.	International cert.	dimmer	€
SURFACESPP	BC BC/FU BC/TB BC/VA	NI	E27 1x77W E27		CE CB EAC	CCC	DIM 1	240,00
SURFACESPP	BC BC/VA	NI	LED C 5W 600 lm 2.700 K	⊥ IP20	CE CB EAC		DIM 3	340,00
SURFACESPP	BC/FU BC/TB	NI	LED C 5W 600 lm 2.700 K	⊥ IP20	CE CB EAC		DIM 3	350,00
SURFACESPP D1	BC BC/FU BC/TB BC/VA	NI	E27 1x77W E27		CE CB EAC	CCC	DIM 1	260,00
SURFACESPP D1	BC BC/FU BC/TB BC/VA	NI	LED C 5W 600 lm 2.700 K	⊥ IP20	CE CB EAC		DIM 3	360,00
SURFACESPP D	BC BC/FU BC/TB BC/VA	NI	E27 2x77W E27		CE CB EAC	CCC	DIM 1	500,00
SURFACESPG	BC BC/FU BC/TB BC/VA	NI	E27 1x77W E27		CE CB EAC	CCC	DIM 1	295,00
SURFACESPG	BC	NI	LED C 5W 600 lm 2.700 K	⊥ IP20	CE CB EAC		DIM 3	395,00

codice / code	vetro / glass	struttura / frame	elettrificazione / lamping	CL. IP	EU cert.	International cert.	dimmer	€
SURFACE SP G	BC/FU BC/TB	NI	LED C 5W 600 lm 2.700 K	⊥ IP20	CE CB EAC	ERC	DIM 3	405,00
SURFACE SP G	BC/VA	NI	LED C 5W 600 lm 2.700 K	⊥ IP20	CE CB EAC	ERC	DIM 3	380,00
SURFACE SP GD1	BC BC/FU BC/TB BC/VA	NI	E27 1x77W E27		CE CB EAC	ERC	DIM 1	315,00
SURFACE SP GD1	BC BC/FU BC/TB BC/VA	NI	LED C 5W 600 lm 2.700 K	⊥ IP20	CE CB EAC	ERC	DIM 3	415,00
SURFACE SP GD2	BC BC/FU BC/TB BC/VA	NI	E27 2x77W E27		CE CB EAC	ERC	DIM 1	610,00

finitura vetro / glass finish | finitura struttura / frame finish

TORCELLO

studio tecnico Vetreria Vistosi 2002

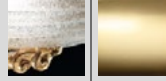

CR/GA | OR

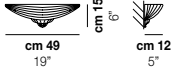
**TORCELLO AP**

codice / code	vetro / glass	struttura / frame	elettrificazione / lamping	CL. IP	EU cert.	International cert.	dimmer	€
TORCELLO AP	CR/GA	OR	R7S 1x80W R7S	⊥ IP20	CE	ERC	DIM 1	230,00

finitura vetro / glass finish | finitura struttura / frame finish

TREPAI

design Favaretto&Partners 2013

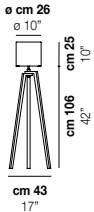

BC | FU/DI | LNO

**TREPAI PT**

codice / code	vetro / glass	struttura / frame	elettrificazione / lamping	CL. IP	EU cert.	International cert.	dimmer	€
TREPAI PT	BC	LNO	E27 1x77W E27	⊥ IP20	CE	ERC		560,00
TREPAI PT	FU/DI	LNO	E27 1x77W E27	⊥ IP20	CE	ERC		580,00

TUBES

design Matthias Hickl per Lissoni Associati 2005

finitura vetro / glass finish | finitura struttura / frame finish

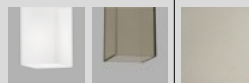

BC/LU FU/TR NO

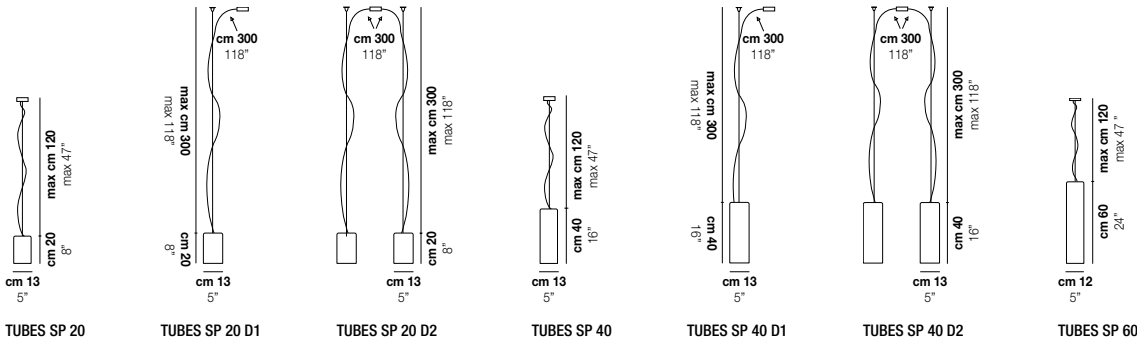

TUBES SP 20 TUBES SP 20 D1 TUBES SP 20 D2 TUBES SP 40 TUBES SP 40 D1 TUBES SP 40 D2 TUBES SP 60

codice / code	vetro / glass	struttura / frame	elettrificazione / lamping			CL. IP	EU cert.	International cert.	dimmer	€
TUBESSP 20	BC/LU FU/TR	NO	E27	1x100W E27		IP20	CE EAC	DIM 1	335,00	
TUBESSP 20	BC/LU FU/TR	NO	LED C	5W 600 lm 2.700 K		IP20	CE CB EAC	DIM 3	435,00	
TUBESSP 20 D1	BC/LU FU/TR	NO	E27	1x100W E27		IP20	CE EAC	DIM 1	365,00	
TUBESSP 20 D1	BC/LU FU/TR	NO	LED C	5W 600 lm 2.700 K		IP20	CE CB EAC	DIM 3	465,00	
TUBESSP 20 D2	BC/LU FU/TR	NO	E27	2x100W E27		IP20	CE EAC	DIM 1	710,00	
TUBESSP 40	BC/LU FU/TR	NO	E27	1x100W E27		IP20	CE EAC	DIM 1	380,00	
TUBESSP 40	BC/LU FU/TR	NO	LED C	5W 600 lm 2.700 K		IP20	CE CB EAC	DIM 3	480,00	
TUBESSP 40 D1	BC/LU FU/TR	NO	E27	1x100W E27		IP20	CE EAC	DIM 1	405,00	
TUBESSP 40 D1	BC/LU FU/TR	NO	LED C	5W 600 lm 2.700 K		IP20	CE CB EAC	DIM 3	505,00	
TUBESSP 40 D2	BC/LU FU/TR	NO	E27	2x100W E27		IP20	CE EAC	DIM 1	790,00	
TUBESSP 60	BC/LU FU/TR	NO	E27	1x100W E27		IP20	CE EAC	DIM 1	430,00	
TUBESSP 60	BC/LU FU/TR	NO	LED C	5W 600 lm 2.700 K		IP20	CE CB EAC	DIM 3	530,00	

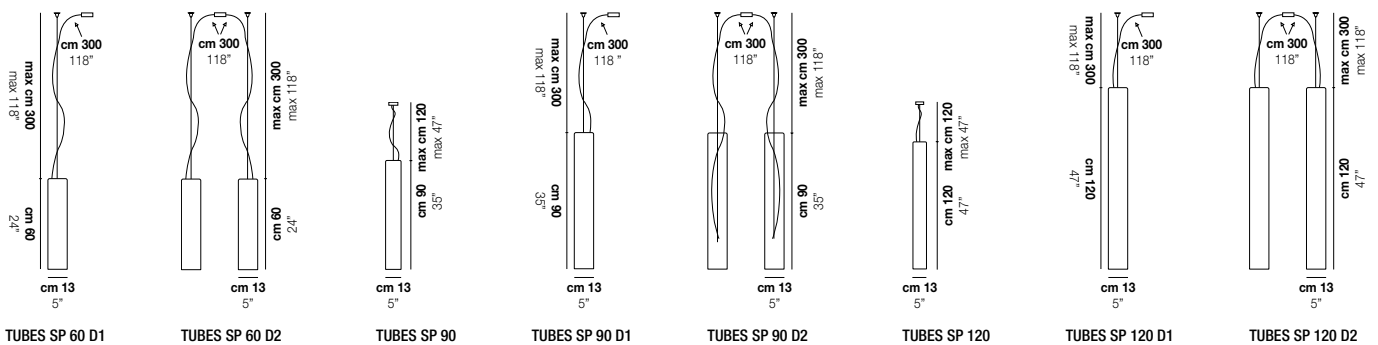

TUBES SP 60 D1 TUBES SP 60 D2 TUBES SP 90 TUBES SP 90 D1 TUBES SP 90 D2 TUBES SP 120 TUBES SP 120 D1 TUBES SP 120 D2

codice / code	vetro / glass	struttura / frame	elettrificazione / lamping			CL. IP	EU cert.	International cert.	dimmer	€
TUBESSP 60 D1	BC/LU FU/TR	NO	E27	1x100W E27		IP20	CE EAC	DIM 1	460,00	
TUBESSP 60 D1	BC/LU FU/TR	NO	LED C	5W 600 lm 2.700 K		IP20	CE CB EAC	DIM 3	560,00	
TUBESSP 60 D2	BC/LU FU/TR	NO	E27	2x100W E27		IP20	CE EAC	DIM 1	890,00	
TUBESSP 90	BC/LU FU/TR	NO	E27	1x100W E27		IP20	CE EAC	DIM 1	590,00	
TUBESSP 90	BC/LU FU/TR	NO	LED C	5W 600 lm 2.700 K		IP20	CE CB EAC	DIM 3	690,00	
TUBESSP 90 D1	BC/LU FU/TR	NO	E27	1x100W E27		IP20	CE EAC	DIM 1	620,00	
TUBESSP 90 D1	BC/LU FU/TR	NO	LED C	5W 600 lm 2.700 K		IP20	CE CB EAC	DIM 3	720,00	
TUBESSP 90 D2	BC/LU FU/TR	NO	E27	2x100W E27		IP20	CE EAC	DIM 1	1.200,00	
TUBESSP 120	BC/LU FU/TR	NO	E27	1x100W E27		IP20	CE EAC	DIM 1	760,00	
TUBESSP 120	BC/LU FU/TR	NO	LED C	5W 600 lm 2.700 K		IP20	CE CB EAC	DIM 3	860,00	
TUBESSP 120 D1	BC/LU FU/TR	NO	E27	1x100W E27		IP20	CE EAC	DIM 1	780,00	

codice / code	vetro / glass	struttura / frame	elettrificazione / lamping	CL. IP	EU cert.	International cert.	dimmer	€
TUBES SP 120 D1	BC/LU FU/TR	NO	LED C 5W 600 lm 2.700 K	IP20	CE	CB certificata ERAC	DIM 3	880,00
TUBES SP 120 D2	BC/LU FU/TR	NO	E27 2x100W E27		CE	ERAC	DIM 1	1.540,00

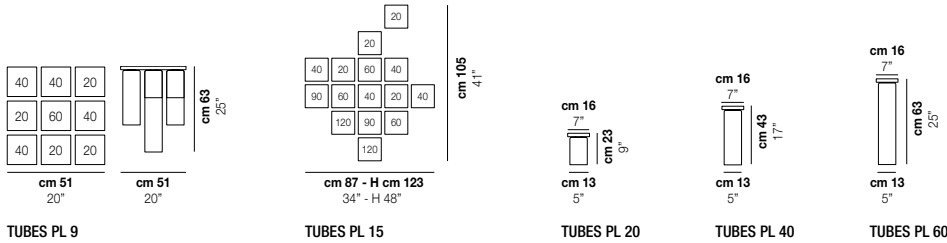

codice / code	vetro / glass	struttura / frame	elettrificazione / lamping	CL. IP	EU cert.	International cert.	dimmer	€
TUBES PL 9	BC/LU FU/TR	NO	E27 9x100W E27	IP20	CE	ERAC	DIM 1	3.020,00
TUBES PL 9	BC/LU FU/TR	NO	LED C 5W 5400 lm 2.700 K	IP20	CE	CB certificata ERAC	DIM 3	3.920,00
TUBES PL 15	BC/LU FU/TR	NO	E27 15x100W E27	IP20	CE	ERAC	DIM 1	6.390,00
TUBES PL 15	BC/LU FU/TR	NO	LED C 5W 9000 lm 2.700 K	IP20	CE	CB certificata ERAC	DIM 3	7.890,00
TUBES PL 20	BC/LU FU/TR	NO	E27 1x100W E27	IP20	CE	ERAC	DIM 1	300,00
TUBES PL 20	BC/LU FU/TR	NO	LED C 5W 600 lm 2.700 K	IP20	CE	CB certificata ERAC	DIM 3	400,00
TUBES PL 40	BC/LU FU/TR	NO	E27 1x100W E27	IP20	CE	ERAC	DIM 1	360,00
TUBES PL 40	BC/LU FU/TR	NO	LED C 5W 600 lm 2.700 K	IP20	CE	CB certificata ERAC	DIM 3	460,00
TUBES PL 60	BC/LU FU/TR	NO	E27 1x100W E27	IP20	CE	ERAC	DIM 1	415,00
TUBES PL 60	BC/LU FU/TR	NO	LED C 5W 600 lm 2.700 K	IP20	CE	CB certificata ERAC	DIM 3	515,00

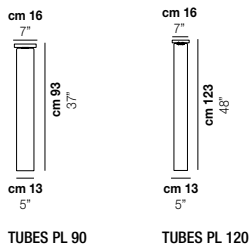

codice / code	vetro / glass	struttura / frame	elettrificazione / lamping	CL. IP	EU cert.	International cert.	dimmer	€
TUBES PL 90	BC/LU FU/TR	NO	E27 1x100W E27	IP20	CE	ERAC	DIM 1	560,00
TUBES PL 90	BC/LU FU/TR	NO	LED C 5W 600 lm 2.700 K	IP20	CE	CB certificata ERAC	DIM 3	660,00
TUBES PL 120	BC/LU FU/TR	NO	E27 1x100W E27	IP20	CE	ERAC	DIM 1	730,00
TUBES PL 120	BC/LU FU/TR	NO	LED C 5W 600 lm 2.700 K	IP20	CE	CB certificata ERAC	DIM 3	830,00

VEGA

design Michele De Lucchi 1982 - restyling 2007

finitura vetro / glass finish | finitura struttura / frame finish



BC

MC/1

BC



VEGA AP

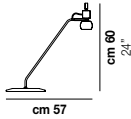

VEGA LT

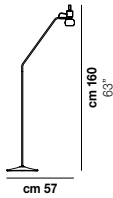

VEGA PT

codice / code	vetro / glass	struttura / frame	elettrificazione / lamping	CL. IP	EU cert.	International cert.	dimmer	€
VEGA AP	BC MC/1	BC	GY6.35 1×50W GY6.35	⚡ IP20	CE	ERC (EUC) (CCC)		355,00
VEGA LT	BC MC/1	BC	GY6.35 1×50W GY6.35	⚡ IP20	CE	ERC (EUC) (CCC)		490,00
VEGA PT	BC MC/1	BC	GY6.35 1×50W GY6.35	⚡ IP20	CE	ERC (EUC) (CCC)		495,00

WITHWHITE

design Mauro Olivieri 2009

finitura vetro / glass finish | finitura struttura / frame finish



BC/ST

BC

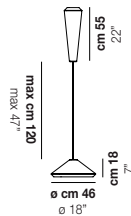

WITHWHITE SP 18 X

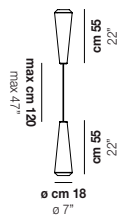

WITHWHITE SP 18 P

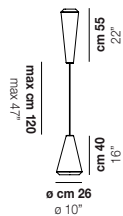

WITHWHITE SP 18 M

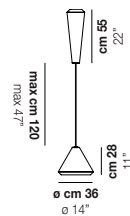

WITHWHITE SP 18 G

codice / code	vetro / glass	struttura / frame	elettrificazione / lamping	CL. IP	EU cert.	International cert.	dimmer	€
WITHWHITE SP 18 X	BC/ST	BC	E27 2×77W E27		CE	ERC (EUC) (CCC)	DIM 1	550,00
WITHWHITE SP 18 P	BC/ST	BC	E27 2×77W E27		CE	ERC (EUC) (CCC)	DIM 1	540,00
WITHWHITE SP 18 M	BC/ST	BC	E27 2×77W E27		CE	ERC (EUC) (CCC)	DIM 1	520,00
WITHWHITE SP 18 G	BC/ST	BC	E27 2×77W E27		CE	ERC (EUC) (CCC)	DIM 1	540,00

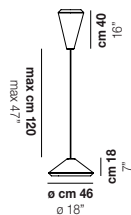

WITHWHITE SP 26 X

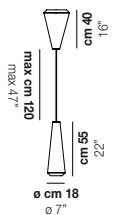

WITHWHITE SP 26 P

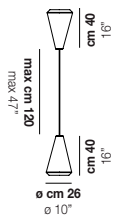

WITHWHITE SP 26 M

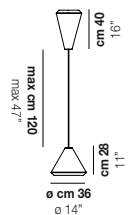

WITHWHITE SP 26 G

codice / code	vetro / glass	struttura / frame	elettrificazione / lamping	CL. IP	EU cert.	International cert.	dimmer	€
WITHWHITE SP 26 X	BC/ST	BC	E27 2×77W E27		CE	ERC (EUC) (CCC)	DIM 1	540,00
WITHWHITE SP 26 P	BC/ST	BC	E27 2×77W E27		CE	ERC (EUC) (CCC)	DIM 1	520,00
WITHWHITE SP 26 M	BC/ST	BC	E27 2×77W E27		CE	ERC (EUC) (CCC)	DIM 1	510,00
WITHWHITE SP 26 G	BC/ST	BC	E27 2×77W E27		CE	ERC (EUC) (CCC)	DIM 1	510,00

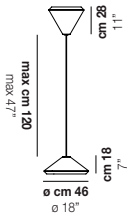

WITHWHITE SP 36 X

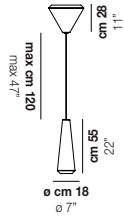

WITHWHITE SP 36 P

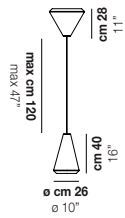

WITHWHITE SP 36 M



WITHWHITE SP 36 G

codice / code	vetro / glass	struttura / frame	elettrificazione / lamping	CL. IP	EU cert.	International cert.	dimmer	€
WITHWHITESP 36 X	BC/ST	BC	E27 2x77W E27		CE	ERAC	DIM 1	560,00
WITHWHITESP 36 P	BC/ST	BC	E27 2x77W E27		CE	ERAC	DIM 1	550,00
WITHWHITESP 36 M	BC/ST	BC	E27 2x77W E27		CE	ERAC	DIM 1	530,00
WITHWHITESP 36 G	BC/ST	BC	E27 2x77W E27		CE	ERAC	DIM 1	540,00



WITHWHITE SP 46 X

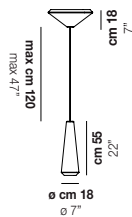

WITHWHITE SP 46 P

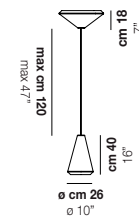

WITHWHITE SP 46 M

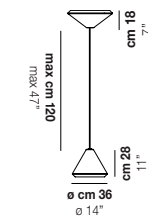

WITHWHITE SP 46 G

codice / code	vetro / glass	struttura / frame	elettrificazione / lamping	CL. IP	EU cert.	International cert.	dimmer	€
WITHWHITESP 46 X	BC/ST	BC	E27 3x77W E27		CE	ERAC	DIM 1	610,00
WITHWHITESP 46 P	BC/ST	BC	E27 3x77W E27		CE	ERAC	DIM 1	600,00
WITHWHITESP 46 M	BC/ST	BC	E27 3x77W E27		CE	ERAC	DIM 1	580,00
WITHWHITESP 46 G	BC/ST	BC	E27 3x77W E27		CE	ERAC	DIM 1	590,00

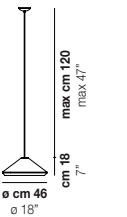

WITHWHITE SP X

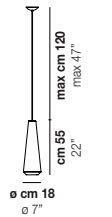

WITHWHITE SP P

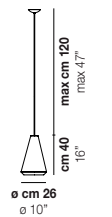

WITHWHITE SP M

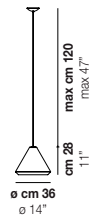

WITHWHITE SP G

codice / code	vetro / glass	struttura / frame	elettrificazione / lamping	CL. IP	EU cert.	International cert.	dimmer	€
WITHWHITESPX	BC/ST	BC	E27 1x77W E27		CE	ERAC	DIM 1	280,00
WITHWHITESPP	BC/ST	BC	E27 1x77W E27		CE	ERAC	DIM 1	265,00
WITHWHITESPM	BC/ST	BC	E27 1x77W E27		CE	ERAC	DIM 1	250,00
WITHWHITESPG	BC/ST	BC	E27 1x77W E27		CE	ERAC	DIM 1	260,00

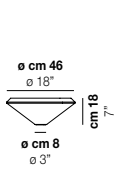

WITHWHITE PL 46

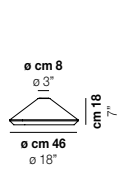

WITHWHITE PL X

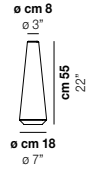

WITHWHITE PL P

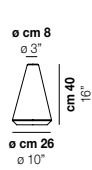

WITHWHITE PL M

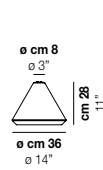

WITHWHITE PL G

codice / code	vetro / glass	struttura / frame	elettrificazione / lamping	CL. IP	EU cert.	International cert.	dimmer	€
WITHWHITE PL 46	BC/ST	BC	E27 2x100W E27	⚡ IP20	CE	EAC cULus CCC	DIM 1	310,00
WITHWHITE PL X	BC/ST	BC	E27 1x100W E27	⚡ IP20	CE	EAC cULus CCC	DIM 1	265,00
WITHWHITE PL P	BC/ST	BC	E27 1x100W E27	⚡ IP20	CE	EAC cULus CCC	DIM 1	250,00
WITHWHITE PL M	BC/ST	BC	E27 1x100W E27	⚡ IP20	CE	EAC cULus CCC	DIM 1	230,00
WITHWHITE PL G	BC/ST	BC	E27 1x100W E27	⚡ IP20	CE	EAC cULus CCC	DIM 1	245,00

Condizioni di vendita

- 1) Le seguenti condizioni di vendita sono generali. Le condizioni di vendita dettagliate e personalizzate sono pubblicate nel portale MyVistosi <http://www.vistosi.it/portal> www.vistosi.it/portal. Il Cliente potrà avervi accesso diretto anche dalle conferme d'ordine. Le condizioni personalizzate di base sono: sconto, modalità di pagamento, modalità di trasporto, fido e minimi d'ordine. Le condizioni di vendita saranno rinnovate ogni inizio d'anno. I Clienti che non acquisteranno alcun prodotto per un periodo superiore a 12 mesi saranno considerati inattivi e tutte le condizioni di vendita personalizzate non saranno più in vigore.
- 2) In caso di ordini di prodotti fuori listino, di prodotti a disegno o di prodotti con modifiche allo standard, Vetreria Vistosi Srl si riserva il diritto di formulare delle offerte con condizioni di vendita diverse da quelle accordate.
- 3) Per la merce non a magazzino, i tempi di consegna medi sono di 3-4 settimane. Le giacenze sono aggiornate quotidianamente nel portale MyVistosi.
- 4) Gli imballi sono severamente testati. Il Cliente è tenuto a controllare accuratamente la merce prima di consegnarla o di spedirla al Cliente finale. Non saranno accettati reclami per merce non presente nel luogo di destinazione indicato nei documenti di trasporto.
- 5) Eventuali danni da trasporto alla merce o all'imballo della merce, evidenti al momento della consegna, come pure differenze di quantità e/o di modello rispetto a quanto indicato nel documento di trasporto, devono essere segnalate con riserva specifica e dettagliata nella lettera di vettura del corriere.
- 6) Eventuali danni da trasporto alla merce, non evidenti al momento della consegna o non ragionevolmente presumibili al momento della consegna, devono essere segnalati entro 8 gg dalla consegna nella sezione reclami del portale MyVistosi.
- 7) Le lavorazioni completamente manuali, i complessi processi di fusione, la raffinatezza delle miscele chimiche dei vetri di Vistosi e tipiche delle antiche tecniche di lavorazione di Murano, possono dar luogo a leggere imprecisioni dei colori, nelle forme e nelle dimensioni, negli spessori e nei decori. Più che imperfezioni o difformità di qualità sono da considerarsi espressione del vetro lavorato a mano e soffiato a bocca. Piccole bolle irregolari, venature, piccoli puntini di materiale denso e altre imperfezioni devono quindi essere tollerate, in particolar modo nelle forme e nelle lavorazioni più complesse o nei modelli di medio-grandi dimensioni.
- 8) Vetreria Vistosi Srl si riserva il diritto di modificare in qualsiasi momento e senza preavviso qualsiasi modello. Il cliente che dovesse avere necessità specifiche o che dovesse abbinare i modelli ordinati ad altri già in suo possesso deve specificarlo nell'ordine.
- 9) Vetreria Vistosi Srl si riserva il diritto di togliere dalla produzione uno o più modelli senza darne preavviso. Il Cliente si impegna a segnalare tempestivamente qualsiasi progetto o quotazione da evadere per dare modo a Vistosi di tenerne conto nella scelta dei modelli da togliere dalla produzione.
- 10) Le disponibilità di magazzino e i tempi di consegna di ogni modello sono indicate e aggiornate quotidianamente nel portale MyVistosi.
- 11) Le aggiunte d'ordine che, per mancanza di disponibilità di magazzino, restassero inevase, verranno considerate come ordini a sé stanti.
- 12) Spedizioni parziali di ordini su sollecito del cliente, salvo ritardi di spedizione rispetto alla conferma d'ordine, verranno considerate come ordini a sé stanti.
- 13) Gli ordini saranno considerati accettati solo al momento dell'invio della conferma d'ordine via email all'indirizzo indicato dal Cliente e riportato nella scheda Cliente nel portale MyVistosi. Il Cliente si impegna a richiedere modifiche alle conferme d'ordine per qualsiasi ragione entro e non oltre 2 gg lavorativi dal ricevimento della conferma d'ordine. Trascorso questo termine gli ordini non saranno cancellabili o modificabili.
- 14) Tutti i modelli sono garantiti per un periodo di 2 anni dalla data del documento di vendita di Vetreria Vistosi Srl. La garanzia non copre errori di installazione, errori di uso e manutenzione del prodotto, rimozione della componentistica. Le istruzioni di montaggio sono parte integrante del prodotto.
- 15) L'imballo standard è compreso nel prezzo, i bancali non sono compresi nel prezzo.
- 16) Le lampadine non sono incluse nel prezzo.
- 17) Per ogni eventuale controversia di qualsiasi genere e sorta in qualsiasi luogo sarà competente il foro di Venezia e la legge applicabile sarà quella italiana.

Sales conditions

- 1) The following are General Conditions of Sale. The detailed and personalized conditions of sale are published in the MyVistosi portal www.vistosi.it/portal. The Customer may have direct access to them from the order confirmations, too. The basic customized conditions are: discount, payment methods, mode of transport, credit and minimum order. The conditions of sale will be renewed at the beginning of each year. The Customers that do not buy any product for a period longer than 12 months will be considered inactive and all conditions of sale will no longer be in force.
- 2) In the case of orders for products that are not listed in the price list, products that are based on drawings or products with modifications to the standard, Vetreria Vistosi Srl may reserve the right to make offers with different conditions of sale from those agreed.
- 3) For goods not in stock, the average delivery time is 3-4 weeks. Stocks are updated daily in the MyVistosi portal.
- 4) Packaging is severely tested. The Customer is required to check carefully the goods before delivering or shipping them to the final Customer. No claims will be accepted for goods not available at the place of destination that was indicated in the transport documents.
- 5) Any damage to goods in transit or to the packaging of goods, evident at the time of delivery, as well as differences in quantity and / or model compared to what is indicated in the transport document, must be reported as "goods unchecked" and that must be detailed in the waybill of the courier.
- 6) Any damage to goods in transit, not evident at the time of delivery or not reasonably foreseeable at the time of delivery, must be reported within 8 days from the delivery in the complaints section of the portal MyVistosi.
- 7) Manual processing, elaborate melting processes, the refinement of chemical mixtures of Vistosi glass, which are typical of the ancient processing techniques of Murano, may give rise to slight inaccuracies in colour, shape and size, thickness and decoration. They must be considered as the result of handmade and mouth-blown glass procession, rather than imperfections or differences in quality. Small irregular bubbles, veins, small dots of dense material and other imperfections must therefore be tolerated, especially in the most intricate shapes and processes or in medium-large models.
- 8) Vetreria Vistosi Srl may reserve the right to modify any model at any time and without notice. Should Customers have specific needs or combine the models ordered with others already in their possession, they must specify that in the order.
- 9) Vetreria Vistosi Srl may reserve the right to discontinue one or more models without notice. Customers agree to promptly report any project or quotation to be processed in order to allow Vistosi to take that into account at the time of choosing the models to be discontinued.
- 10) Stock availability and delivery times of each model are indicated and updated daily in the MyVistosi portal.
- 11) Additions to orders that, due to lack of stock availability, remain unfulfilled, will be considered as separate orders.
- 12) Partial shipments of orders on request of the Customer, except for delays in shipment with respect to the order confirmation, will be considered as separate orders.
- 13) Orders will be considered accepted only when the order confirmation is sent by email to the address indicated by the Customer and reported in the Customer data sheet in the MyVistosi portal. The Customer agrees to request changes to the order confirmations for any reason within and no later than 2 working days from receipt of the order confirmation. After this period, orders cannot be cancelled or modified.
- 14) All models are warranted for a period of 2 years from the date of the sales document of Vetreria Vistosi Srl. The warranty does not cover installation errors, errors in use and maintenance of the product, removal of components. The assembly instructions are an integral part of the product.
- 15) Standard packaging is included in the price, pallets are not included in the price.
- 16) Bulbs are not included in the price.
- 17) For any dispute of any kind and arising in any place, the Court of Venice will be competent and the Italian law shall be the only one applicable.

Edizione n° 1 - Aprile 2019
Listino L01 2019-1 Euro Temporary - rev. n° 4

© **Copyright - Vetreria Vistosi s.r.l.**

Proprietà artistica e letteraria
riservata in tutto il mondo.
È vietata la riproduzione, anche parziale,
dei testi e delle fotografie senza autorizzazione.



Vetreria Vistosi s.r.l.

Via Galileo Galilei, 9-9/A-11
31021 Mogliano Veneto - Treviso (Italy)

Tel +39 041 5903480 · +39 041 5900170
Fax +39 041 5900992 · +39 041 5904540
www.vistosi.it · vistosi@vistosi.it