

PIETER ADAMTM
LIGHTING & ACCESSORIES

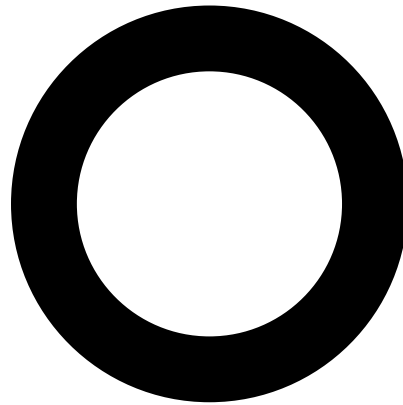

MADE OF MATERIALS LIKE BRASS,
MARBLE, GLASS, SILK AND LEATHER.
A STYLE FOR EVERY PERSON WHO
APPRECIATES A STYLISH AND
EXCLUSIVE DESIGN.

WWW.PIETER-ADAM.COM

WHAT YOU SEE IS WHAT YOU GET



PHILOSOPHY

Drawing from years of experience in exclusive lighting, Pieter Adam started his line of lighting as an alternative to the volatile, temporary and trendy mass production items available everywhere. His main focus was on quality and exclusivity with durability, craftsmanship and expertise being high on his priority list.

With a clean slate and full of ideas we began the Pieter Adam Collection with the key words contemporary, exclusive and stylish serving as the main design focus. Every detail and every piece was carefully thought out leaving nothing to chance.

Quality through expertise. Our many years of experience with bronze founders, glass blowers, granite refiners, and silk weavers enables our highly skilled craftsmen to make special limited edition pieces. As a result, we are able to meet special needs and requests, such as complete custom designed lighting plans for special projects.

Perfection is paramount in the Pieter Adam collection. From the silk chords to the metal housing for each fitting, a Pieter Adam piece is assembled with scrutiny and passion. A showpiece in your interior radiating international splendour.

A handwritten signature in black ink, consisting of a stylized 'P' followed by the name 'PIETER ADAM' in a cursive script.

PIETER ADAM





ROSEDALE

A real Pieter Adam piece plays with different materials. The elegance and lightness of the blown glass contradict the shape of the metal which gives a Rosedale piece its distinctive and playful quality thus ensuring its own identity and recognition. The glass beautifully absorbs any colour and the combination of materials engages the light in a very unique way.

The Rosedale series encompasses transparency and exclusivity offering plenty possibilities when you need a real glamour piece. Whether placed in a five-star hotel lobby or in your residence, these eye catchers complement any interior.

Timeless and with a great adaptability, a Rosedale piece easily integrates in its environment while leaving a great impression through its stylish appearance.

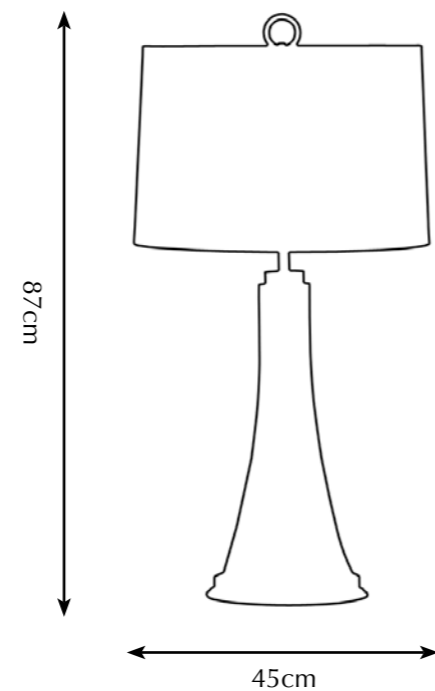

Itemnr: **PA 821**
Model: Rosedale table-lamp
Material: Casted brass/Blown Glass
Shade: 8214 Saffron Black
Sockets: 2x E27 max. 60 Watt
Finishes: -Dutch Silver
 -Canadian Gold
 -Smoked Brass

* For images of the other finishes visit our website.

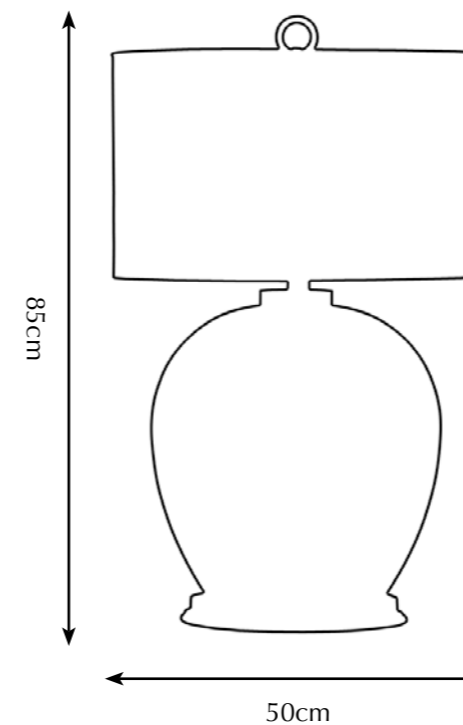

Itemnr: **PA 822**
Model: Rosedale table-lamp big
Material: Casted brass/Blown Glass
Shade: 5305 Pitch Black Silk
Sockets: 2x E27 max. 60 Watt
Finishes: -Dutch Silver
 -Canadian Gold
 -Smoked Brass
 -Rose Gold

* For images of the other finishes visit our website.



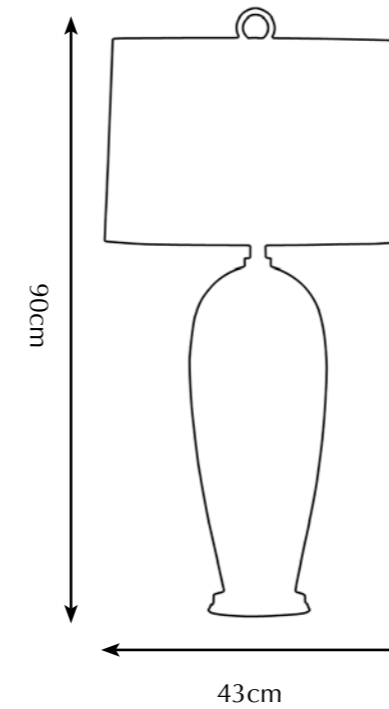

Itemnr: **PA 823**
Model: Rosedale table-lamp
Material: Casted brass/Blown Glass
Shade: 5301 Stony Ground Linen
Sockets: 2x E27 max. 60 Watt
Finishes: **-Dutch Silver**
 -Canadian Gold
 -Smoked Brass
 -Rose Gold

* For images of the other finishes visit our website.



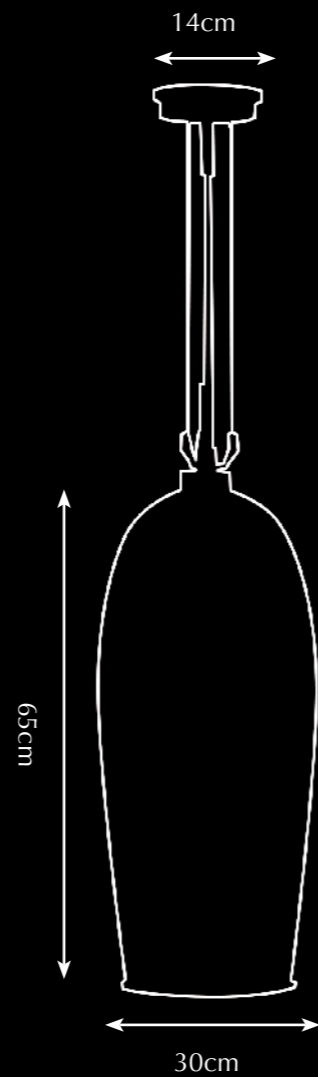

Itemnr: **PA 825**
 Model: Rosedale hanging lamp long
 Material: Casted brass/Blown glass
 Socket: E27 max. 60Watt
 Finishes: **-Dutch Silver**
 -Canadian Gold
 -Rose Gold

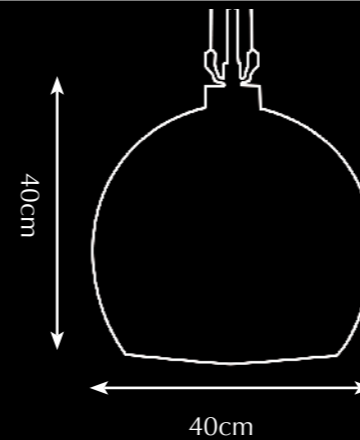

Itemnr: **PA 824**
 Model: Rosedale hanging lamp round
 Material: Casted brass/Blown glass
 Socket: E27 max. 60Watt
 Finishes: -Dutch Silver
-Canadian Gold
 -Rose Gold

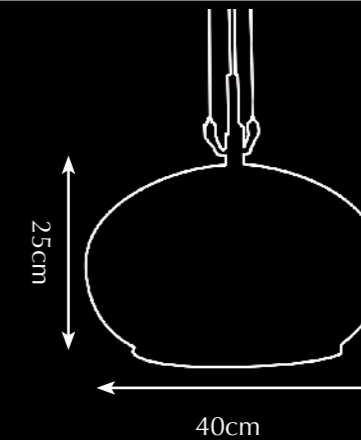

Itemnr: **PA 826**
 Model: Rosedale hanging lamp oval
 Material: Casted brass/Blown glass
 Socket: E27 max. 60Watt
 Finishes: -Dutch Silver
 -Canadian Gold
-Rose Gold



BRONX

The Bronx series exemplifies lighting with an international radiance. The Pieter Adam logo, circular interconnecting links, returns frequently within these series. These rings are very recognizable and give this series its own identity.

Inspiration for this series was found in refined traditional workmanship on the one hand and the dynamic development of the new era on the other resulting in an unpretentious design employing geometrical patterns and clean lines.

The Bronx style resembles the Art Deco looks. In the late 19th and early 20th century, the Art Deco workmanship was highly valued and appreciated. Also for this series, a lot of patience and expertise is demanded from our bronze founders. A laborious process, recurring in for example the separate moulding of each ring, which is subsequently melted onto the connecting piece. Polished, silver/gold plated and varnished, each piece is made with the utmost attention to perfection.

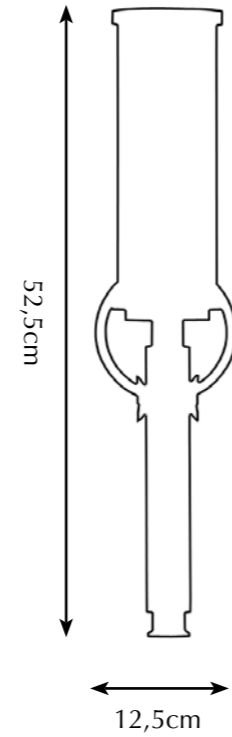

Itemnr: **PA 801**
Model: Bronx wall-sconce
Material: Casted brass
Sockets: E27 max. 60 Watt
Finishes: **-Dutch Silver**
-Canadian Gold
-Smoked Brass
-Retro Blond

* For images of the other finishes visit our website.

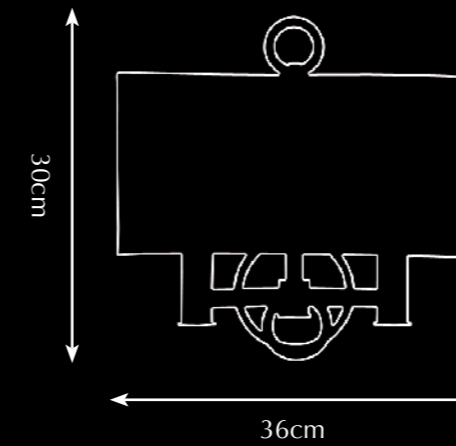

Itemnr: **PA 802**
Model: Bronx wall-sconce
Material: Casted brass
Shade: 8214 Saffron Black
Sockets: 2x E14 max. 60 Watt
Finishes: **-Dutch Silver**
-Canadian Gold
-Smoked Brass
-Retro Blond

* For images of the other finishes visit our website.



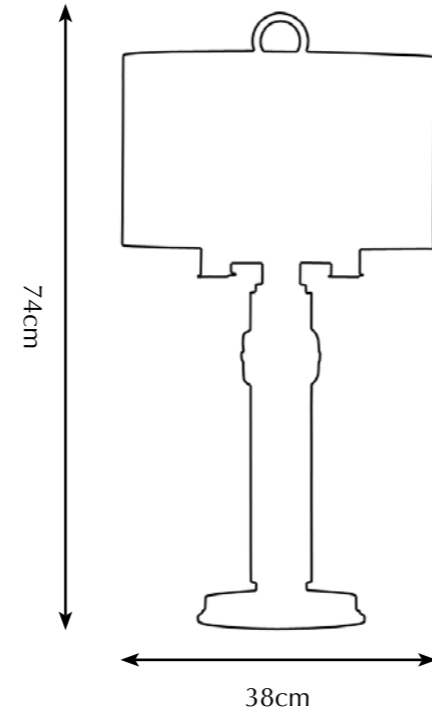

Itemnr: **PA 809**
Model: Bronx table-lamp
Material: Casted brass
Shade: D186 Black Gold Silk
Sockets: 4x E14 max. 40 Watt
Finishes: -Dutch Silver
 -Canadian Gold
 -Smoked Brass
 -Retro Blond

* For images of the other finishes visit our website.

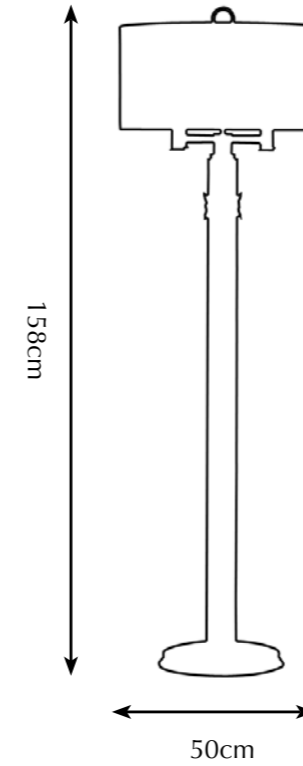

Itemnr: **PA 804**
Model: Bronx floor-lamp
Material: Casted brass
Shade: 5301 Stony Ground Linen
Sockets: 4x E14 max. 40 Watt
Finishes: **-Dutch Silver**
 -Canadian Gold
 -Smoked Brass
 -Retro Blond

* For images of the other finishes visit our website.



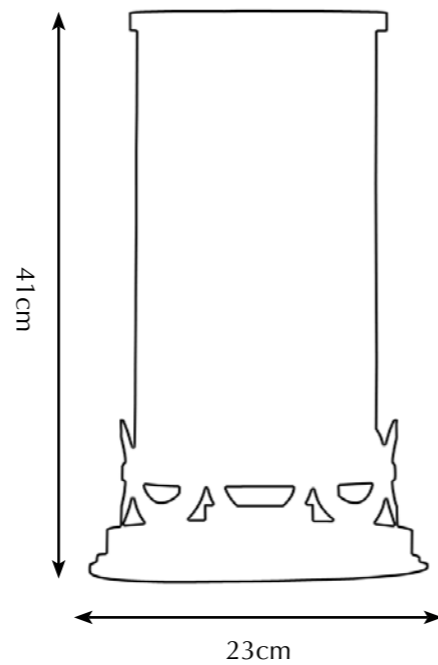

Itemnr: **PA 803**
Model: Bronx hurricane
Material: Casted brass
Finishes: **-Dutch Silver**
 -Canadian Gold
 -Smoked Brass
 -Retro Blond

* For images of the other finishes visit our website.



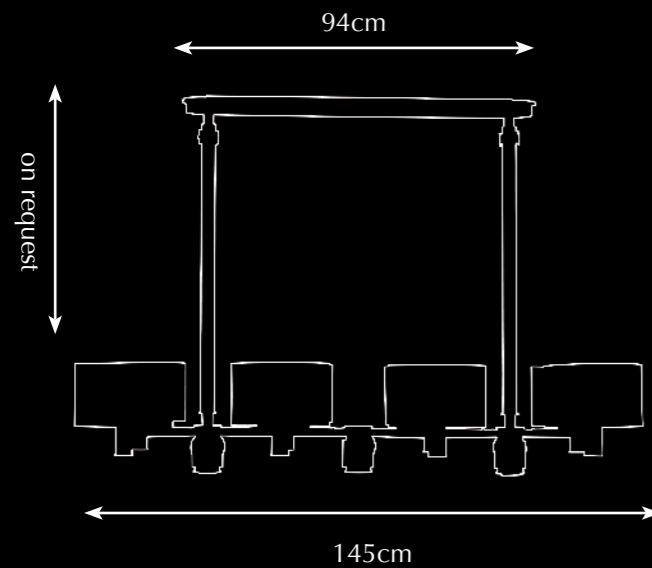

Itemnr: **PA 830**
 Model: Pendant Bronx 8 shades
 Material: Casted Brass
 Shade: 5301 Stony Ground Linen
 Sockets: 8x E27 max. 60 Watt,
 2x GU 10 220V halogen
 spotlight max. 50 Watt
 Finishes: **-Dutch Silver**
 -Canadian Gold
 -Smoked Brass
 -Retro Blond
 -Rose Gold

* For images of the other finishes visit our website.

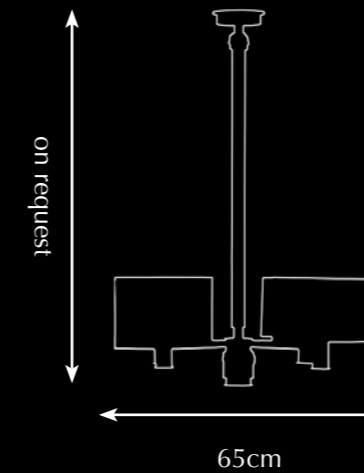

Itemnr: **PA 831**
 Model: Pendant Bronx 4 shades
 Material: Casted Brass
 Shade: 8273 Cracked Glossy Black
 Sockets: 4x E27 max. 60 Watt,
 1x GU 10 220V halogen
 spotlight max. 50 Watt
 Finishes: **-Dutch Silver**
-Canadian Gold
 -Smoked Brass
 -Retro Blond
 -Rose Gold

* For images of the other finishes visit our website.



ODEON

The Odeon collection uses the elegant diabolo shape as its starting point. The stacking and flared shape of this series gives it a sharp appearance with a hint of retro. The Pieter Adam rings also return here as an important decorative element as well as a trademark. With its strong contour, an Odeon piece represents sophisticated, refined and characteristic design without too much adornment.

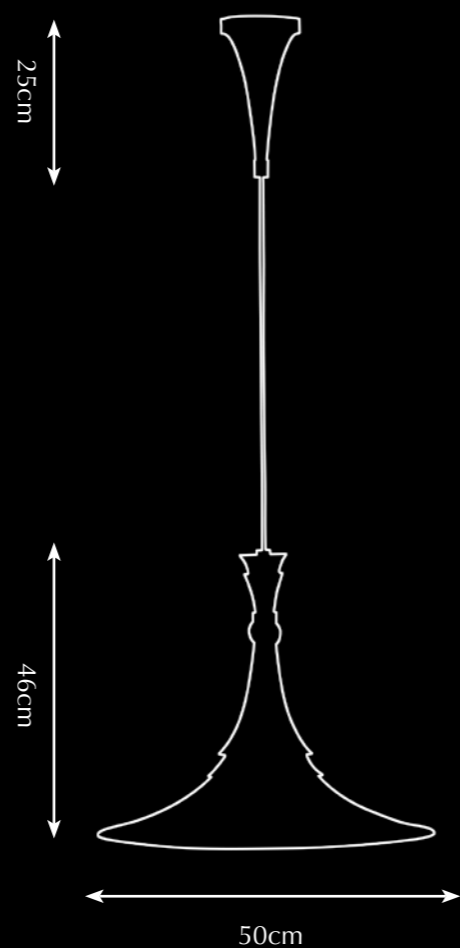

Itemnr: **PA 812**
Model: Odeon hanging-lamp
Material: Casted brass
Sockets: E27 max. 100 Watt
Finishes: **-Canadian Gold**
-Smoked Brass
-Retro Blond
-Dutch Silver

* For images of the other finishes visit our website.

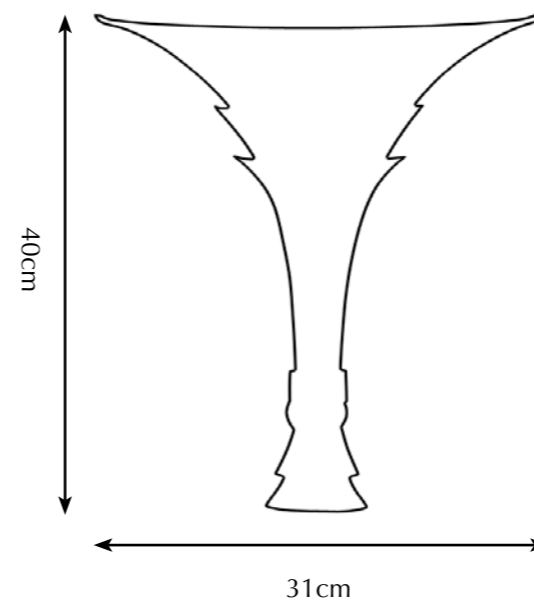

Itemnr: **PA 814**
Model: Odeon wall-sconce
Material: Casted brass
Sockets: E14 max. 100 Watt
Finishes: **-Dutch Silver**
-Canadian Gold
-Smoked Brass
-Retro Blond

* For images of the other finishes visit our website.



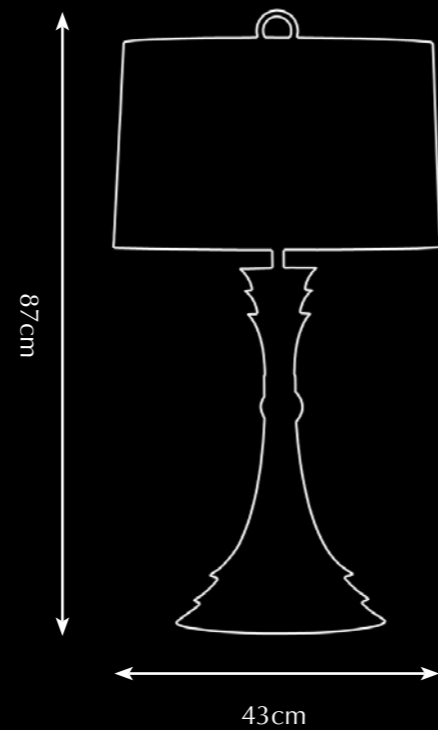

Itemnr: **PA 815**
Model: Odeon table-lamp
Material: Casted brass
Shade: D274 Pure Linen
Sockets: 2x E27 max. 60 Watt
Finishes: -Dutch Silver
-Canadian Gold
-Smoked Brass
-Retro Blond

* For images of the other finishes visit our website.

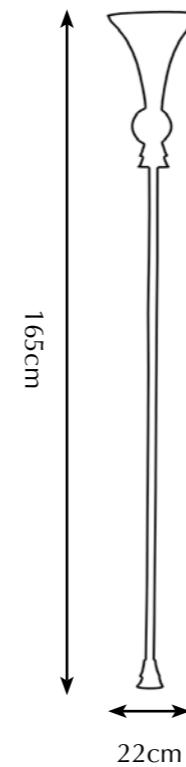

Itemnr: **PA 816**
Model: Odeon wall torch
Material: Casted brass
Sockets: E14 max. 40 Watt
Finishes: **-Dutch Silver**
-Canadian Gold
-Smoked Brass

* For images of the other finishes visit our website.



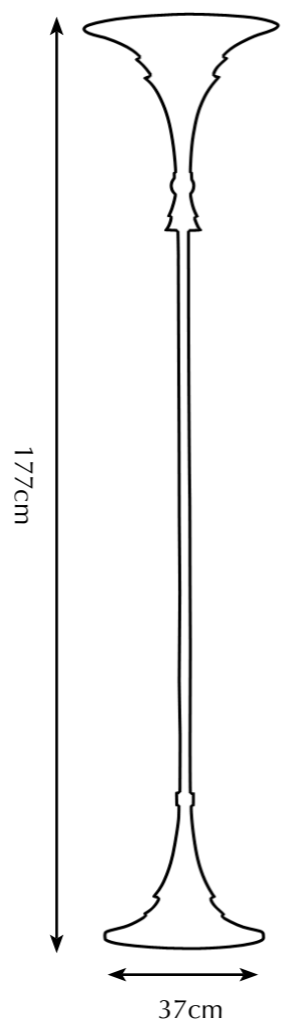
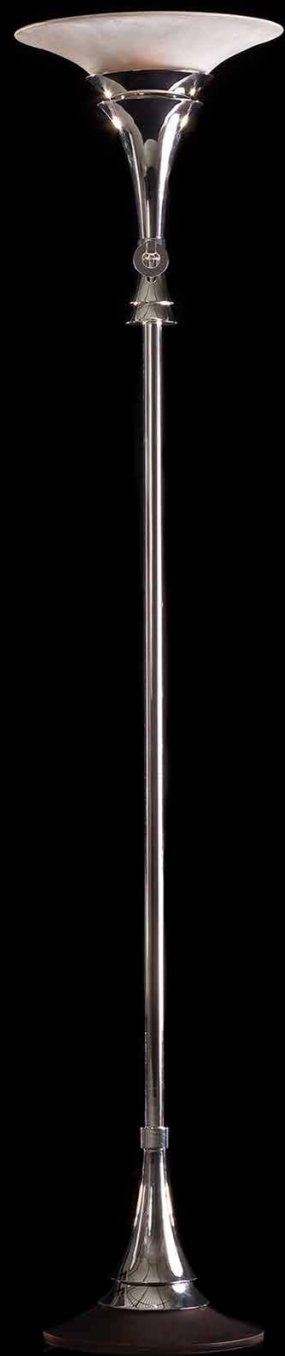

Itemnr: **PA 817**
Model: Odeon floor-lamp
Material: Casted brass
Sockets: E27 max. 100 Watt
Finishes: **-Dutch Silver**
-Canadian Gold
-Retro Blond

* For images of the other finishes visit our website.

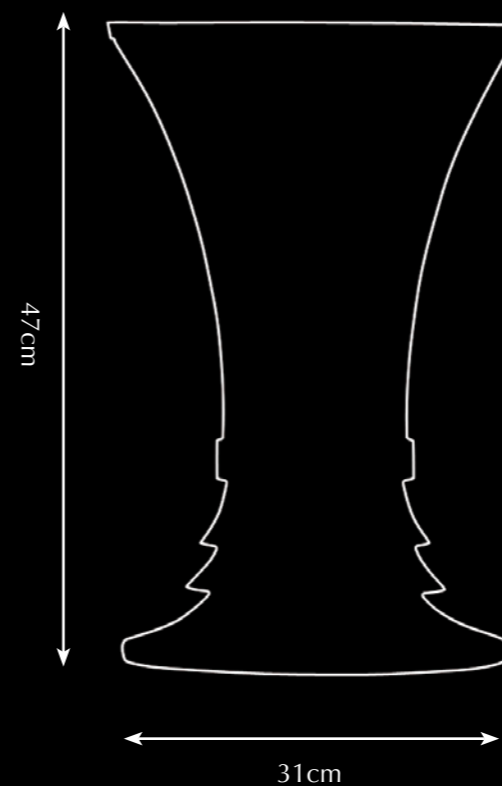

Itemnr: **PA 818**
Model: Odeon hurricane
Material: Casted brass
Finishes: **-Canadian Gold**
-Smoked Brass
-Retro Blond

* For images of the other finishes visit our website.







MELTING PARIS

The Melting Paris series combines nature's radiance with organic shapes in a contemporary style by employing a raw surface of bronze. Recognizable shapes are restyled to achieve their own look.

In contrast with today's mass production, Pieter Adam wants his designs to show his personal touch and signature. This is clearly visible in the Melting Paris series where each piece is handcrafted in wax literally showing the artist's finger prints. When looking at a Melting piece one can see the organic, unrestricted shape; nothing is straight or smooth. These pieces are characteristic of detail and achievement. The possibilities bronze casting offers are being employed in all its facets.

The freedom of creativity and inspiration is ultimately found in creating something by just using your hands. It is the purest way of designing. Away from all mass produced items and searching for the authentic craftsmanship only traditional craftsmen can achieve. Sustainable, with love for his craft and the end product, a Melting Paris piece truly gives a peek in the artist's head.

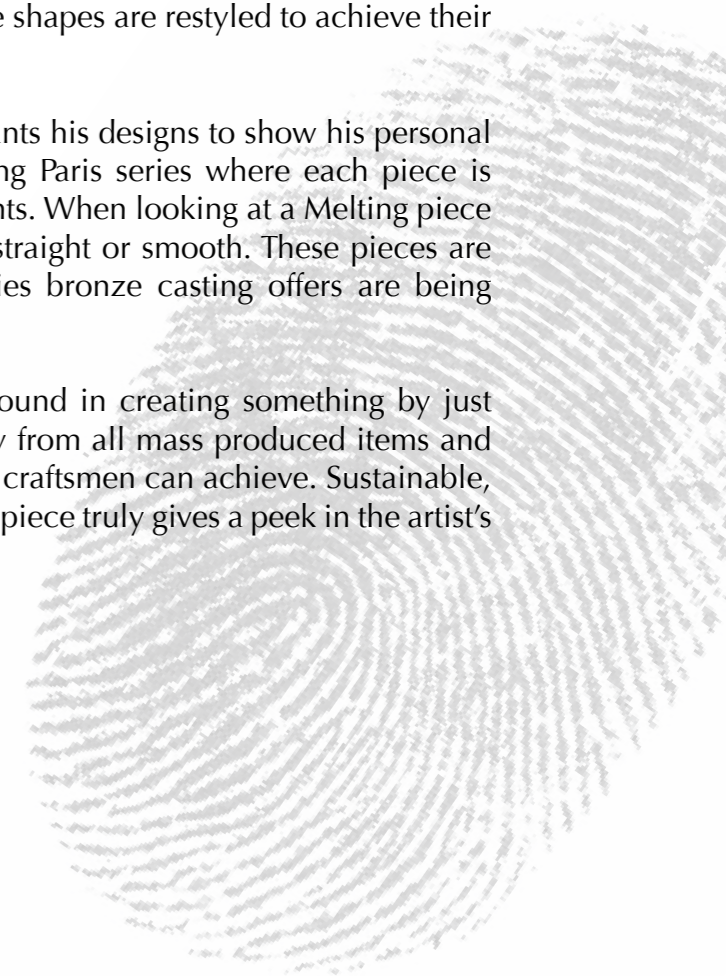

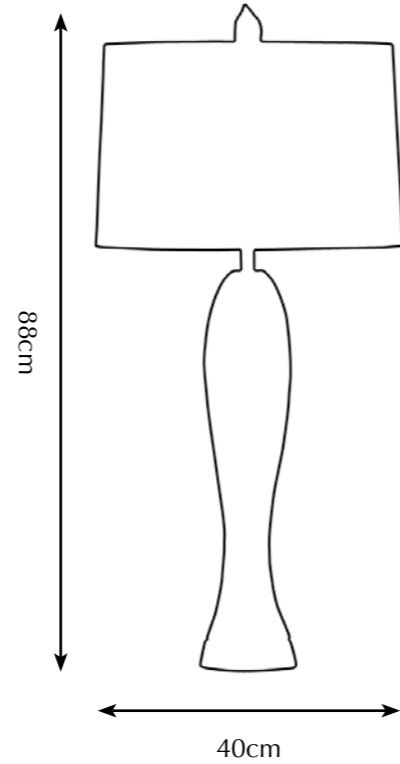

Itemnr: **PA 847**
Model: Melting Paris table-lamp
Material: Casted brass
Shade: 5300 Forest Linen
Sockets: 2x E27 max. 60 Watt
Finishes: -Dutch Silver
-Canadian Gold
-Smoked Brass
-Rose Gold

* For images of the other finishes visit our website.

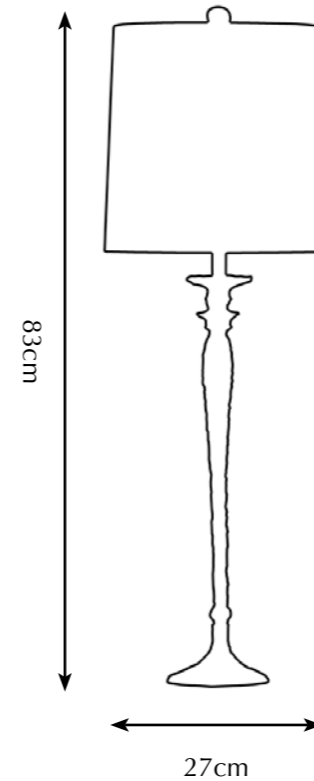

Itemnr: **PA 849**
Model: Melting Paris table-lamp
Material: Casted brass
Shade: 8259 Ivory Velvet
Sockets: 2x E14 max. 40 Watt
Finishes: **-Dutch Silver**
-Canadian Gold
-Smoked Brass
-Rose Gold

* For images of the other finishes visit our website.



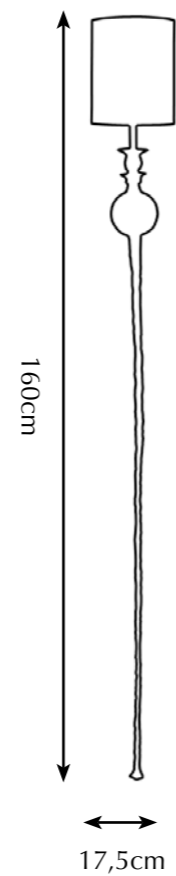

Itemnr: **PA 856**
Model: Melting Paris wall-torch long
Material: Casted brass
Shade: 7051 Seashell Silk
Sockets: E27 max. 60 Watt
Finishes: -Dutch Silver
 -Canadian Gold
 -Smoked Brass
 -Rose Gold

* For images of the other finishes visit our website.

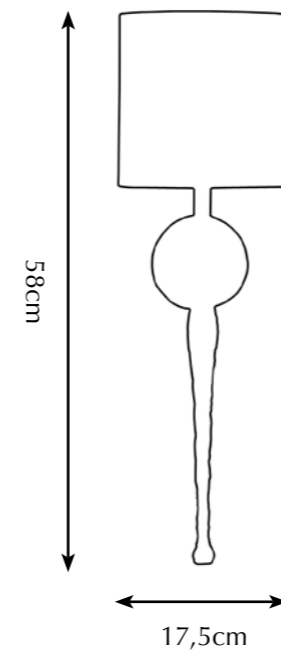

Itemnr: **PA 855**
Model: Melting Paris wall-torch
Material: Casted brass
Shade: 5301 Stony ground Linen
Sockets: E27 max. 40 Watt
Finishes: **-Dutch Silver**
 -Canadian Gold
 -Smoked Brass
 -Rose Gold

* For images of the other finishes visit our website.



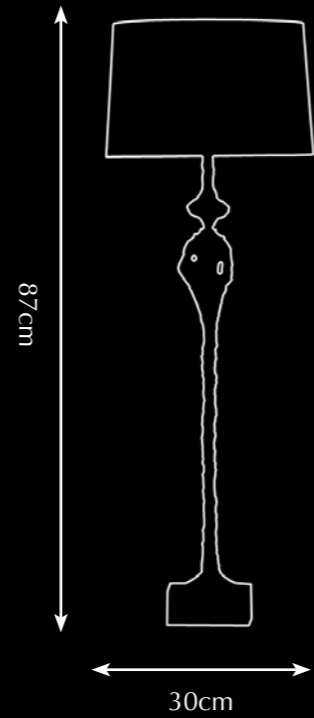

Itemnr: **PA 851**
Model: Melting Paris Sunday afternoon man
Material: Casted brass
Shade: 8261 Burnished Gold Velvet
Sockets: 2x E14 max. 40 Watt
Finishes: -Dutch Silver
 -Canadian Gold
 -Smoked Brass

* For images of the other finishes visit our website.

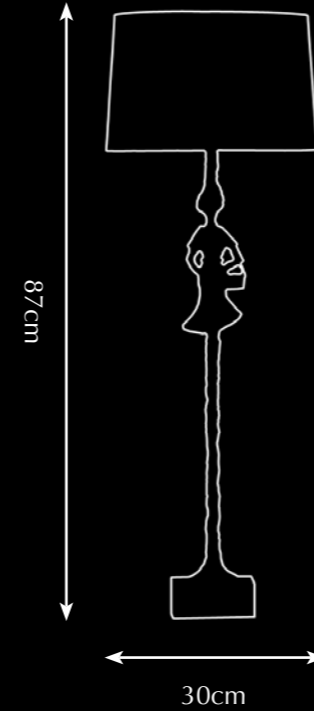

Itemnr: **PA 850**
Model: Melting Paris Sunday afternoon woman
Material: Casted brass
Shade: 8261 Burnished Gold Velvet
Sockets: 2x E14 max. 40 Watt
Finishes: -Dutch Silver
 -Canadian Gold
 -Smoked Brass

* For images of the other finishes visit our website.



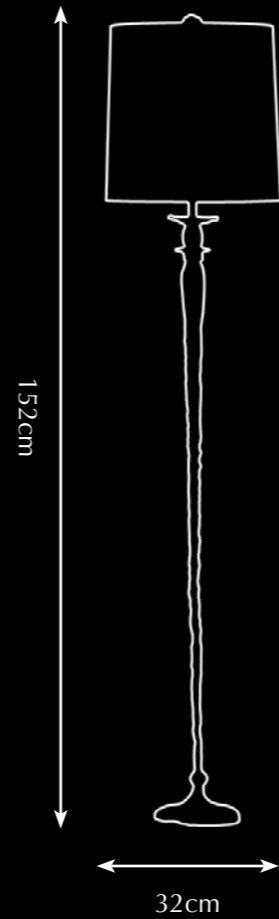

Itemnr: **PA 845**
Model: Melting Paris floor-lamp
Material: Casted brass
Shade: 8230 Black Leather
Sockets: 2x E14 max. 40 Watt
Finishes: -Dutch Silver
-Canadian Gold
-Smoked Brass
-Rose Gold

* For images of the other finishes visit our website.





MELTING AMSTERDAM

Our capital Amsterdam has a rich history and has been a cultural melting pot for many centuries. As a result, the city has its own identity with freedom and individuality being its main traits. This is also true of the new collection designed by Pieter Adam™. The copper-tinted chandeliers of the Golden Age were a source of inspiration for this unique line of lighting fixtures. Tradition and craftsmanship are applied in a contemporary way bringing the past, present and future together. Materials such as gold, silver, Murano glass, silk and brass casted in sand are used for their superior quality. The Dutch design of Pieter Adam™ supplies the originality.

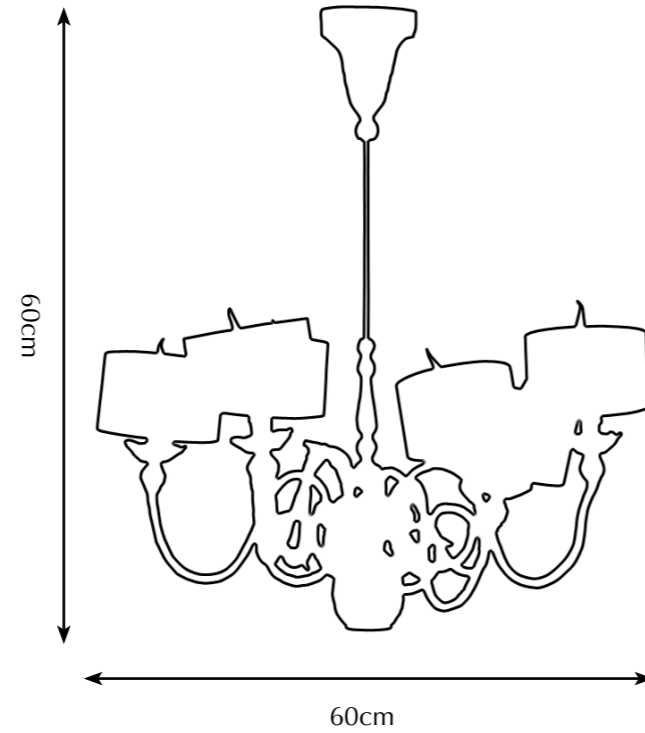

Itemnr: **PA 860**
Model: Melting Amsterdam chandelier
Material: Casted brass
Shade: 8259 Ivory Velvet
Sockets: G4 12V max. 10 Watt halogen,
Spotlight max. 30 Watt
Finishes: **-Dutch Silver**
-Canadian Gold

* For images of the other finishes visit our website.

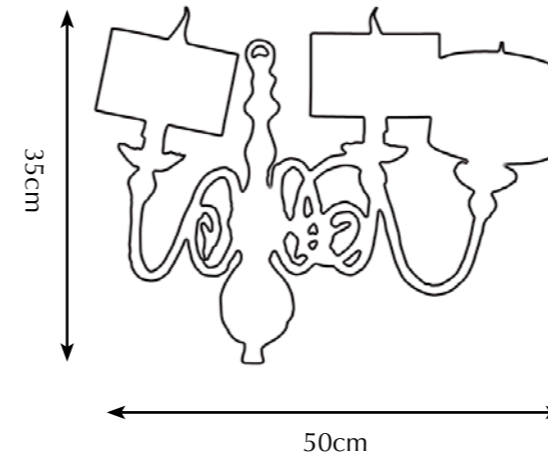

Itemnr: **PA 861**
Model: Melting Amsterdam wall sconce
Material: Casted brass
Shade: 5305 Pitch Black Silk
Sockets: G4 12V max. 10 Watt halogen
Finishes: **-Dutch Silver**
-Canadian Gold

* For images of the other finishes visit our website.



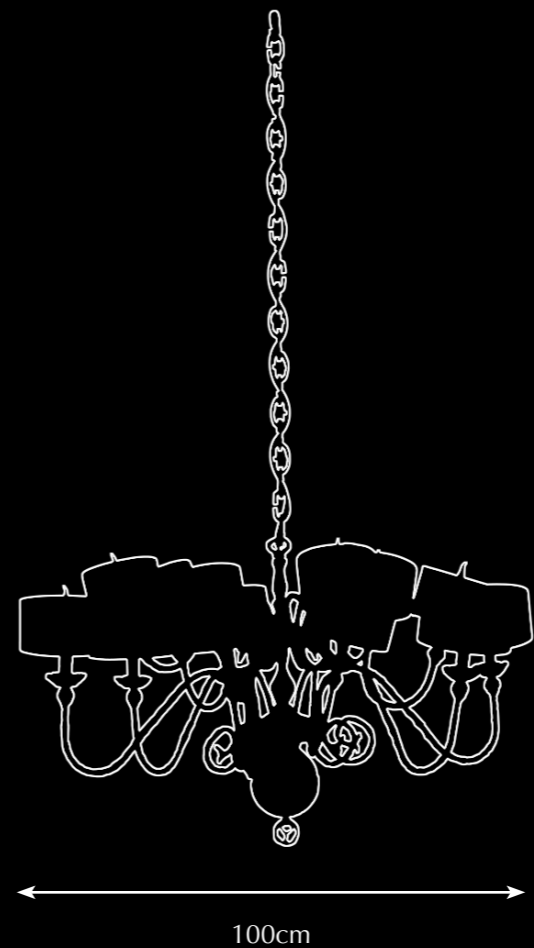

Itemnr: **PA 865**
Model: Melting Amsterdam chandelier XL
Material: Casted brass
Shade: 8259 Ivory Velvet
Sockets: 12x G9 230V max. 25Watt
Finishes: **-Dutch Silver**
 -Canadian Gold
 -Rose Gold

* For images of the other finishes visit our website.

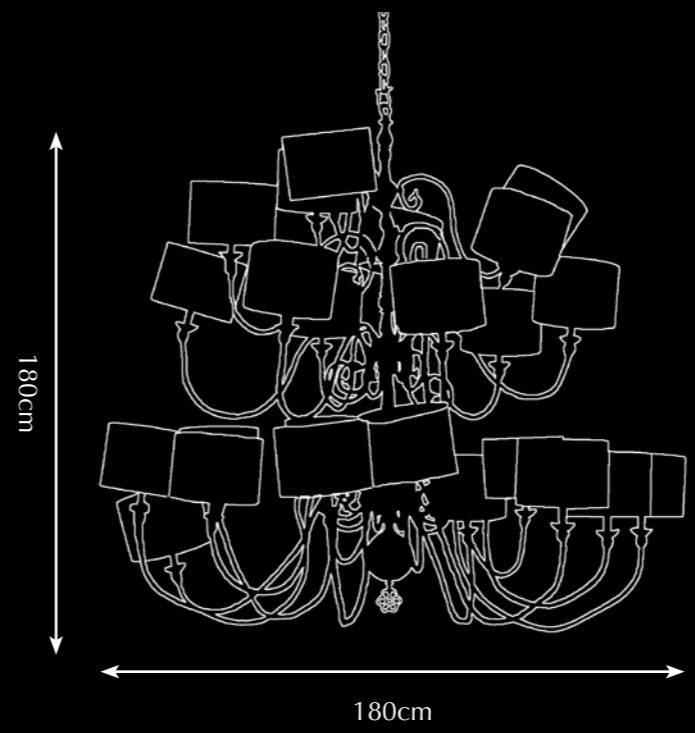

Itemnr: **PA 866**
Model: Melting Amsterdam hanging lamp XXL
Material: Casted Brass
Shades: on request
Sockets: 24x E27 max. 60 Watt
Finishes: **-Dutch Silver**
 -Canadian Gold

* For images of the other finishes visit our website.



TWIGGY

Pieter Adam's Twiggy line comprehends contemporary design and sustainability. Twiggy is a collection based on nature's purest grace. Inspiration was found in the organic, capricious shaping of twigs. Pursuing nature's strength in growing strong and solid with its unequalled, beautiful and characteristic appearance was serving as the main source of inspiration for the designer. Fair materials like brass and glass emphasize the sustainable nature of this collection. Organic shapes casted in brass and crafted with the utmost attention to detail combined with mouthblown glass providing a subtle reflection of the halogen light. Finishes like silver and gold give this lighting series its specific and exclusive radiation.

Look, feel and admire: enjoy nature's beauty where no twigs are alike.

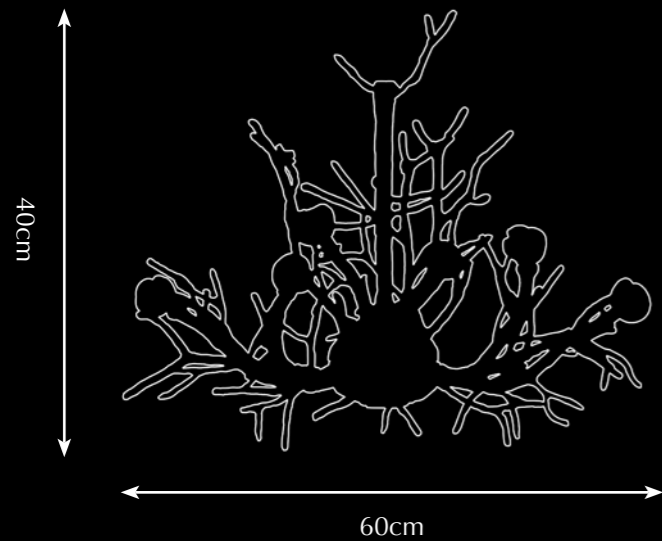

Itemnr: **PA 870**
 Model: Twiggy hanging lamp small
 Material: Casted brass
 Sockets: 6x G4 12V max. 5 Watt
 halogen spot max. 30 Watt
 Finishes: -Dutch Silver
-Canadian Gold
 -Smoked Brass

* For images of the other finishes visit our website.

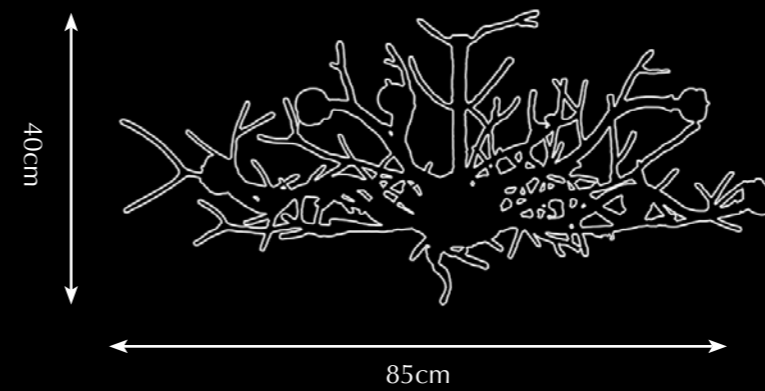

Itemnr: **PA 871**
 Model: Twiggy hanging lamp medium
 Material: Casted brass
 Sockets: 9x G4 12V max. 5 Watt
 halogen spot max. 30 Watt
 Finishes: **-Dutch Silver**
 -Canadian Gold
 -Smoked Brass

* For images of the other finishes visit our website.

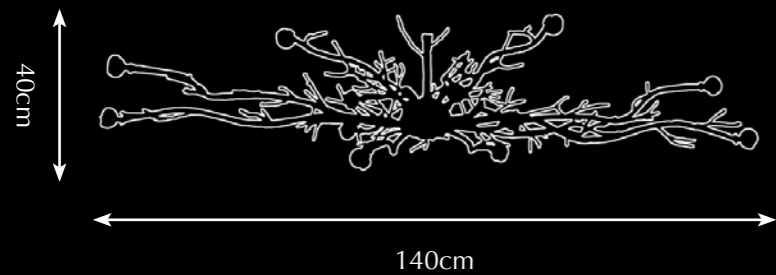

Itemnr: **PA 872**
 Model: Twiggy hanging lamp large
 Material: Casted brass
 Sockets: 12x G4 12V max. 5 Watt
 halogen spot max. 30 Watt
 Finishes: **-Dutch Silver**
 -Canadian Gold
 -Smoked Brass

* For images of the other finishes visit our website.

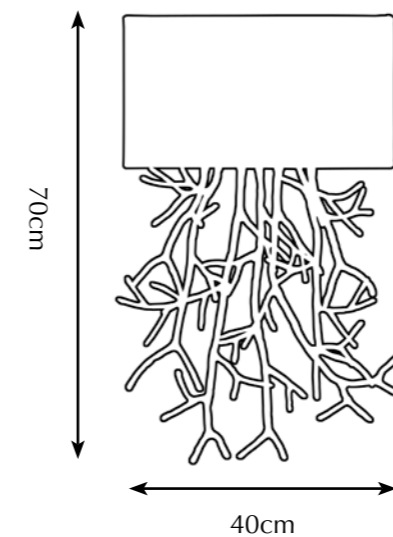
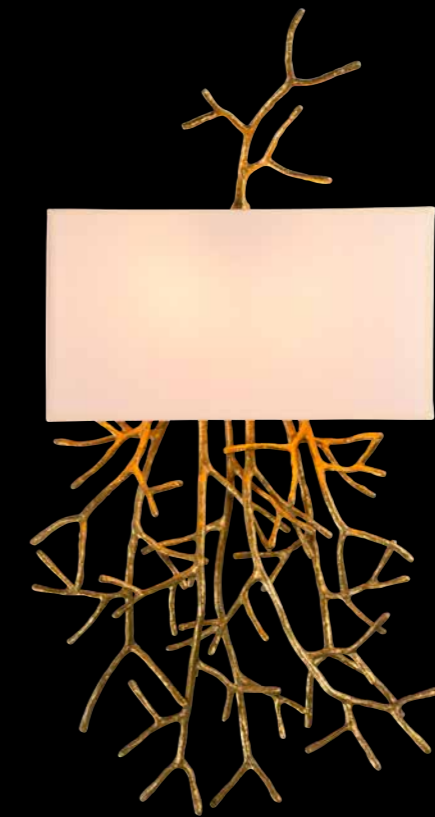

Itemnr: **PA 875**
 Model: Twiggy wall-sconce
 Material: Casted brass
 Shade: 8111 Champagne Silk
 Sockets: 2x E14 max. 40Watt
 Finishes: **-Dutch Silver**
-Canadian Gold
 -Smoked Brass

* For images of the other finishes visit our website.

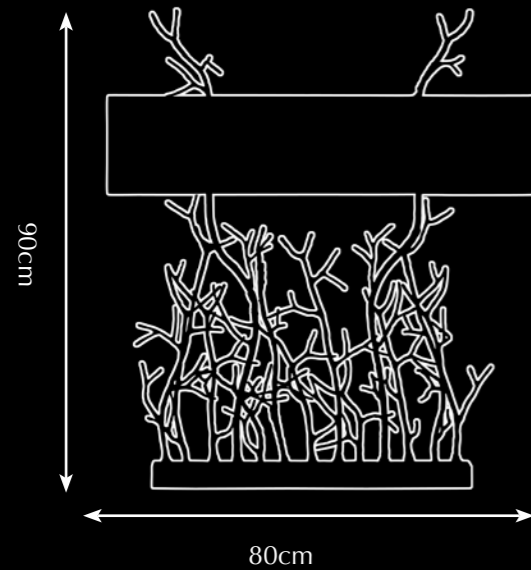
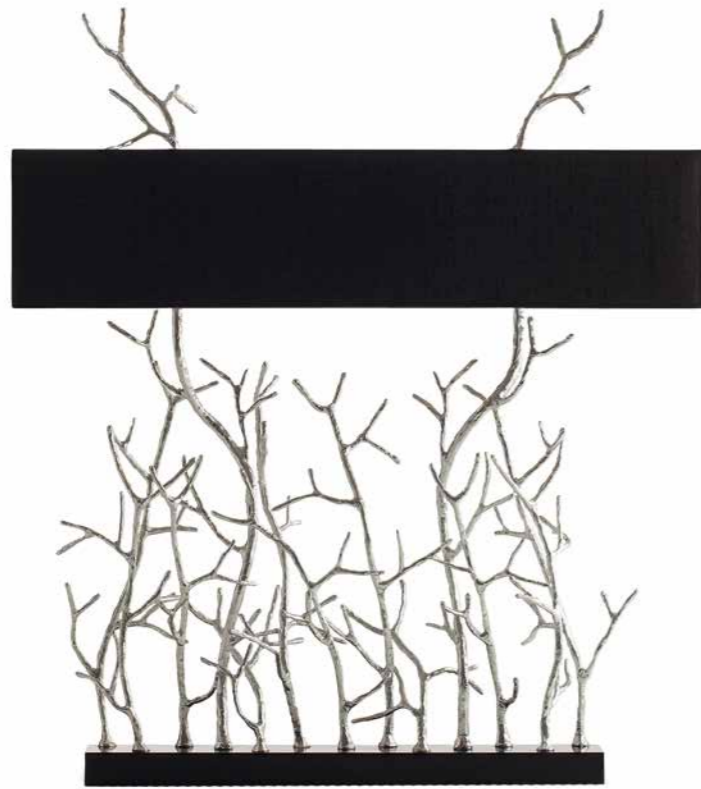

Itemnr: **PA 873**
 Model: Twiggy table lamp XL
 Material: Casted brass
 Shade: 5306 Pitch Black Silk
 Sockets: 4x E14 max. 40 Watt
 Finish: **-Dutch Silver**
 -Canadian Gold
 -Smoked Brass

* For images of the other finishes visit our website.

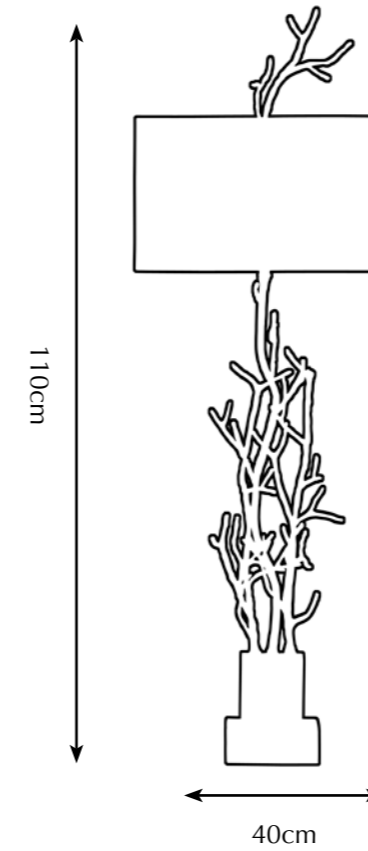

Itemnr: **PA 874**
 Model: Twiggy table lamp high
 Material: Casted brass
 Shade: 8215 Ivory Smooth Linen
 Sockets: 2x E14 max. 40 Watt
 Finish: **-Dutch Silver**
 -Canadian Gold
 -Smoked Brass

* For images of the other finishes visit our website.



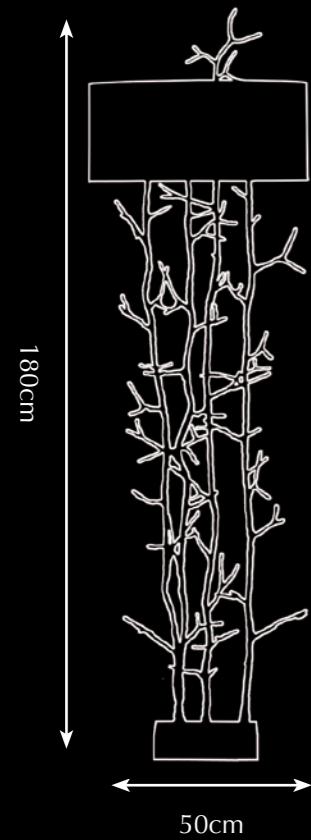

Itemnr: **PA 876**
 Model: Twiggy floor lamp
 Material: Casted brass
 Shade: 5305 Pitch Black Silk
 Sockets: 2x E14 max. 40Watt
 Finish: -Dutch Silver
 -Canadian Gold
 -Smoked Brass

* For images of the other finishes visit our website.

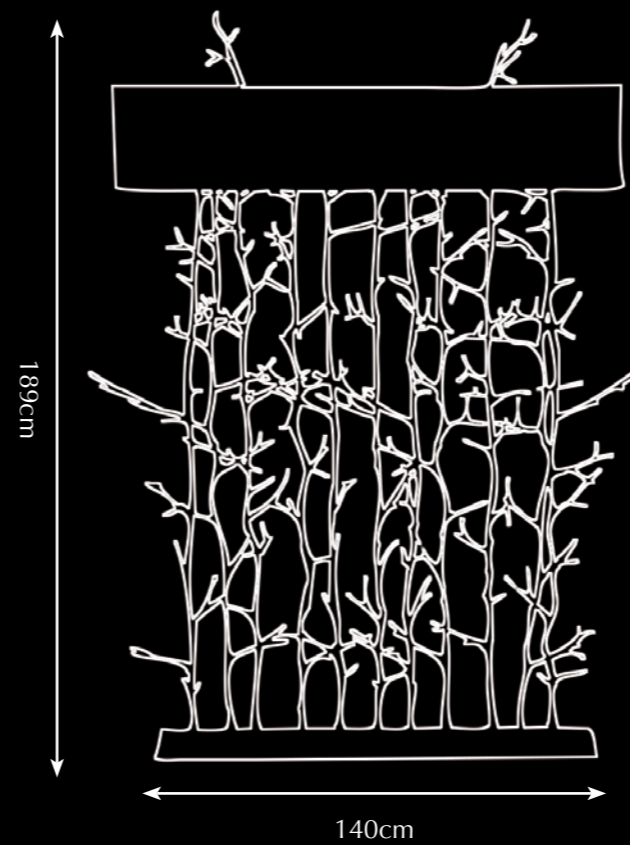
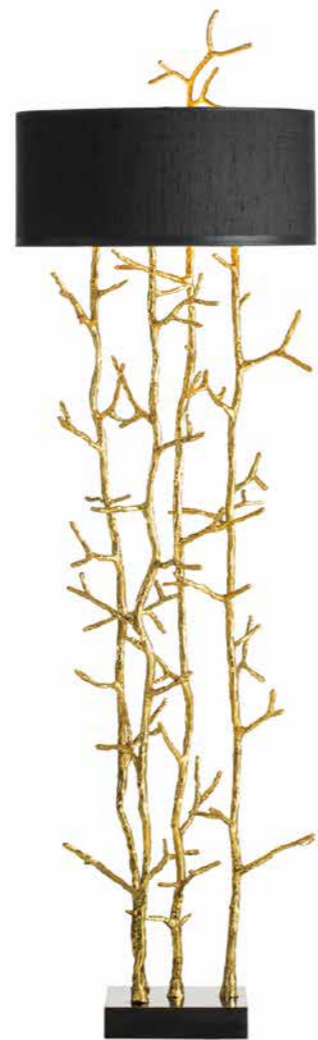

Itemnr: **PA 877**
 Model: Twiggy floor lamp XL
 Material: Casted Brass
 Shades: 8111 Champagne Silk
 Sockets: 4x E14 max. 40Watt
 Finishes: -Dutch Silver
 -Canadian Gold
 -Smoked Brass

* For images of the other finishes visit our website.





LE SOLEIL

Pieter Adam's Le Soleil design encompasses the shape and warm shine of a radiant sun. Nature's beauty has always been a main source of inspiration for the Pieter Adam collection and this was no different for the Le Soleil design. A natural shape made of bronze, with a closed inner circle and an outer circle scattering rays of light. This sculpture has a very pleasant and warm appearance. It can be adjusted to the wall, as well as to the ceiling, ensuring an unique diffusion of light. Le Soleil is available in four sizes and in the finishes bronze, silver and gold. Contemporary and subtle design are characteristic for the Pieter Adam collection and for this, Le Soleil is no exception.

PIETER ADAM

CONTEMPORARY DESIGN

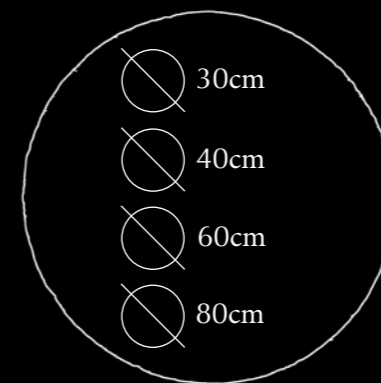

Itemnr: **PA 200 - 30cm**
PA 201 - 40cm
PA 202 - 60cm
PA 203 - 80cm
Model: Le Soleil wall lamp
Material: Casted brass
Sockets: 6x max. 10 Watt G4
Finishes: -Vintage Silver
-Vintage Gold
-Smoked brass

* For images of the other finishes visit our website.



ORGANIC ATOMIC

As its name indicates, the design of Organic Atomic is reminiscent of the smallest particle that an element can be reduced to. This lighting object resembles the organic both systematic composition of everything we see around us. Based on the organic work of art, the spheres are connected in a way that the whole forms an impressive and striking piece of lighting. The Murano glasses with silver leaf are specially blown and designed for this new Pieter Adam series. Sculpted by hand and casted in brass, the connecting pieces can be linked in many ways providing endless possibilities for customization. This leaves lighting architects the opportunity to give their own interpretation to this design and fit it perfectly into their lighting projects.

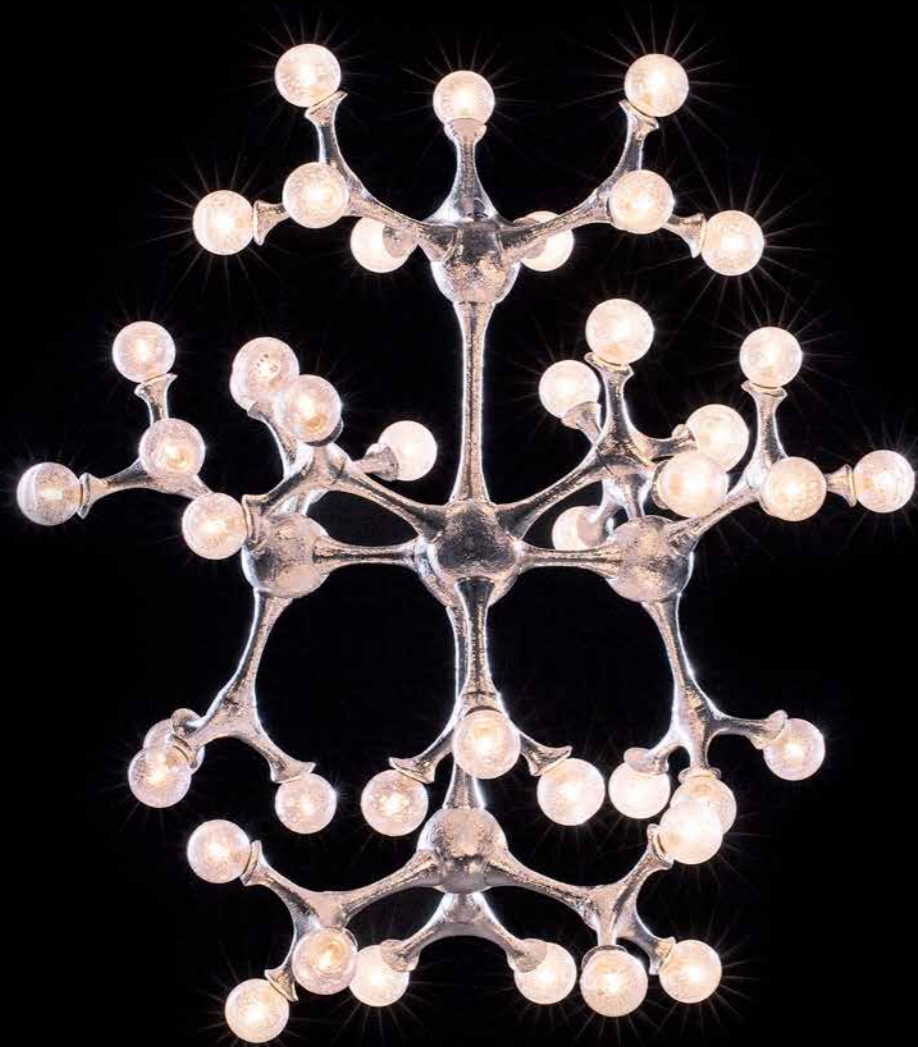

Itemnr: **PA 892**
Model: Organic Atomic hanging lamp
Sockets: 45x G4 LED
Finish: **-Dutch Silver**
 -Canadian Gold
Dimensions: L90xD80xH95cm

* Custom sizes on request. For images of the other finishes visit our website.

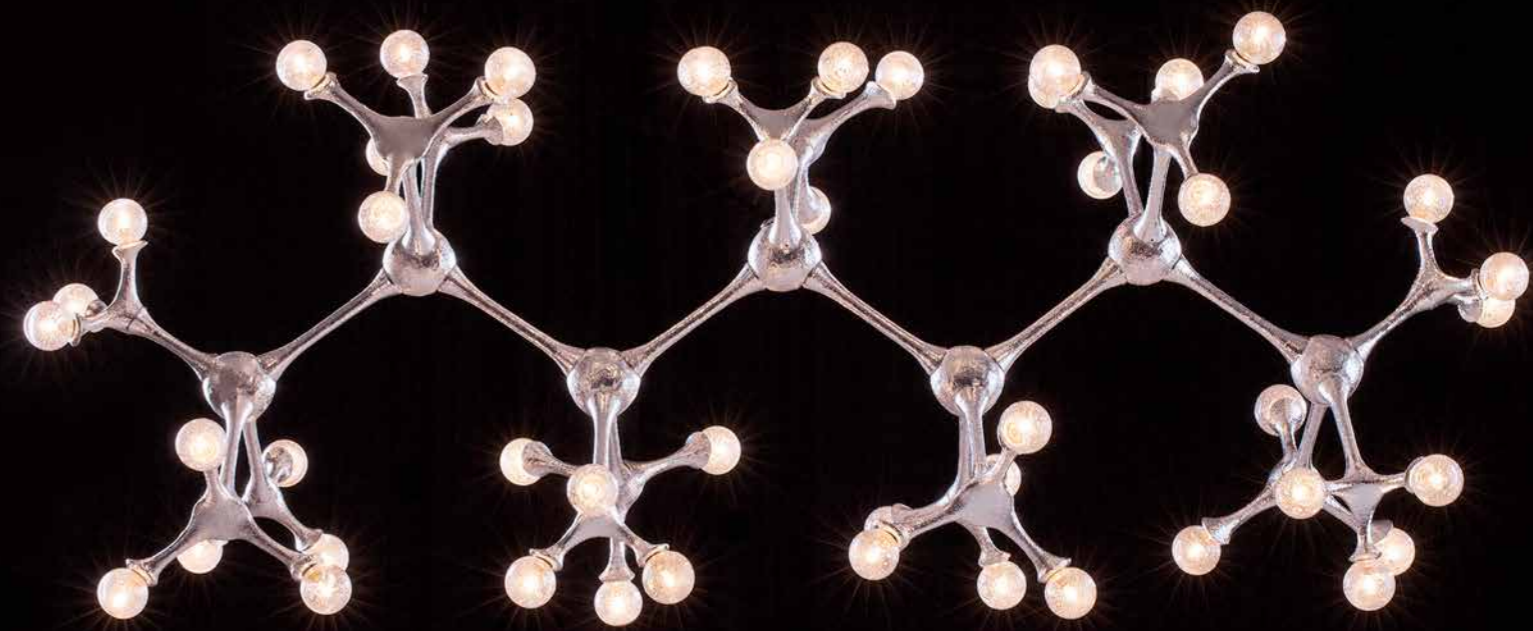

Itemnr: **PA 891**
Model: Organic Atomic hanging lamp XL
Sockets: 48x G4 LED
Finish: **-Dutch Silver**
 -Canadian Gold
Dimensions: L185xD70xH75cm

* Custom sizes on request. For images of the other finishes visit our website.



Itemnr: **PA 894**
Model: Organic Atomic hanging lamp round XL
Sockets: 75x G4 LED
Finish: **-Oxid silver**
-Oxid green
-Other finishes on request
Dimensions: Ø120cm / Ø 80cm

* Custom sizes on request. For images of the other finishes visit our website.



Itemnr: **PA 897**
Model: Organic Atomic table lamp
Sockets: 21x G4 LED
Finish: **-Oxid silver**
-Oxid green
-Other finishes on request
Dimensions: 65xH65cm

* Custom sizes on request. For images of the other finishes visit our website.



Itemnr: **PA 893**
Model: Organic Atomic wall sconce
Sockets: 9x G4 LED
Finish: **-Dutch Silver**
 -Canadian Gold
Dimensions: L50xD40xH55cm

* Custom sizes on request. For images of the other finishes visit our website.





MELTING FLOWERS

Flowers bring happiness, lightness and positive feelings. Inspired by his own garden, Pieter Adam began to mould these breath-taking products of nature in wax. With his designs, Pieter hopes to contribute to a joyful interior. For this, he most certainly succeeded with this Melting Flowers series existing of both hanging and wall lamps.

A flower is both beautiful on its own as well as bound together. This also accounts for the series of wall lights. One piece on itself is very decorative but filling a wall these objects are irresistible as well. All pieces are made by hand in brass and subsequently provided with a gold, rose gold or real silver layer.

The series of hanging lamps is very eye catching and perfectly suitable for a sophisticated setting. The flowers, in all their diversity, give these hanging lamps their appealing and lively appearance. The light is scattered in a unique and beautiful way, contributed by the thickness and silver spots of the glass bulbs. For these beautifully blown glasses, Pieter went to Italy where quality is still being made as he so much appreciates.

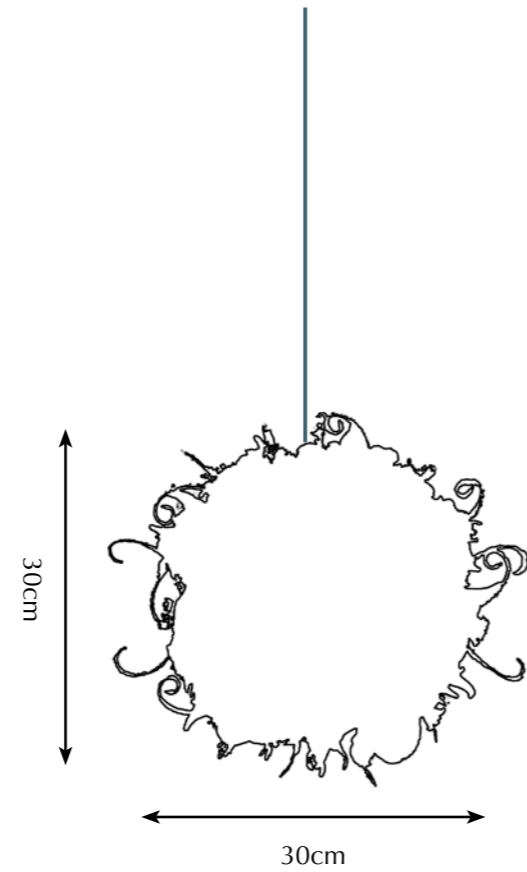

Itemnr: **PA 880**
Model: Melting Flowers hanging lamp small
Material: Casted Brass
Sockets: 12x G4 Halogen max. 5 Watt
Finishes: **-Gold base with silver flowers**
-Black base with gold flowers
-Gold/copper leaf and RAL colours for the base on request

* For images of the other finishes visit our website.

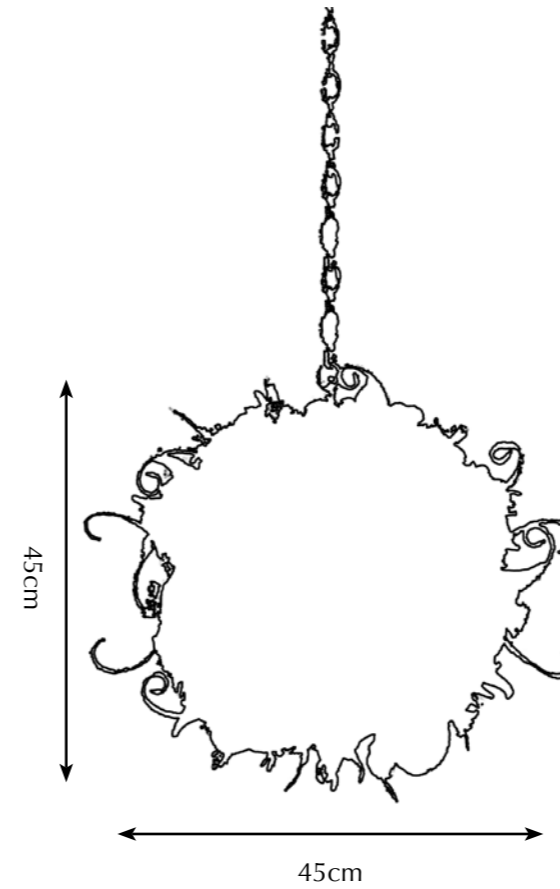

Itemnr: **PA 881**
Model: Melting Flowers hanging lamp medium
Material: Casted Brass
Sockets: 18x G4 Halogen max. 5 Watt
Finishes: **-Gold base with silver flowers**
-Black base with gold flowers
-Gold/copper leaf and RAL colours for the base on request

* For images of the other finishes visit our website.



STEP OUT OF THE SHADOW
BY PIETER ADAM

THE ONLY ENEMY OF ART IS TASTE

THOMAS HOVING

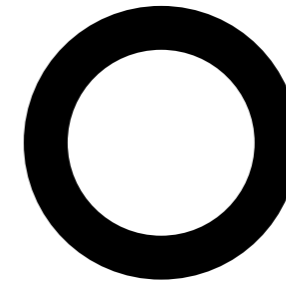

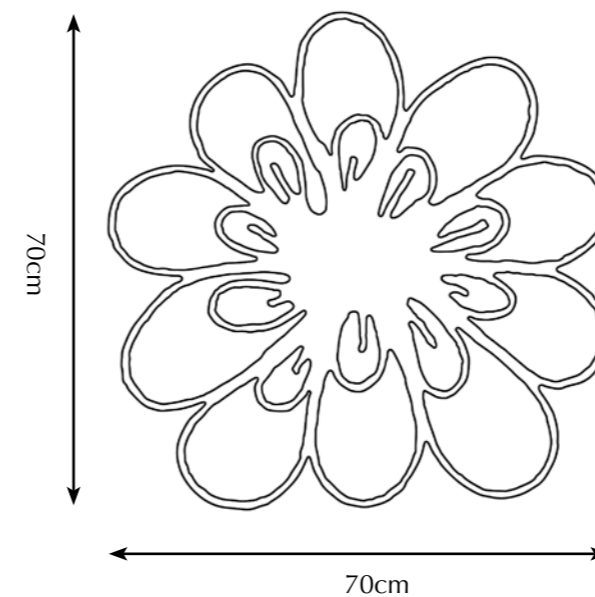
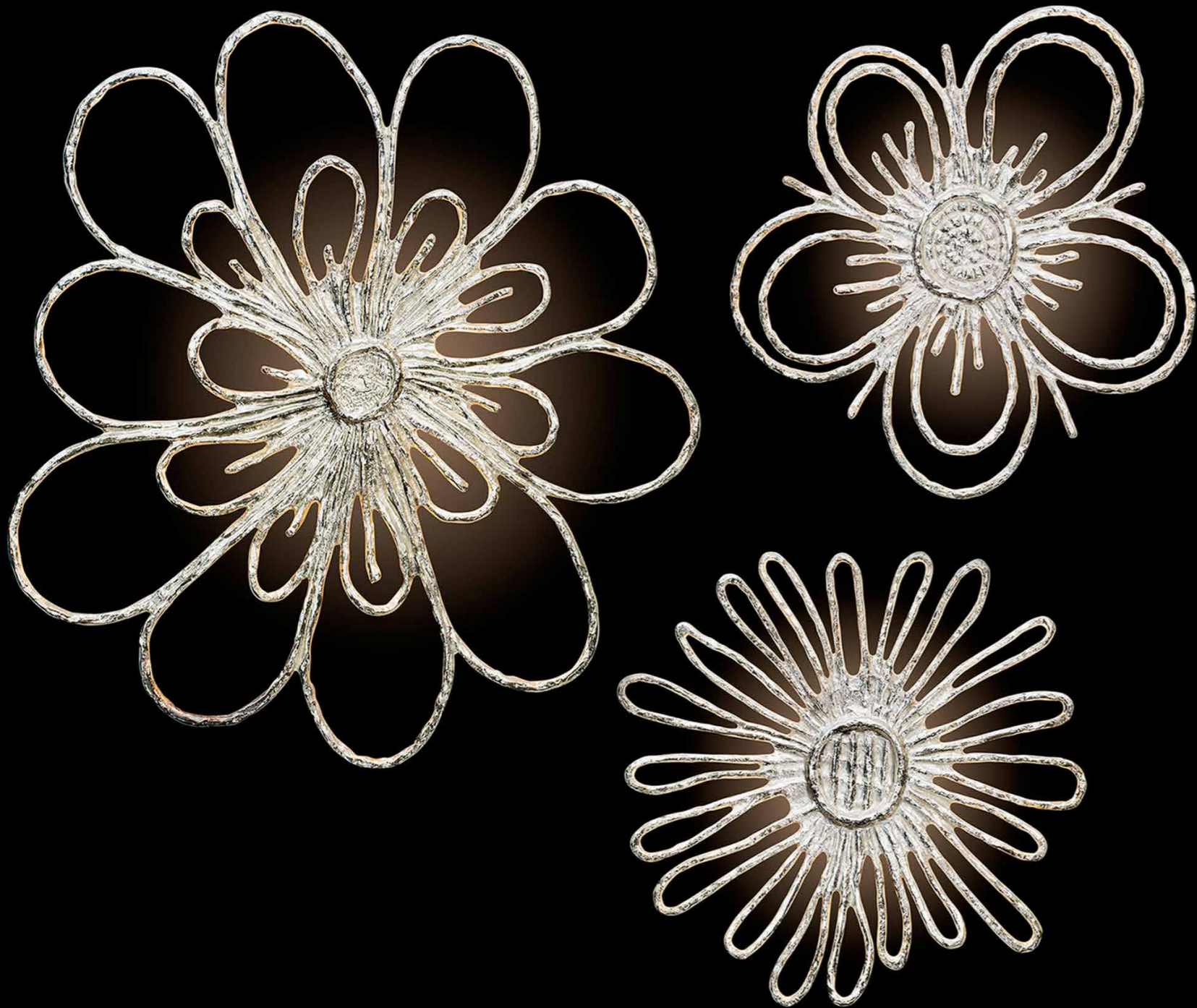

Itemnr: **PA 885**
Model: Melting Flowers wall lamp Dahlia
Material: Casted Brass
Sockets: 6x G4 Halogen max. 10 Watt
Finishes: -Dutch Silver
 -Canadian Gold
 -Rose Gold

* For images of the other finishes visit our website.

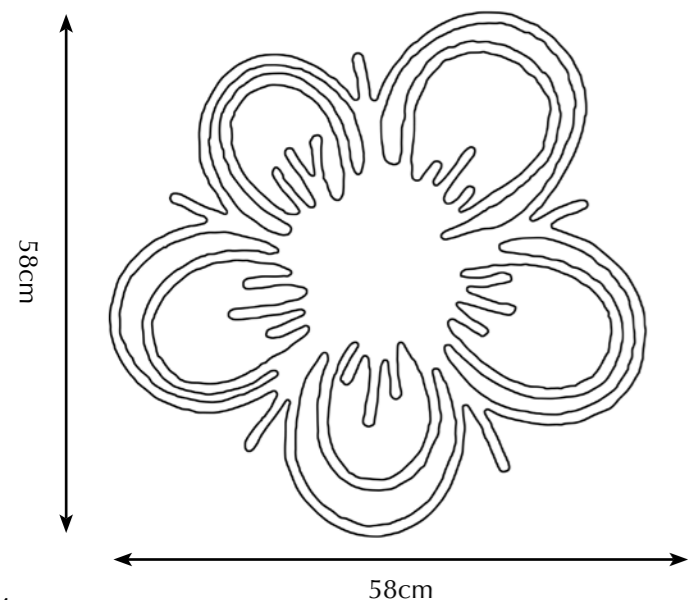

Itemnr: **PA 883**
 Model: Melting Flowers wall lamp Blossom
 Material: Casted Brass
 Sockets: 6x G4 Halogen max. 10 Watt
 Finishes: **-Dutch Silver**
 -Canadian Gold
 -Rose Gold

* For images of the other finishes visit our website.

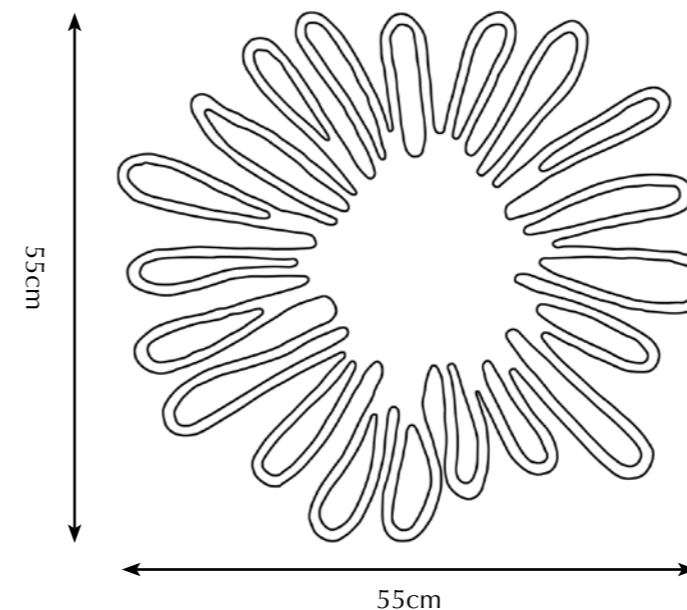

Itemnr: **PA 884**
 Model: Melting Flowers wall lamp Daisy
 Material: Casted Brass
 Sockets: 6x G4 Halogen max. 10 Watt
 Finishes: **-Dutch Silver**
 -Canadian Gold
 -Rose Gold

* For images of the other finishes visit our website.



MYSTERIOUS BAMBOO

Nature can work in mysterious ways, with its grace and curiosity serving as a great source of inspiration. In various Asian cultures bamboo is regarded a symbol for uprightness and tenacity. The plant is often endowed with traits as integrity, elegance, and optimism. The new Mysterious Bamboo series represents Pieter Adam's own interpretation of this noble plant, enriching it with a playfulness, joy and light-heartedness. The integrity and elegance in the detailing shows a great admiration of nature. An excellent choice for anyone looking to implement a botanical, mystic touch to their interior, perfectly fitting the present zeitgeist.

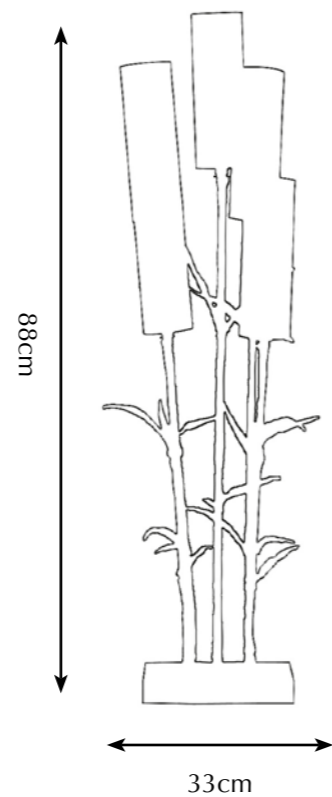

Itemnr: PA 901
Model: Mysterious Bamboo table lamp
Material: Casted brass
Shade: 1141 Honey Glow Silk
Sockets: 5x E14 max. 40Watt
Finish: **-Natural Brass**
-Dutch Silver

* For images of the other finishes visit our website.



Itemnr: PA 902
Model: Mysterious Bamboo floor lamp S
Material: Casted brass
Shade: P109 White Lacquer
Sockets: 3x E14 max. 40Watt
Finish: **-Natural Brass**
-Dutch Silver

* For images of the other finishes visit our website.



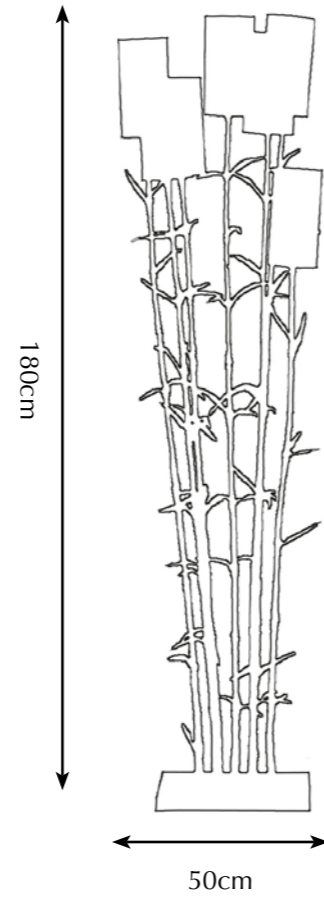

Itemnr: PA 903
Model: Mysterious Bamboo floor lamp L
Material: Casted brass
Shade: 5305 Pitch Black Silk
Sockets: 7x E14 max. 40Watt
Finish: **-Natural Brass**
-Dutch Silver

* For images of the other finishes visit our website.

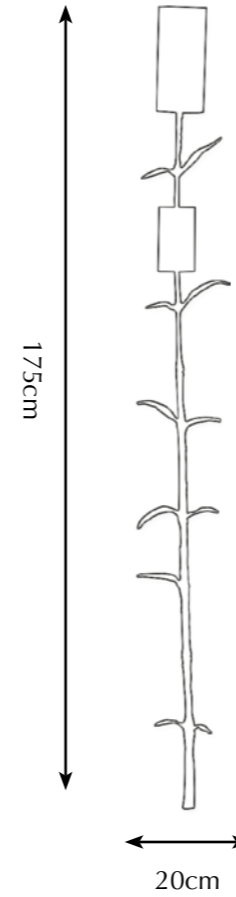

Itemnr: PA 904
Model: Mysterious Bamboo wall lamp
Material: Casted brass
Shade: 5305 Pitch Black Silk
Sockets: 1x E14 max. 40Watt
Finish: **-Natural Brass**
-Dutch Silver

* For images of the other finishes visit our website.





MELTING FEZ

With the Melting Fez series, Pieter Adam shows a new angle on combining varied authentic aesthetics. The sharp-edged curls, a Gothic decorative element, blend beautifully with the Moroccan feel of the lantern. The transparent, delicate fabric combined with the toughness and fickleness of the brass side lines, create a pleasant tension. The light sheltered in the stretched fabric adds a softness and warmth to the mystic sense this design exudes. Mysterious yet frivolous, this lush piece of characteristic lighting merges wonderfully in an ancient ambiance, complementing it with a contemporary twist.

This new series of lighting will soon be extended with wall lighting.

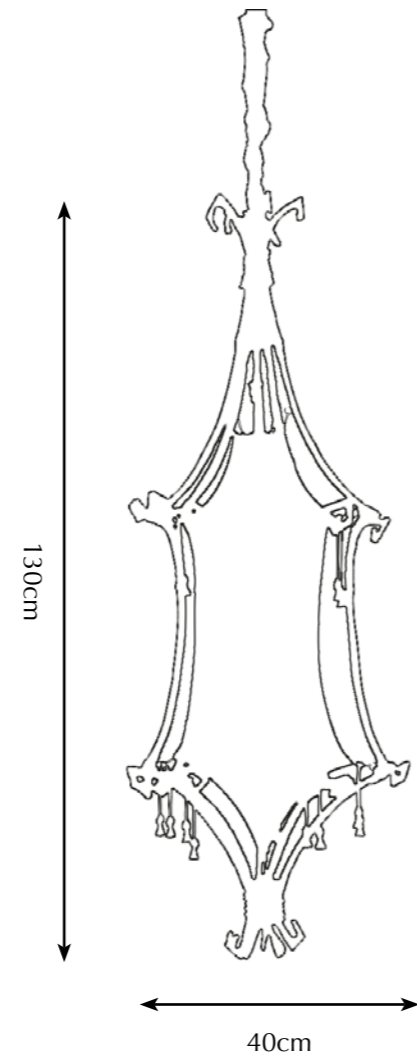

Itemnr: PA 501
Model: Melting Fez hanging lamp
Material: Casted brass
Sockets: 1x E27 max. 60Watt
Finish: -**Canadian Gold**
-Dark Bronze
-Dutch Silver

* Matching wall sconce coming soon.
For images of the other finishes visit our website.





MELTING FLORENCE

Melting Florence is Pieter Adam's first series of lighting that can be used both indoors as well as outdoors. The series consist of lanterns with a distinctive twist. The history of lanterns is long standing. Italian lanterns were Pieter's source of inspiration for designing his own version of this centuries-old form of light. As usual, he shows a completely own silhouette corresponding his language of form and shape. The distorted lines and the surprising organic shaping create a completely new interpretation of an ancient type of lighting.

Pieter Adam hopes you will enjoy these objects as much as he enjoyed making them. Fantasy does not know any boundaries.

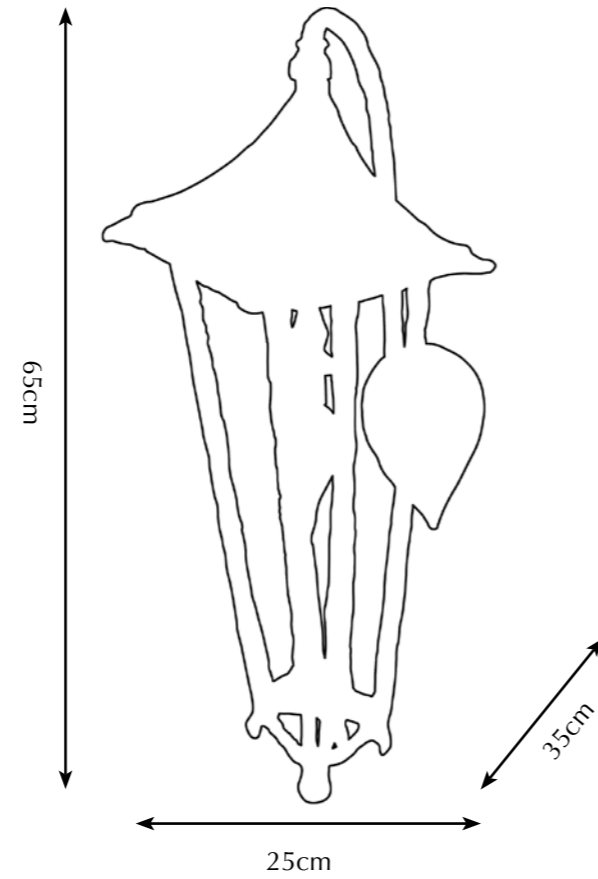

Itemnr: **PA 232 – PA 233**
Model: Melting Florence wall lantern medium
Material: Casted Brass
Sockets: G9 max. 25 Watt
Finishes: Dutch Silver

Also available in nickel finish, suitable for outdoor use.

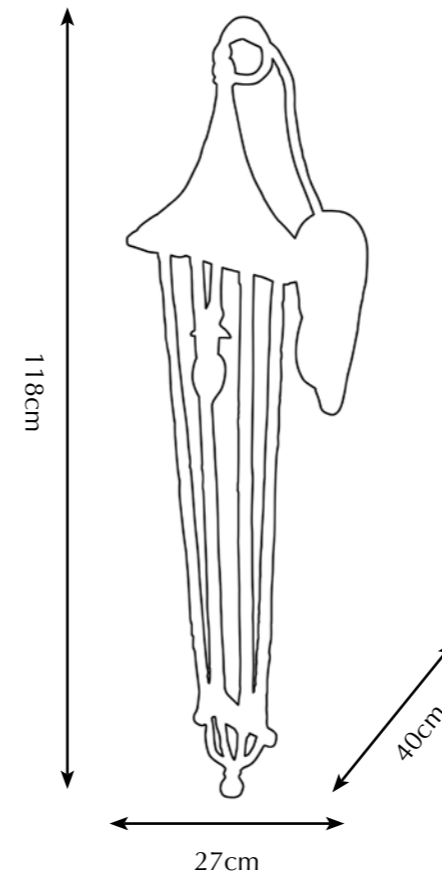

Itemnr: **PA 234 – PA 235**
Model: Melting Florence wall lantern large
Material: Casted Brass
Sockets: G9 max. 25 Watt
Finishes: Dutch Silver

Also available in nickel finish, suitable for outdoor use.



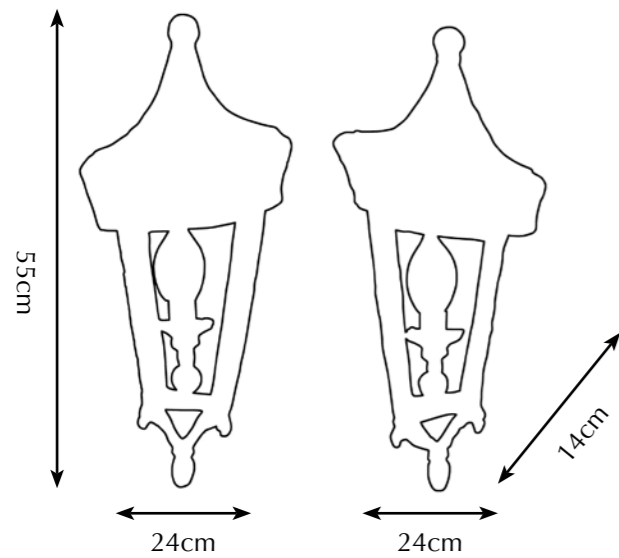

Itemnr: **PA 230 - PA 231**
Model: Melting Florence wall lantern small
Material: Casted Brass
Sockets: G9 max. 25 Watt
Finishes: Dutch Silver

* Also available in nickel finish suitable for outdoor use.

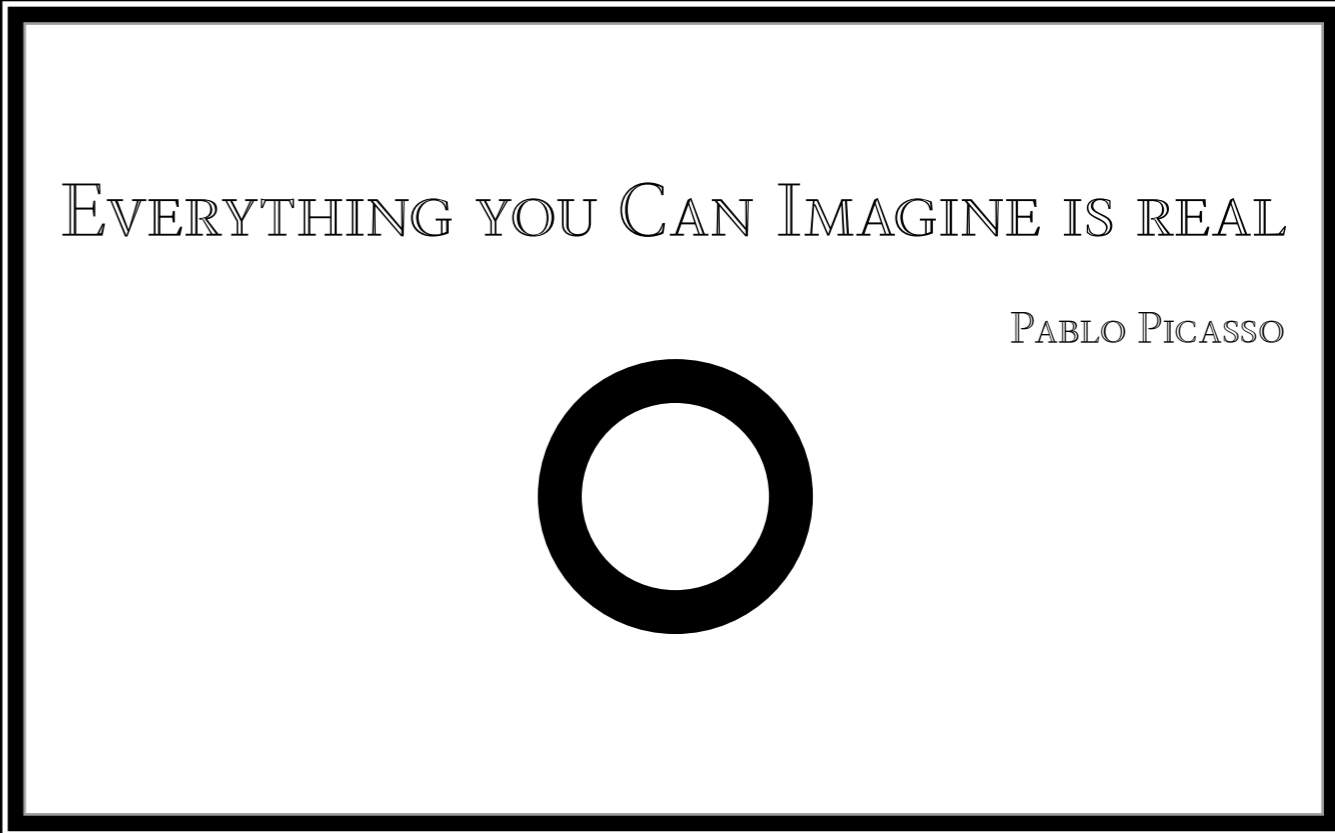



FRIDAY NIGHT AT THE BEACH

In his few spare moments, Pieter Adam finds the opportunity to do what he likes best: create objects fully corresponding with his idea of beautiful design. These dancing figures are remarkably lifelike and vividly shaped showing the designer's positive attitude and passion for the good and beautiful things in life. Casted in brass and finished in silver or gold, this sculpture truly shows Pieter Adam's great attention to detail and dedication to his craft. This is the first design within a series which will soon be expanded to include more sculptures.

Itemnr: **PA 601**
Material: Casted Brass
Dimensions: L75xD20xH45cm
Finishes: -Smoked Brass
-Dutch Silver
-Canadian Gold

* For images of the other finishes visit our website.



Mariëlle



Carola



Anne



Daniëlle

If you have any questions or requests, please do not hesitate to contact us.
We are always happy to assist!

For news (e.g. new collections, fairs/exhibitions etc.) visit our website or follow us on Facebook.



Distribution of Pieter Adam™ by:

Lumière

Lopikerweg oost 126

NL-3411 LZ LOPIKERKAPEL - The Netherlands

T +31 (0) 348 55 13 40 info@pieter-adam.com

F +31 (0) 348 55 30 04 www.pieter-adam.com

