

design

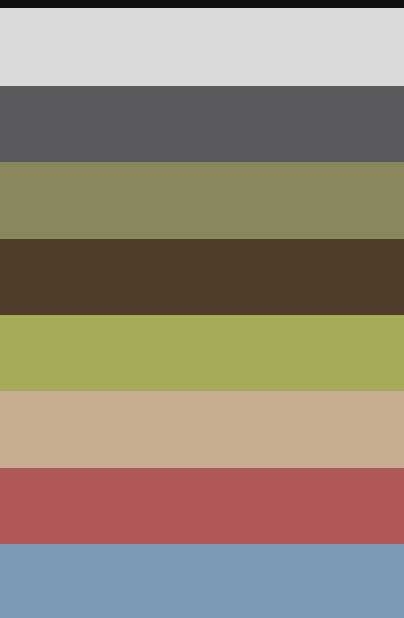

2015-2016

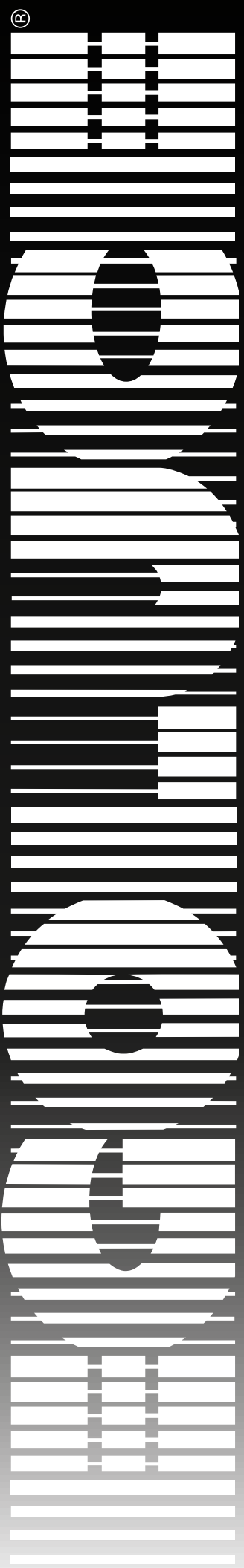

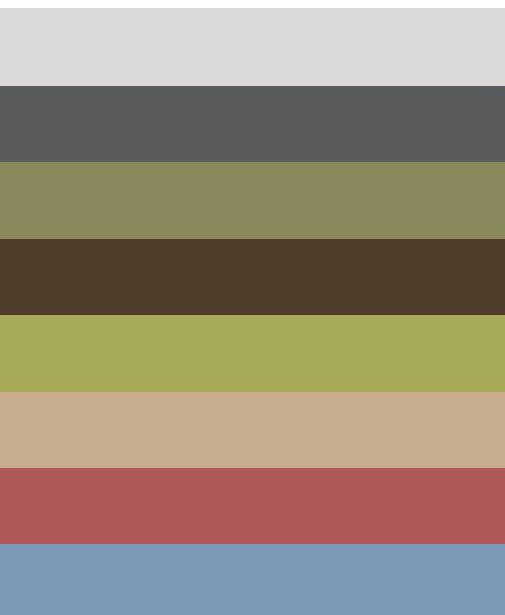

Novità - News	8
Sospensioni - Suspensions	50
Parete - Wall	144
Parete/soffitto - Wall/Ceiling	238
Soffitto - Ceiling	298
Terra - Floor	326
Tavolo - Table	346
Bagno - Bathroom	364



PIÙ DI 35 ANNI DI MADE IN ITALY

L'Italia è la culla della creatività. La tradizione artigianale e lo stile italiani sono conosciuti e ammirati in tutto il mondo, tanto che il marchio Made in Italy costituisce da sempre un valore aggiunto ambito e ricercato. Un prodotto italiano è immediatamente riconoscibile per la cura dei particolari e i valori estetici che esprime.

Nel solco di questa grande tradizione, dal 1978 EGOLUCE crea prodotti Made in Italy, collaborando con aziende e artigiani italiani per garantire ai propri clienti un prodotto dagli altissimi contenuti tecnologici e di design. La rigorosa selezione qualitativa dei componenti e dei materiali e la lavorazione guidata dai criteri della qualità totale ci consente di produrre e offrire alla clientela una vasta gamma di apparecchi per tutti i tipi di utilizzo. Prodotti dei quali siamo fieri e orgogliosi. **Prodotti Made in Italy.**

SVILUPPO SOSTENIBILE

Il tema del riscaldamento globale e dell'impellente necessità di ridurre i consumi e le emissioni di CO2 è ormai noto a tutti, ed ognuno di noi è tenuto a fare la propria parte, grande o piccola che sia.

EGOLUCE, sensibile al problema rivede la propria collezione e propone in questo catalogo numerosi prodotti con sorgenti a basso consumo, evidenziandoli all'attenzione del consumatore con il marchio ES (Energy Saving) aiutandolo così a compiere scelte consapevoli ed a contribuire all'impegno di tutti per garantire uno sviluppo sostenibile.



MORE THAN 35 YEARS OF MADE IN ITALY

Italy is the cradle of creativity. Its artisan tradition and style are known and admired throughout the world, so much so that the Made in Italy mark has always constituted sought-after added value. An Italian product can immediately be recognized for the attention to details and the aesthetic values it expresses.

In the wake of this great tradition, since 1978 EGOLUCE has been creating Made in Italy products, mostly collaborating with Italian companies and craftsmen in order to offer its clients a high tech and design product. The rigorous selection of high-quality components and materials and the processing guided by criteria such as total quality enable us to produce and offer clients a vast range of light fixtures for all types of use. Products of which we are very proud.

Products Made in Italy.

SUSTAINABLE DEVELOPMENT

Global warming and the urgent need to drastically cut energy consumption and CO2 emission are now worldwide recognized problems. In this new era of awareness everyone has a role to play, no matter how small or big.

EGOLUCE is an environmentally conscious company and has revised his collection proposing in this catalogue a wide range of low consumption products which are highlighted by the mark ES (ENERGY SAVING). This is a way to help consumers to make ecofriendly choices contributing in this way to sustainability.

Layout



Disegno tecnico
Technical drawing

Dati tecnici
Technical Data

Codice prodotto Product code	1519	7,7 kg
	53W E27 ECO	
	16W E27 Fluo EL	
	10W E27 Led (cod. 0105)	
	F	
Finiture Finishes	.00	

EGOLUCE
TODAY

il 2015 è stato proclamato dall'UNESCO l'anno internazionale della luce e delle tecnologie basate sulla luce. Il mondo dell'illuminazione vive quest'anno particolare in un contesto tecnologico in rapida evoluzione che crea straordinarie opportunità d'innovazione.

Anche per EGOLUCE questo è un anno ricco di novità che coinvolgono ed aggiornano sia la collezione design che quella decorativa. Il catalogo si arricchisce di apparecchi dal design innovativo in grado di appagare sia per l'estetica accattivante che per le caratteristiche tecnico/funzionali.

Nel contempo numerosi altri prodotti sono stati modificati o riprogettati per adattarli alle nuove tecnologie recentemente sperimentate nella collezione tecnica.

Il layout del catalogo, totalmente rinnovato, è pensato per facilitarne la consultazione.

Nelle pagine iniziali presenta un'ampia anteprima delle novità che rientrano poi nei capitoli successivi, con tutti gli altri prodotti, secondo una divisione tipologica.

2015 was proclaimed by UNESCO as International Year of light and light-based technologies .

The lighting industry lives this particular year with a technological background in rapid evolution which creates great opportunities for innovation .

Also for EGOLUCE this is a year full of news with an upgrade of both the design and the decorative collection. The catalog is enriched with innovative design products attractive for their look and at the same time for their technical / functional features .

At the same time a number of other fixtures have been modified or redesigned to suit the new technologies recently adopted and tested in the technical collection.

The totally renovated layout of the catalogue is designed for easy reference.

The opening pages are dedicated to a large preview of the new products that are repeated later, with all others, in each section organized by type.

EGOLUCE
CUSTOM
MADE

EGOLUCE per le tue soluzioni 'su misura'.

Ci piace pensare di poter essere per voi non "un fornitore qualunque", ma un partner a cui rivolgersi nel momento in cui sorge la necessità di una realizzazione particolare. Uno dei punti di forza del produrre ancor oggi in Italia è quello di poter rispondere in tempi brevi alle vostre richieste speciali siano esse relative a misure, colori, tonalità di luce o caratteristiche tecniche come dimmerabilità o luce d'emergenza.

EGOLUCE for your 'tailored' solutions

We like to think we can be for you not only "one supplier as any other", but a partner to turn to when the need arises for a customization. One of the advantages of producing still today in Italy is to be able to respond quickly to your special requests. No matter whether they are related to sizes, colors, light colors or technical features such as dimming or emergency lighting.

Novità - News



Alealed p 28



Ci p 24



Lancia p 32



Mats p 20



Megavide p 10



Pupilla p 36



Rail p 44



Roc p 40



Spirits p 16

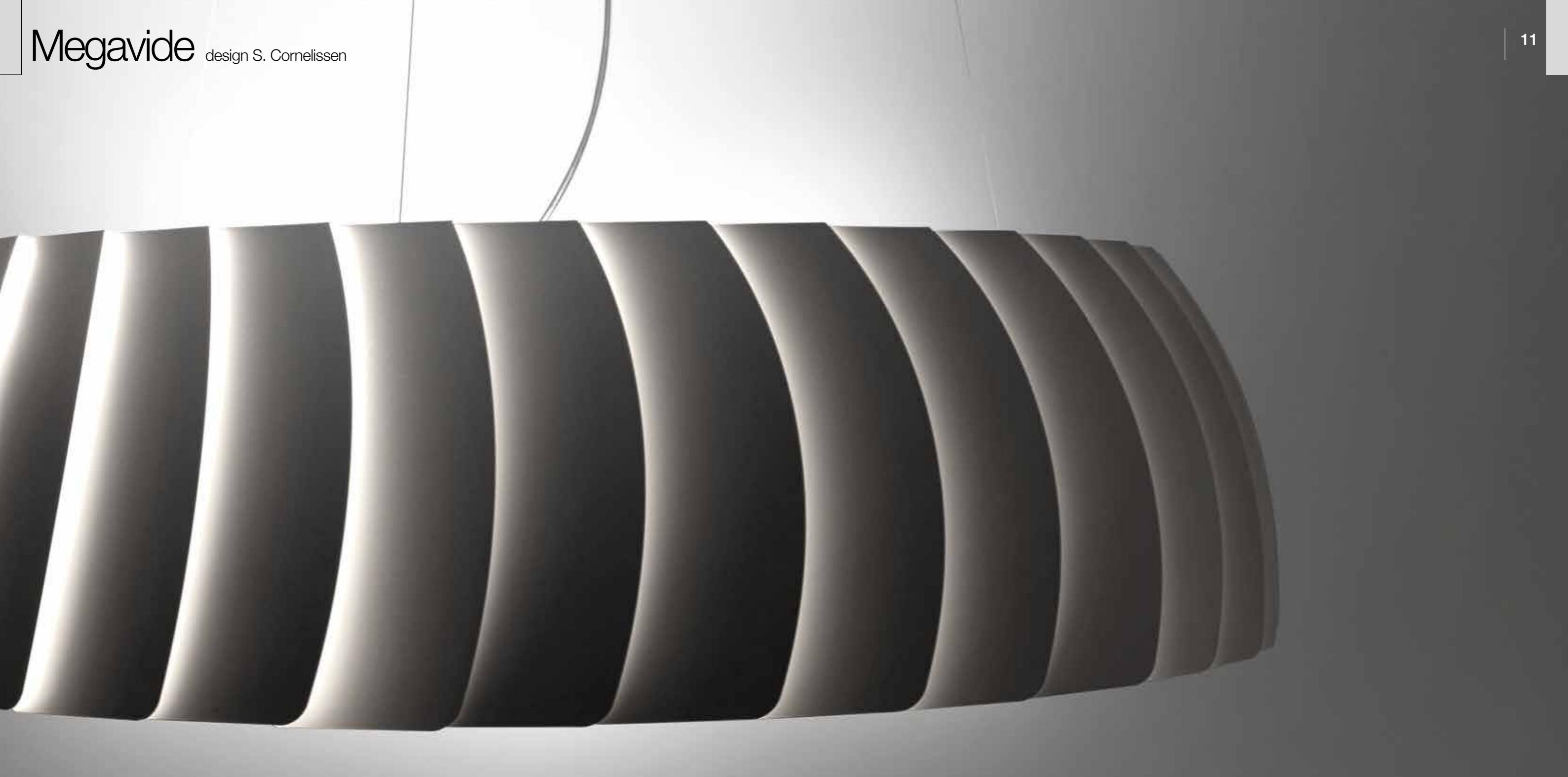

Lampade a sospensione o soffitto di grandi dimensioni dotate di sorgente LED. Struttura ed elementi modulari del diffusore sono realizzati in alluminio verniciato. Le versioni a soffitto sono dotate di un disco bianco riverniciabile per nascondere l'alimentatore e simulare l'effetto di un apparecchio a scomparsa. Alimentatore incluso.

Large Suspensions or ceiling lamps fitted with LED light engine. Structure and modular elements of the shade realized in painted aluminum. Ceiling version includes a white re-paintable panel to hide converter and simulate the effect of a recessed fixture. Converter on board.

Suspensions ou lampes à plafond de grandes dimensions équipés avec des sources LED. Structure et éléments modulaires du diffuseur réalisés en aluminium verni. Les versions à plafond incluent un panneau blanc qui peut être peint pour cacher le convertisseur et simuler l'effet d'un luminaire encastré. Convertisseur inclus.

Großformatige Pendel- oder Deckenleuchten mit LED Technik. Struktur und modulare Elemente des Schirms aus lackiertem Aluminium. Die Deckenleuchten werden mit einem weißen, lackierbaren Paneel zur Abdeckung des Konverters geliefert (gleicher Effekt wie bei Einbau). Inklusive Konverter.

Lámparas colgantes o de techo de grande diámetro equipadas con fuente de luz LED. Estructura y elementos modulares de la sombra realizados en aluminio pintado. Versión de techo incluye un panel blanco repintable para ocultar el convertidor y simular el efecto de un aparato empotrado. Convertidor incluido.

Большой подвесной или потолочный светильник на светодиодах. Структура и детали из окрашенного алюминия. Потолочные модели с окрашиваемой панелью, за которой прячется конвертер. Конвертер включен.

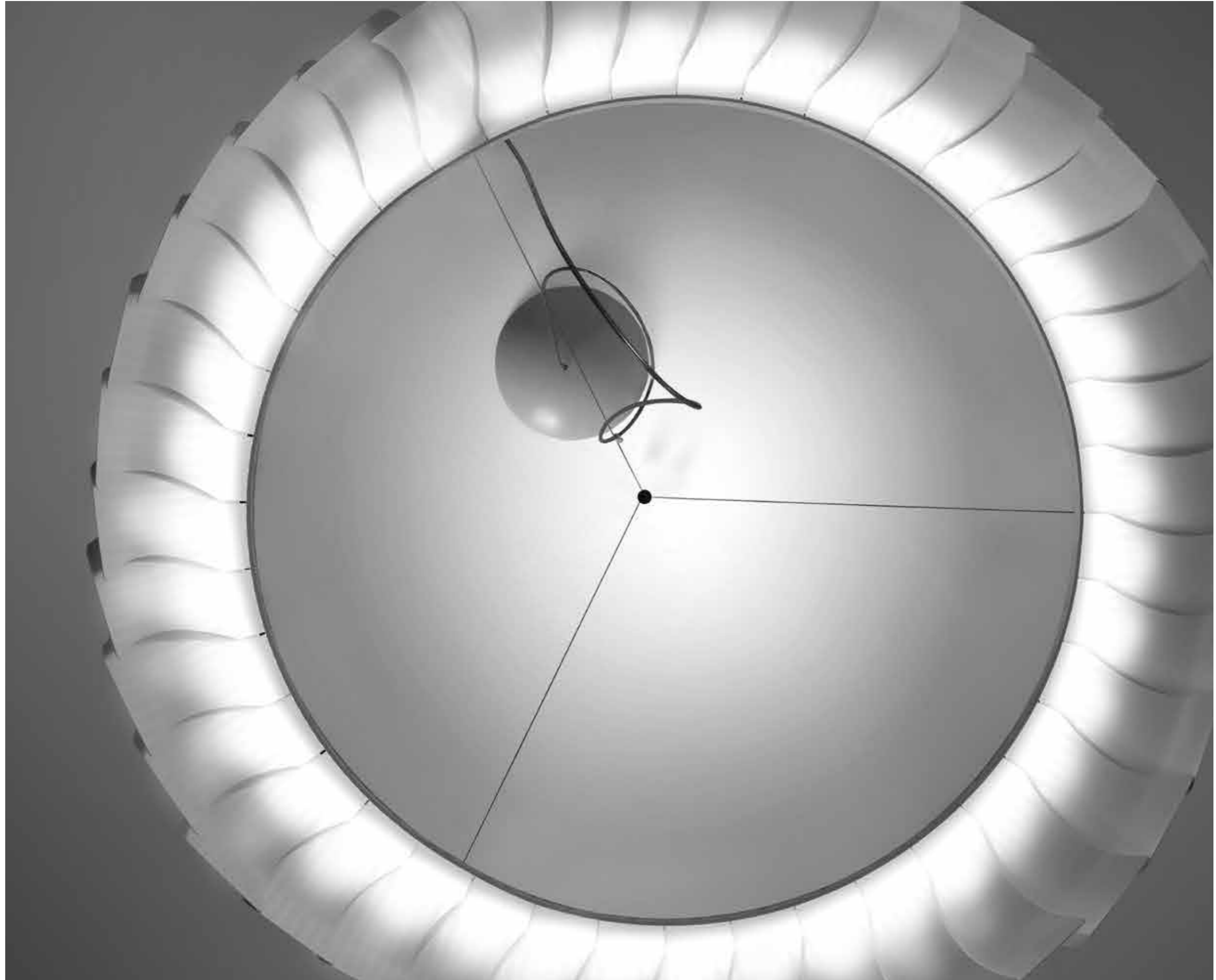
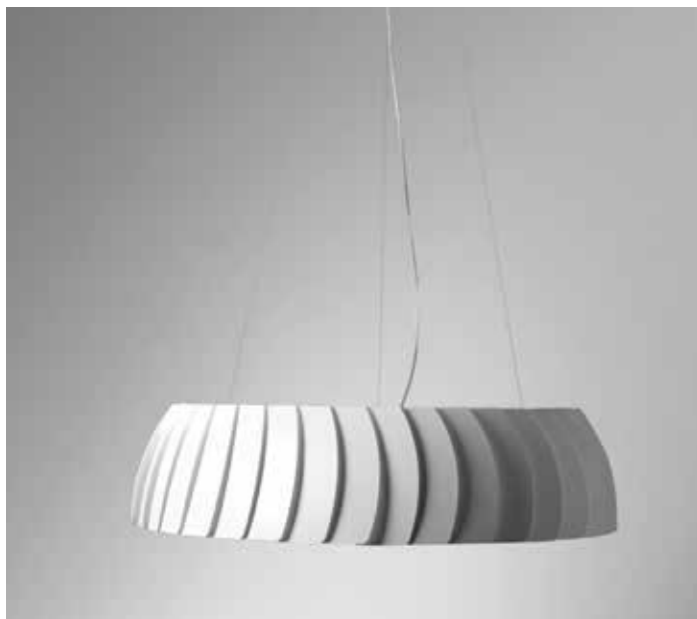





Lampade a sospensione realizzate in alluminio. Un design innovativo che, rivisitando forme classiche, inventa per esse nuove funzioni ed effetti.

L'insolito posizionamento delle sorgenti LED nella parte bassa dell'apparecchio crea riflessi e proiezioni di luce inattese. Disponibile nelle finiture: Bianco, Nero/foglia oro.

Rosoni o piastre con alimentatore incluso da ordinare separatamente.

Pendant lamps made of aluminium. An innovative design that revisits classic shapes inventing for them new functions and effects. The unusual positioning of the LED sources in the lower part of the unit creates unexpected light reflections and projections. Available in white or black/gold leaf.

Canopy or fixing plates including converter are sold separately.

Suspension en aluminium. Un design innovant qui, revisitant des formes classiques, invente de nouvelles fonctions et effets. Le positionnement inhabituelle des sources LED dans la partie inférieure de l'appareil crée des réflexions et des projections de lumière inattendus. Disponible en blanc ou noir/feuille d'or.

Rosace ou plaque de fixation avec convertisseur inclus à commander séparément.

Pendelleuchte aus Metall. Ein innovatives Design, das klassische Linien aufgreift und sie mit neuen Funktionen und Effekten verbindet. Die außergewöhnliche Positionierung der LEDs im unteren Teil des schafft unerwartete Lichtreflexionen und Projektionen. Erhältlich in weiß oder schwarz/Blattgold. Baldachin oder montageplatte inklusive Konverter separat bestellen.

Colgante de metal. Un diseño innovador que revisita formas clásicas inventando por esas nuevas funciones y efectos. El posicionamiento inusual de las fuentes de luz LED en la parte baja de la unidad crea reflejos de luz y proyecciones inesperadas. Disponible en acabado blanco o negro/hoja de oro. Baldaquin o placas de anclaje con convertidor incluido a pedir por separado.

Серия подвесных светильников из металла. Инновационный дизайн придает классическим формам новые функции и эффекты. Необычное расположение светодиодов в нижней части светильника создает неожиданные отражения и проекции света. Цвета: белый или черный/золотой лист. Конвертер включен.



Sistema di apparecchi da parete realizzati con sorgenti COB LED.
Corpo in metallo verniciato, disponibile in due dimensioni, finiture: bianco, nero e sabbia. Include accessorio per cablaggio passante che permette di collegare più apparecchi ad un unico punto d'alimentazione. Alimentatore integrato.

System of wall lamps fitted with COB LED light engine.
Painted metal body available in two dimensions, finishes: white, black and sand. A wiring accessory allowing to connect more units to a single cable outlet is included. Converter on board.

Système d'appliques équipées avec technologie COB LED.
Corps en métal verni disponible en deux dimensions, finitions: blanc, noir et sable. Un accessoire de câblage inclus permet de connecter plusieurs unités à un seul point d'alimentation. Convertisseur intégré.

Wandleuchten-System mit COB LED-Modulen. Körper aus lackiertem Metall, erhältlich in zwei Größen. Ausführungen: weiß, schwarz und sand. Zubehör zur Durchgangsverdrahtung mehrerer Elemente inbegriffen. Integrierter Konverter.

Sistema de lámparas de pared equipados con fuente de luz COB LED.
Cuerpo de metal pintado disponible en dos tamaños, acabados: blanco, negro y arenoso. Está incluido un accesorio que permite conectar mas unidades a un solo punto de alimentación. Convertidor integrado.

Система настенных светильников со светодиодами на плате. Металлический корпус есть в 2 размерах и цветах: белый, черный песчаный. Аксессуар, позволяющий подключить несколько приборов к одному силовому кабелю. Конвертер включен.



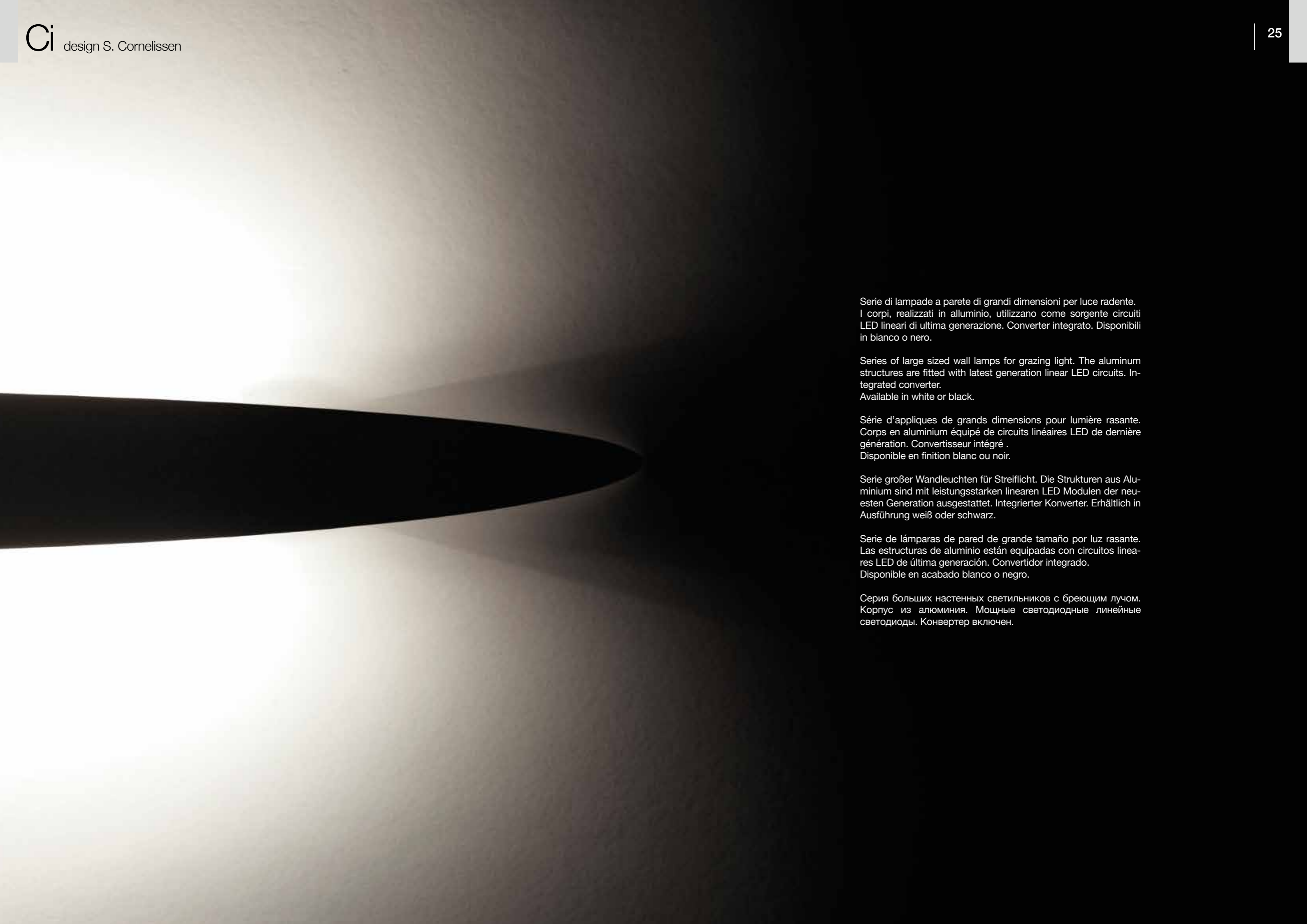

Serie di lampade a parete di grandi dimensioni per luce radente. I corpi, realizzati in alluminio, utilizzano come sorgente circuiti LED lineari di ultima generazione. Converter integrato. Disponibili in bianco o nero.

Series of large sized wall lamps for grazing light. The aluminum structures are fitted with latest generation linear LED circuits. Integrated converter. Available in white or black.

Série d'appliques de grands dimensions pour lumière rasante. Corps en aluminium équipé de circuits linéaires LED de dernière génération. Convertisseur intégré. Disponible en finition blanc ou noir.

Serie großer Wandleuchten für Streiflicht. Die Strukturen aus Aluminium sind mit leistungsstarken linearen LED Modulen der neuesten Generation ausgestattet. Integrierter Konverter. Erhältlich in Ausführung weiß oder schwarz.

Serie de lámparas de pared de grande tamaño por luz rasante. Las estructuras de aluminio están equipadas con circuitos lineares LED de última generación. Convertidor integrado. Disponible en acabado blanco o negro.

Серия больших настенных светильников с бреющим лучом. Корпус из алюминия. Мощные светодиодные линейные светодиоды. Конвертер включен.



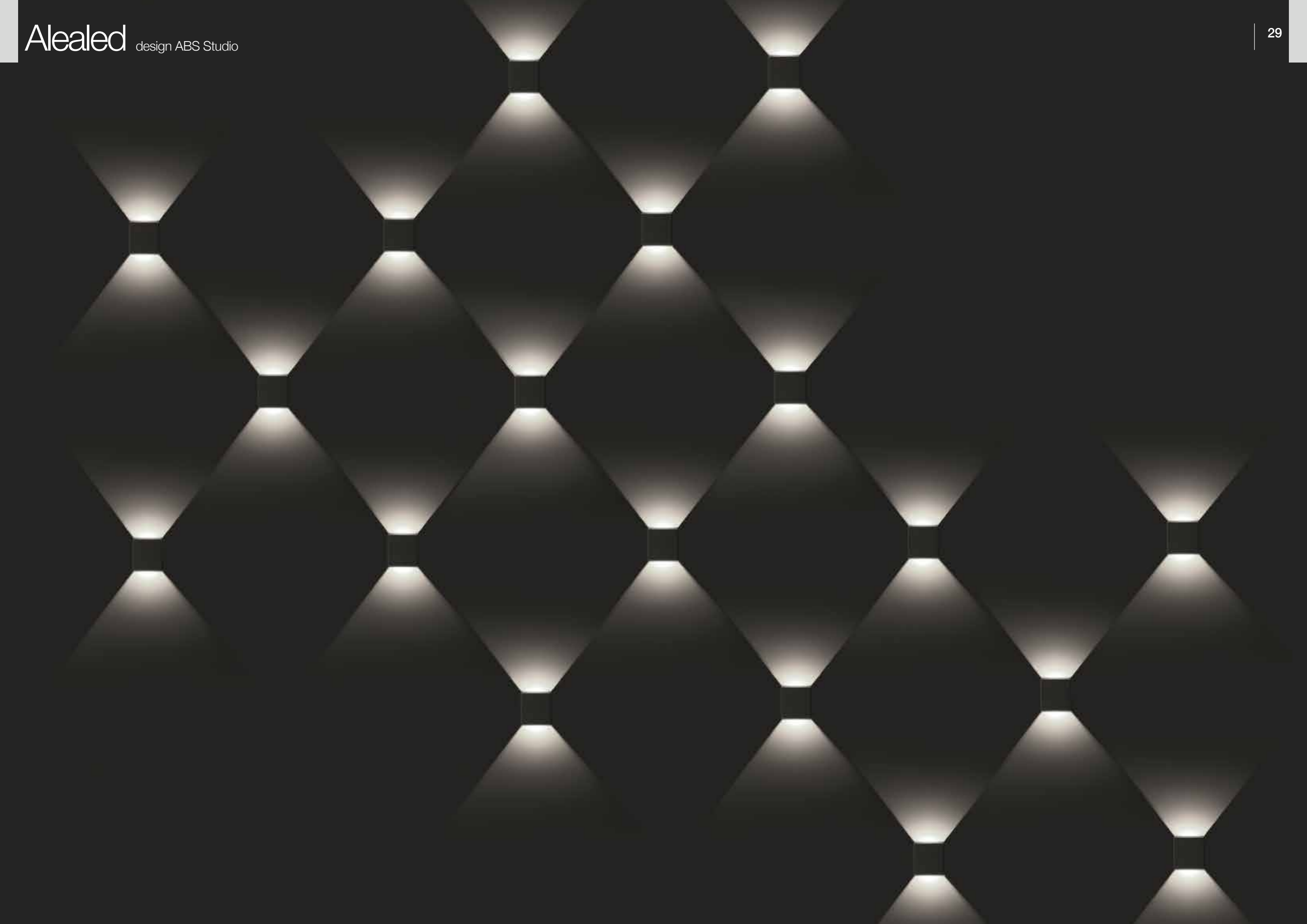



Lampada da parete in alluminio verniciato con sorgente COB LED ed alimentatore integrato. Disponibile nelle finiture: bianco, cromo, sabbia, nero/oro e bianco/fucsia.

Wall lamp in painted aluminum fitted with COB LED light engine and converter on board. Available in following finishes: white, chromed, sand, black/gold and white/fuchsia.

Applique en aluminium verni avec source de lumière COB LED et alimentation intégrée. Disponible dans les finitions: blanc, Chromé, sable noir/or et blanc/fuchsia.

Wandleuchte aus lackiertem Aluminium mit COB LED-Modul. Integrierter Konverter. Erhältlich in folgenden Ausführungen: Weiß, Verchromed, Sand schwarz/Gold und weiß/fuchsia.

Lámpara de pared en aluminio pintado equipado con fuente de luz COB LED y convertidor integrado. Disponible en los siguientes acabados: blanco, cromado, arena, negro/oro y blanco/fucsia.

Настенный светильник из окрашенного алюминия. Светодиод на плате. С конвертером. Отделки: белая, хром, песочная, черная/золотая и белая/фуксия.





Serie di lampade orientabili da parete, sospensione o terra.

I circuiti lineari LED con CRI 90, garantiscono una resa cromatica ottimale per l'illuminazione di quadri. Struttura in alluminio verniciato bianco, diffusore in metacrilato satinato.

La versione da terra prevede anche un utilizzo a parete grazie all'apposito attacco incluso.

Le versioni a sospensione sono realizzabili, a richiesta, in misure speciali modulari.

Series of adjustable wall-lamps, suspensions or standing.

Fitted with linear LED circuits granting CRI 90 in order to achieve optimal color rendering for pictures lighting. Structure in white painted aluminum and satin methacrylate diffuser.

The floor version includes an additional bracket that allows wall installation.

Suspended versions are available, upon request, in modular special lengths.

Série de lampes réglables applique, suspension ou lampadaire. Équipé avec circuits linéaires LED délivrant un CRI 90 pour garantir une rendue couleurs optimale dans l'éclairage de tableau. Structure en aluminium laqué blanc et diffuseur en méthacrylate satiné. La version lampadaire est doué d'une patère supplémentaire qui permet l'installation murale. Les versions suspension sont disponibles, sur requête, dans des longueurs modulaires spéciaux.

Serie von ausrichtbarer Wand-, Pendel- und Stehleuchten.

Ausgestattet mit LED-Modulen CRI >90, um die optimale Farbwiedergabe bei der Beleuchtung von Bildern zu erzielen. Struktur aus weiß lackiertem Aluminium und Diffusor aus satinierem Acrylglas.

Die Stehleuchte bietet eine zusätzliche Halterung für eine etwaige Wandbefestigung.

Pendelversionen sind, auf Anfrage, auch in modularen Sonderlängen lieferbar.

Serie de lámparas ajustables de pared, colgantes y de pie.

Equipados con circuitos lineares LED con CRI 90 para alcanzar un índice de reproducción cromática óptimo para la iluminación de cuadros. Estructura de aluminio pintado blanco y difusor de metacrilato satinado.

La versión de pie incluye un soporte adicional que permite la instalación a pared.

Las versiones suspendidas están disponibles, previa solicitud, en medidas modulares especiales.

Серия настенных, подвесных или напольных поворотных светильников. Линейные светодиодные модули гарантируют индекс цветопередачи CRI>90, идеальны для подсветки картин. Корпус из окрашенного алюминия, диффузор матовый метакрилат. Торшер снабжен кронштейном, позволяющим крепить также к стене. Подвесные варианты могут быть исполнены по запросу в других размерах.



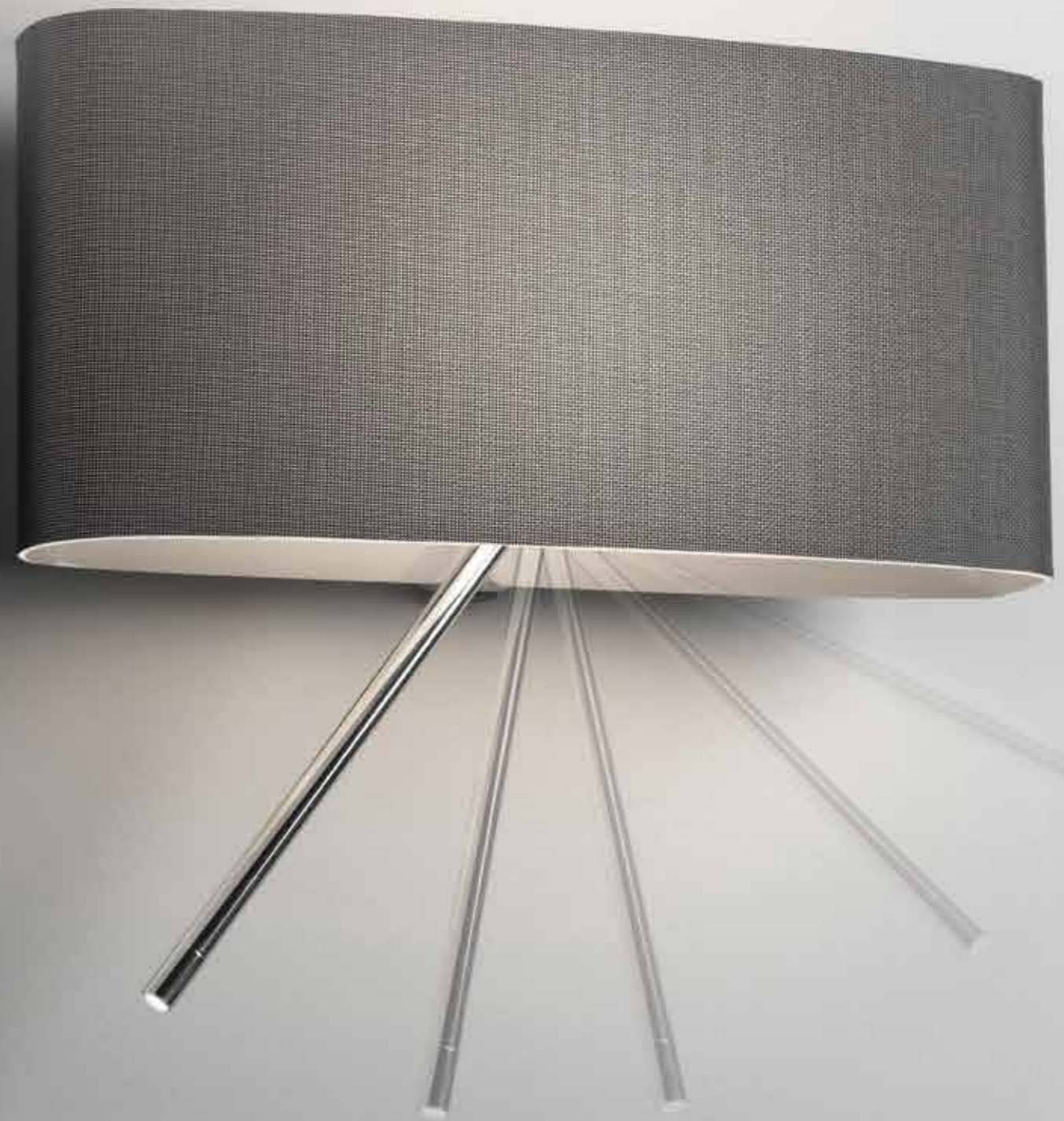

Lampada da parete con o senza luce orientabile da lettura integrata. Diffusore in metacrilato opalino rivestito in tessuto tecnico ignifugo nero o grigio perla. La luce diffusa viene fornita da una piastra LED a tensione di rete 220/240V, mentre per la luce da lettura viene utilizzando un power LED con alimentatore a bordo.

Wall lamps with or without integrated adjustable reading light. Opal methacrylate diffuser coated with composite fabric fireproof black or pearl grey. Ambiance lighting is granted by a LED plate for main supply 220-240V, whereas personal reading light is supplied by a power LED with converter on board.

Applique avec ou sans lampe de lecture orientable intégrée. Diffuseur en méthacrylate opalin couvert en tissu composite ignifuge noir ou gris perl.

La lumière diffusée est fournie par une plaque LED à tension du réseau 220 / 240V; pour la lumière de lecture on utilise une LED de puissance avec convertisseur a bord.

Wandleuchte mit oder ohne integrierte ausrichtbare Leseleuchte. Diffusor aus opalisiertem Acrylglas, mit Kunstfasergewebe feuerfestem schwarz oder perlgrau beschichtet. Die Wandleuchte ist mit einem LED Modul für Netzspannung 220-240V ausgestattet, die Leselampe mit einem LED-Modul und integriertem Konverter.

Lámparas de pared con o sin luz de lectura ajustable integrada. Difusor de metacrilato opalino recubierto con tejido compuesto ignifugo negro o gris perla. Por la iluminación ambiente se utiliza placa de LED para tensión de red 220-240V mientras la luz de lectura es suministrada por un LED de potencia con convertidor integrado.

Бра со встроенной лампой для чтения или без нее. Диффузор из матового метакрилата, покрытого композитной Серой или черной тканью. Светодиодная плата, подключенная в сеть 220в, дает рассеянный свет, а мощный диод с конвертером дает свет для чтения.





Lampada da esterno IP65 per installazione a soffitto/parete. Corpo in alluminio anodizzato e verniciato bianco, schermo in metacrilato opalino. Diffusore in vetro pressato lucidato. Modulo LED da 700Lm a tensione di rete 220/240V di ultima generazione.

Ceiling/wall lamp IP65 for outdoor use. Aluminum body is anodized and white painted, opal methacrylate screen. Polished pressed glass diffuser. The lamp is fitted with 700Lm latest generation LED plate for main supply 220-240V.

Plafonnier/applique IP65 pour usagen extérieur. Corps en aluminium anodisé et verni blanc et écran de méthacrylate opalin. Diffuseur en verre pressé poli. Module LED 700Lm LED à tension du réseau 220-240V de nouvelle génération.

Wand- und Deckenleuchte für Außenbereiche mit Schutzart IP65. Gehäuse aus eloxiertem und weiß lackiertem Aluminium, Schirm aus opalisiertem Acrylglas. Diffusor aus Pressglas poliert. Die Leuchte ist ausgestattet mit einem 700lm LED-Modul neuester Generation für Netzspannung 220-240V.

Lámpara de techo/pared IP65 para exteriores. Cuerpo de aluminio anodizado y pintado blanco. Pantalla de metacrilato opalino y difusor de cristal prensado pulido. La lámpara está equipada con modulo LED 700Lm de última generación para tensión de red 220-240V.

Потолочный/настенный светильник для наружного использования IP65. Анодированный алюминий, окрашен в белый цвет. Рассеиватель из матового метакрилата. Диффузор из сверхяркого прессованного стекла. Светодиод на плате последнего поколения 700мА для подключения в сеть 220в.

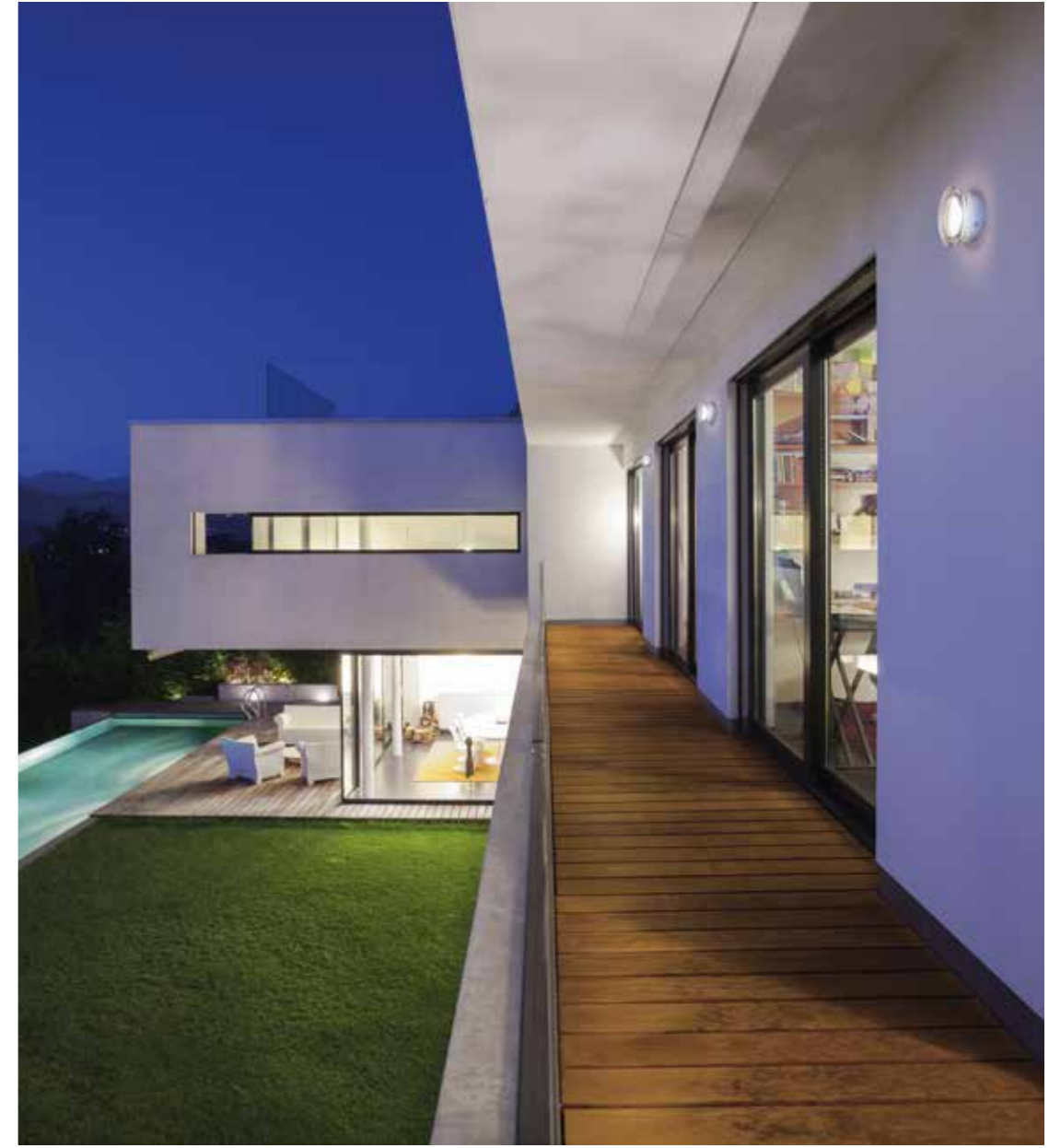
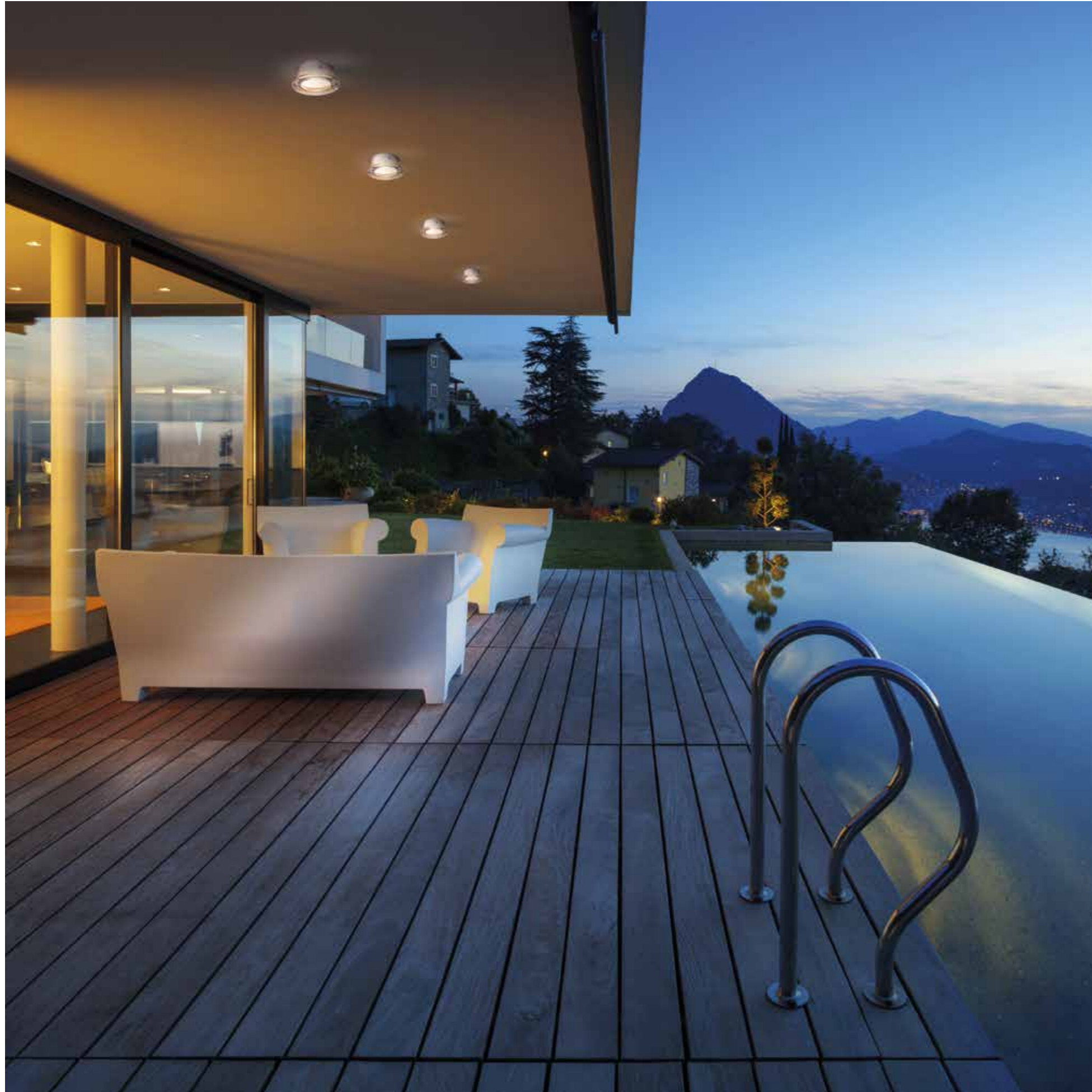

Sistema d'illuminazione lineare con sorgente LED per installazione a parete, soffitto e sospensione. Corpo in estruso d'alluminio verniciato bianco, dimensionato per poter contenere gli alimentatori. Diffusore in policarbonato opalino.

Partendo da singoli segmenti luminosi è possibile creare innumerevoli composizioni modulari grazie alla disponibilità di snodi e giunti studiati per ogni possibile necessità.

Linear lighting system fitted with LED technology, for wall, ceiling and suspended use.

White painted extruded aluminum profile sized to integrate power supplies.

Diffuser in opal polycarbonate.

Starting from individual lighted segments you can create countless modular compositions thanks to the availability of a number of joints for any kind of installation.

Système d'éclairage linéaire équipé de technologie LED pour installation à mur, plafond et suspension.

Profilé d'aluminium extrudé verni blanc, dimensionné pour pouvoir contenir les convertisseurs.

Diffuseur en polycarbonate opalin.

En Partant de simples segments lumineux, c'est possible de créer d'innombrables compositions modulaires grâce à la disponibilité de différents joints pour chaque type d'installation.

Lineares Beleuchtungssystem mit LED-Modulen, für Wand-/Deckenmontage oder Aufhängung.

Weiß lackiertes Aluminiumprofil mit integriertem Konverter. Diffusor aus opalen Polykarbonat.

Die einzelnen Lichtsegmente können mit verschiedenen Verbindern modular zu beliebigen Formen zusammengefügt und montiert werden.

Sistema de iluminación linear a pared, techo y suspensión equipado con tecnología LED.

Perfil en extrusión de aluminio pintado blanco dimensionado para contener los convertidores.

Difusor de policarbonato opalino.

Partendo desde segmentos luminosos individuales se pueden crear innumerables composiciones modulares gracias a la disponibilidad de articulaciones diseñadas para cualquier tipo de instalación.

Линейная светодиодная система для установки на стену, потолок или с подвесом. Окрашенный в белый цвет экструзионный алюминиевый профиль со встроенным конвертером.

Диффузор из матового поликарбонат. Из отдельных сегментов можно создавать бесконечные модульные композиции благодаря имеющимся многочисленным соединительным элементам.



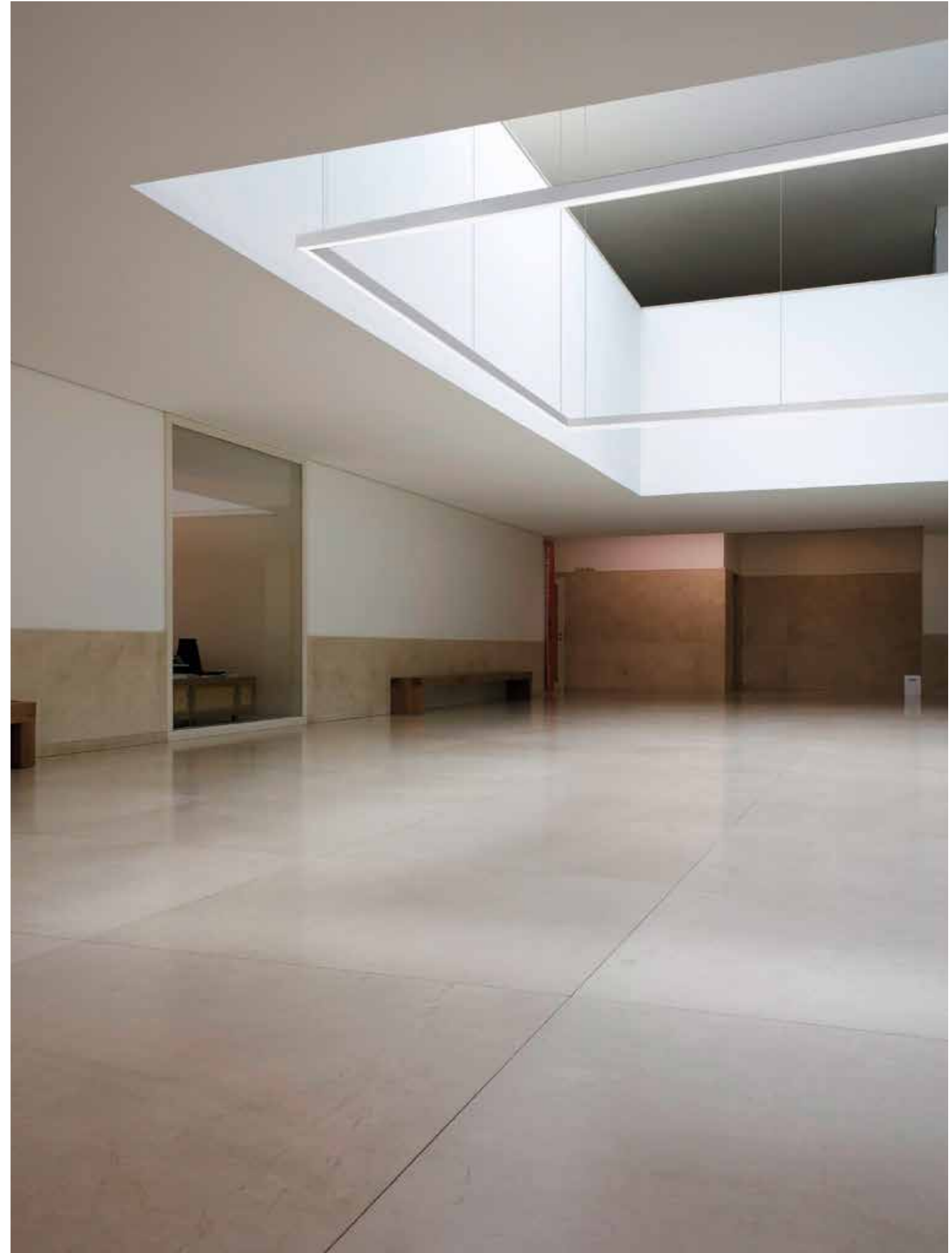
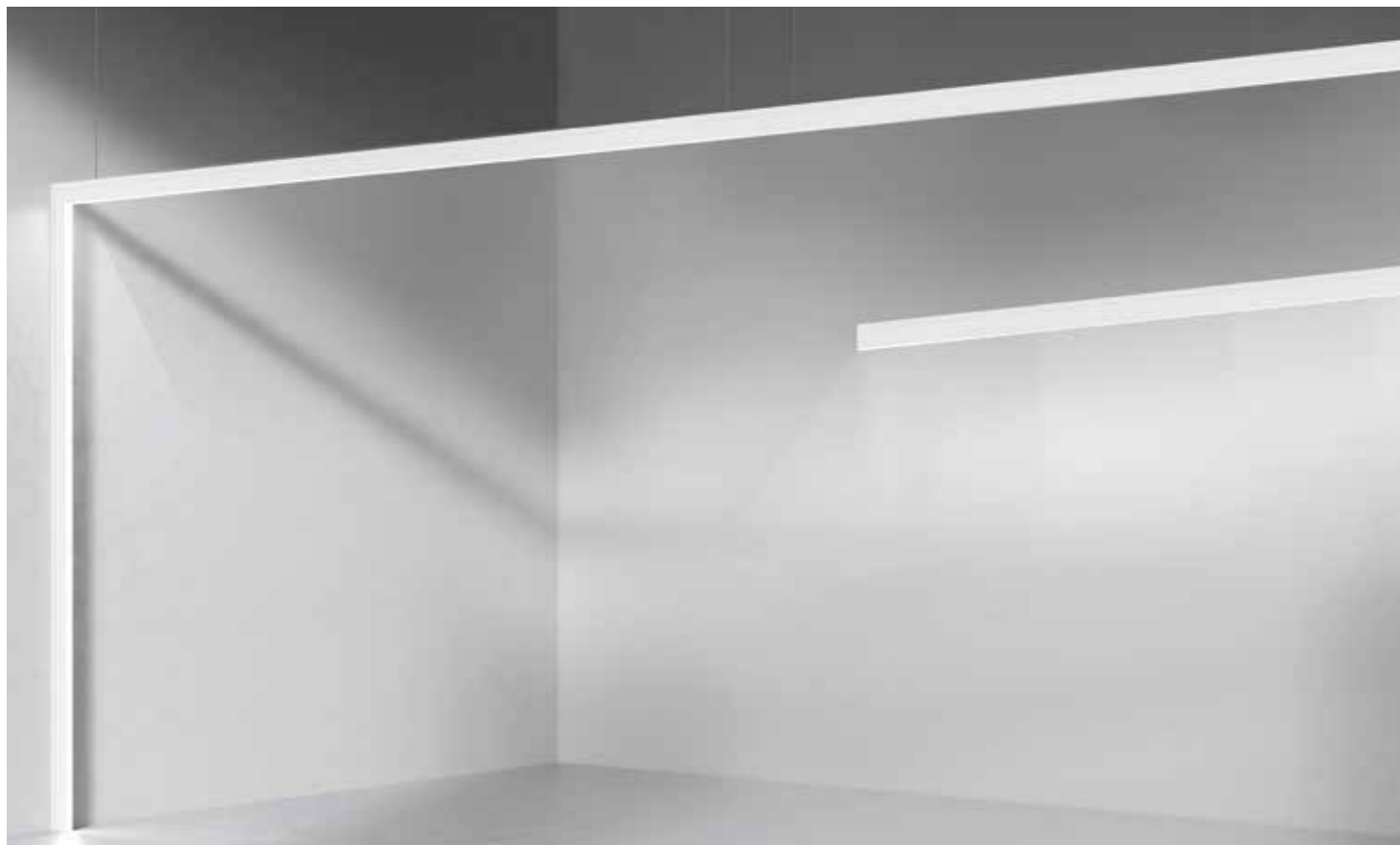

Sospensioni - Suspensions



Aerostat 82



Alea 110



Baloon 98



Bibox 128



Desk-Desk Maxi 124



Pool 96



Prêt à Porter 106



Rail 66



Rulò 108



Seta 136



Fokus 114



Giara 86



Kappa 72



Lancia 62



Liola 138



Spirits 58



Trifoglio 134



Llum 130



Lui Lei 76



Matassa 102



Maya 140



Megavide 52



Milady 100



Mir 142



Mork 88



Phantom 118



Phantom Maxi 122

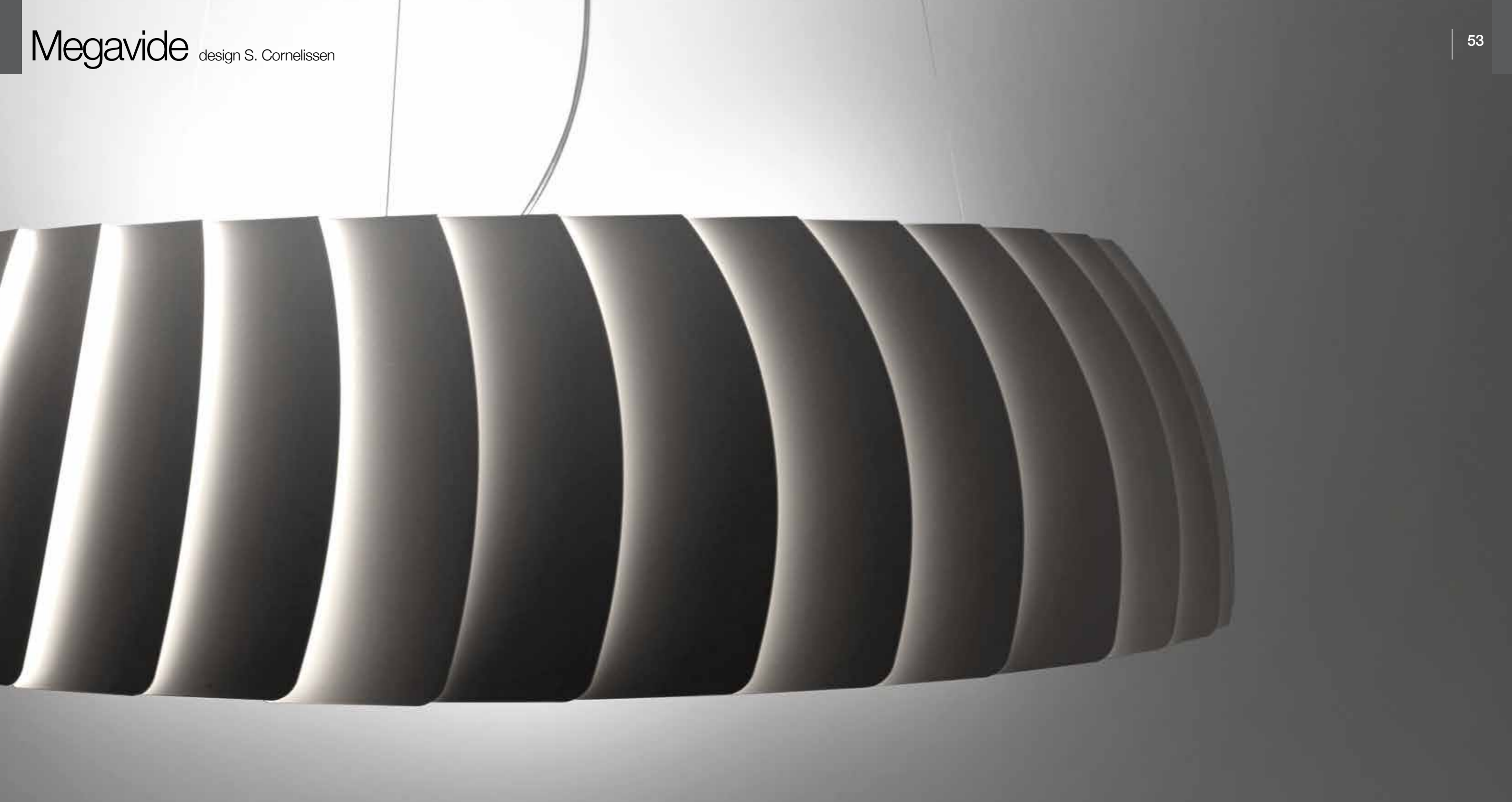

Lampade a sospensione o soffitto di grandi dimensioni dotate di sorgente LED. Struttura ed elementi modulari del diffusore sono realizzati in alluminio verniciato. Le versioni a soffitto sono dotate di un disco bianco ri-verniciabile per nascondere l'alimentatore e simulare l'effetto di un apparecchio a scomparsa. Alimentatore incluso.

Large Suspensions or ceiling lamps fitted with LED light engine. Structure and modular elements of the shade realized in painted aluminum. Ceiling version includes a white re-paintable panel to hide converter and simulate the effect of a recessed fixture. Converter on board.

Suspensions ou lampes à plafond de grandes dimensions équipés avec des sources LED. Structure et éléments modulaires du diffuseur réalisés en aluminium verni. Les versions à plafond incluent un panneau blanc qui peut être peint pour cacher le convertisseur et simuler l'effet d'un luminaire encastré. Convertisseur inclus.

Großformatige Pendel- oder Deckenleuchten mit LED Technik. Struktur und modulare Elemente des Schirms aus lackiertem Aluminium. Die Deckenleuchten werden mit einem weißen, lackierbaren Panel zur Abdeckung des Konverters geliefert (gleicher Effekt wie bei Einbau). Inklusive Konverter.

Lámparas colgantes o de techo de grande diámetro equipadas con fuente de luz LED. Estructura y elementos modulares de la sombra realizados en aluminio pintado. Versión de techo incluye un panel blanco repintable para ocultar el convertidor y simular el efecto de un aparato empotrado. Convertidor incluido.

Большой подвесной или потолочный светильник на светодиодах. Структура и детали из окрашенного алюминия. Потолочные модели с окрашиваемой панелью, за которой прячется конвертер. Конвертер включен.

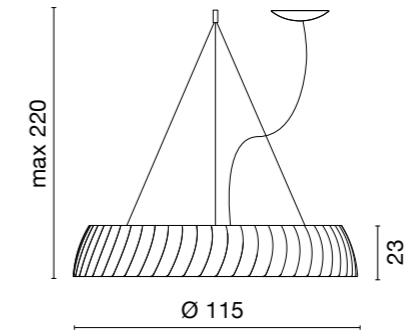

1532 4,5 kg
/ww Led 45W 5790lm 3000K
F
.01/WW

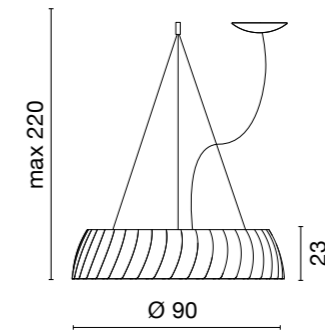
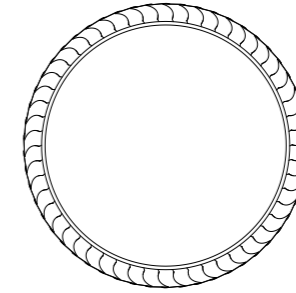

1531 3,5 kg
/ww Led 33W 4246lm 3000K
F
.01/WW

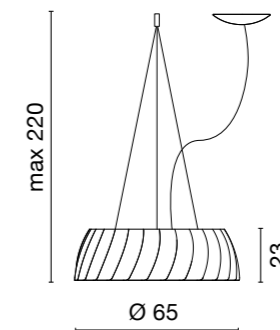
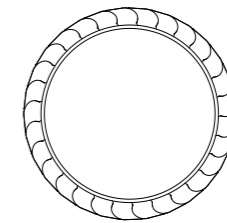

1530 2,5 kg
/ww Led 22,5W 2895lm 3000K
F
.01/WW

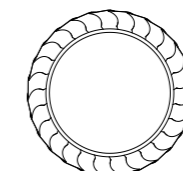





Lampade a sospensione realizzate in alluminio. Un design innovativo che, rivisitando forme classiche, inventa per esse nuove funzioni ed effetti.

L'insolito posizionamento delle sorgenti LED nella parte bassa dell'apparecchio crea riflessi e proiezioni di luce inattese. Disponibile nelle finiture: Bianco, Nero/foglia oro. Rosoni o piastre con alimentatore incluso da ordinare separatamente.

Pendant lamps made of aluminium. An innovative design that revisits classic shapes inventing for them new functions and effects. The unusual positioning of the LED sources in the lower part of the unit creates unexpected light reflections and projections. Available in white or black/gold leaf. Canopy or fixing plates including converter are sold separately.

Suspension en aluminium. Un design innovant qui, revisitant des formes classiques, invente de nouvelles fonctions et effets. Le positionnement inhabituelle des sources LED dans la partie inférieure de l'appareil crée des réflexions et des projections de lumière inattendus. Disponible en blanc ou noir/feuille d'or. Rosace ou plaque de fixation avec convertisseur inclus à commander séparément.

Pendelleuchte aus Metall. Ein innovatives Design, das klassische Linien aufgreift und sie mit neuen Funktionen und Effekten verbindet. Die außergewöhnliche Positionierung der LEDs im unteren Teil des schafft unerwartete Lichtreflexionen und Projektionen. Erhältlich in weiß oder schwarz/Blattgold. Baldachin oder montageplatte inklusive Konverter separat bestellen.

Colgante de metal. Un diseño innovador que revisita formas clásicas inventando por esas nuevas funciones y efectos. El posicionamiento inusual de las fuentes de luz LED en la parte baja de la unidad crea reflejos de luz y proyecciones inesperadas. Disponible en acabado blanco o negro/hoja de oro. Baldachin o placas de anclaje con convertidor incluido a pedir por separado.

Серия подвесных светильников из металла. Инновационный дизайн придает классическим формам новые функции и эффекты. Необычное расположение светодиодов в нижней части светильника создает неожиданные отражения и проекции света. Цвета: белый или черный/золотой лист. Конвертер включен.

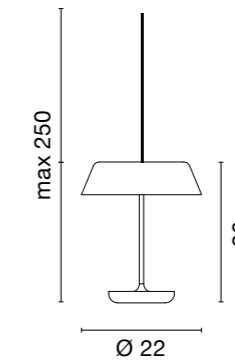

1535 1 kg
Led 13,2W 1900lm 3000K
F III 250 cm
.01/WW .02.29/WW

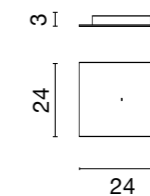

0951 1 kg
Rosone completo di alimentatore - 1 Spirits
Ceiling rose with converter - 1 Spirits
230V
F III
.01 .02

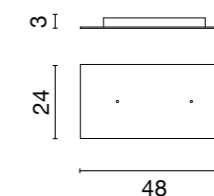

0952 2 kg
Rosone completo di alimentatore - 2 Spirits
Ceiling rose with converter - 2 Spirits
230V
F III
.01 .02

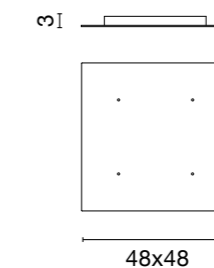

0953 3,8 kg
Rosone completo di alimentatore - 4 Spirits
Ceiling rose with converter - 4 Spirits
230V
F III
.01 .02

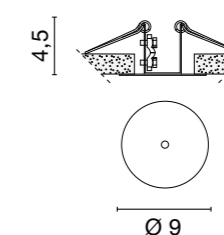

0954 0,7 kg
Rosone per cartongesso con alimentatore - 1 Spirits
Plasterboard ceiling rose with converter - 1 Spirits
F III
.01 7,5 cm.



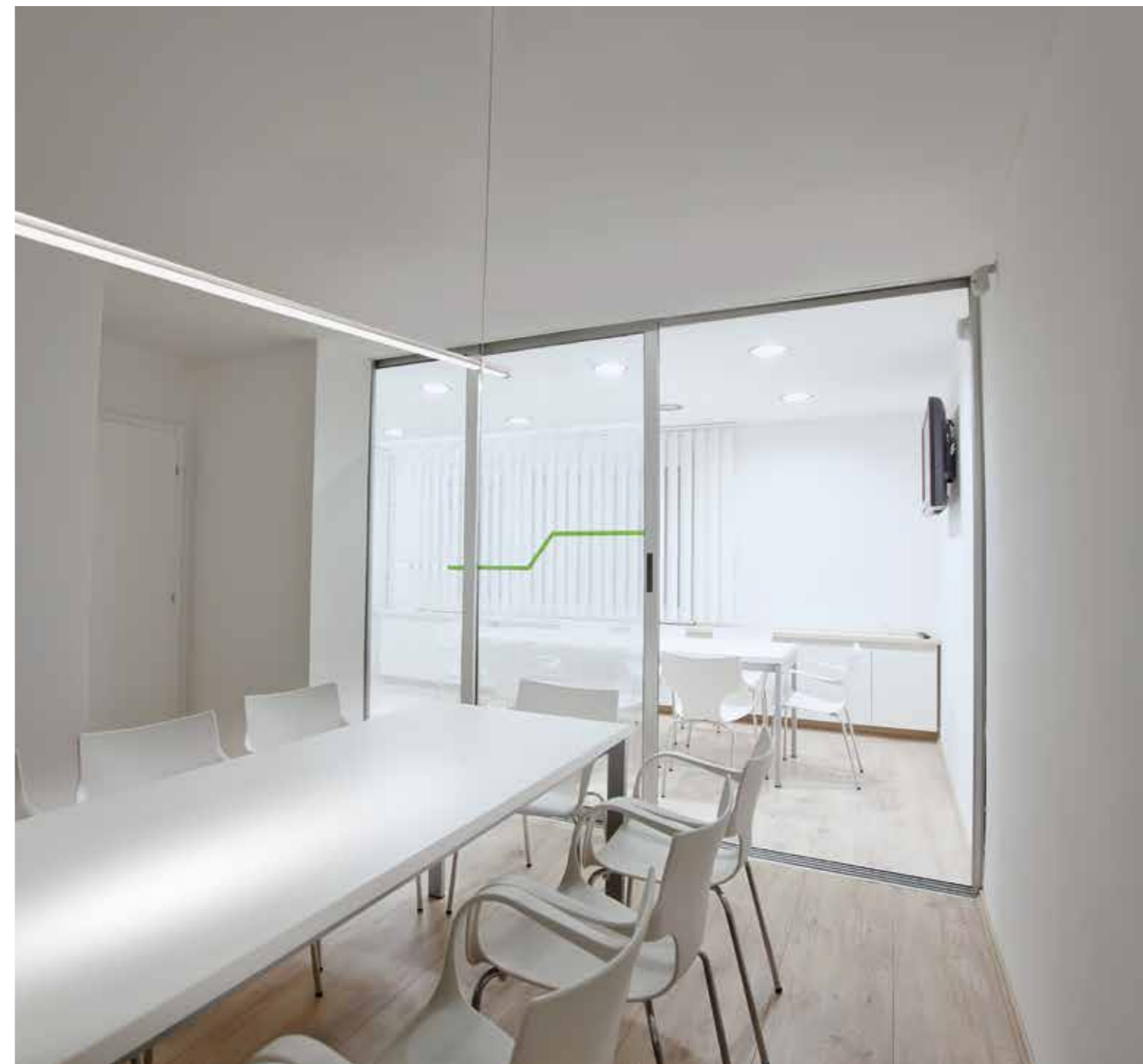
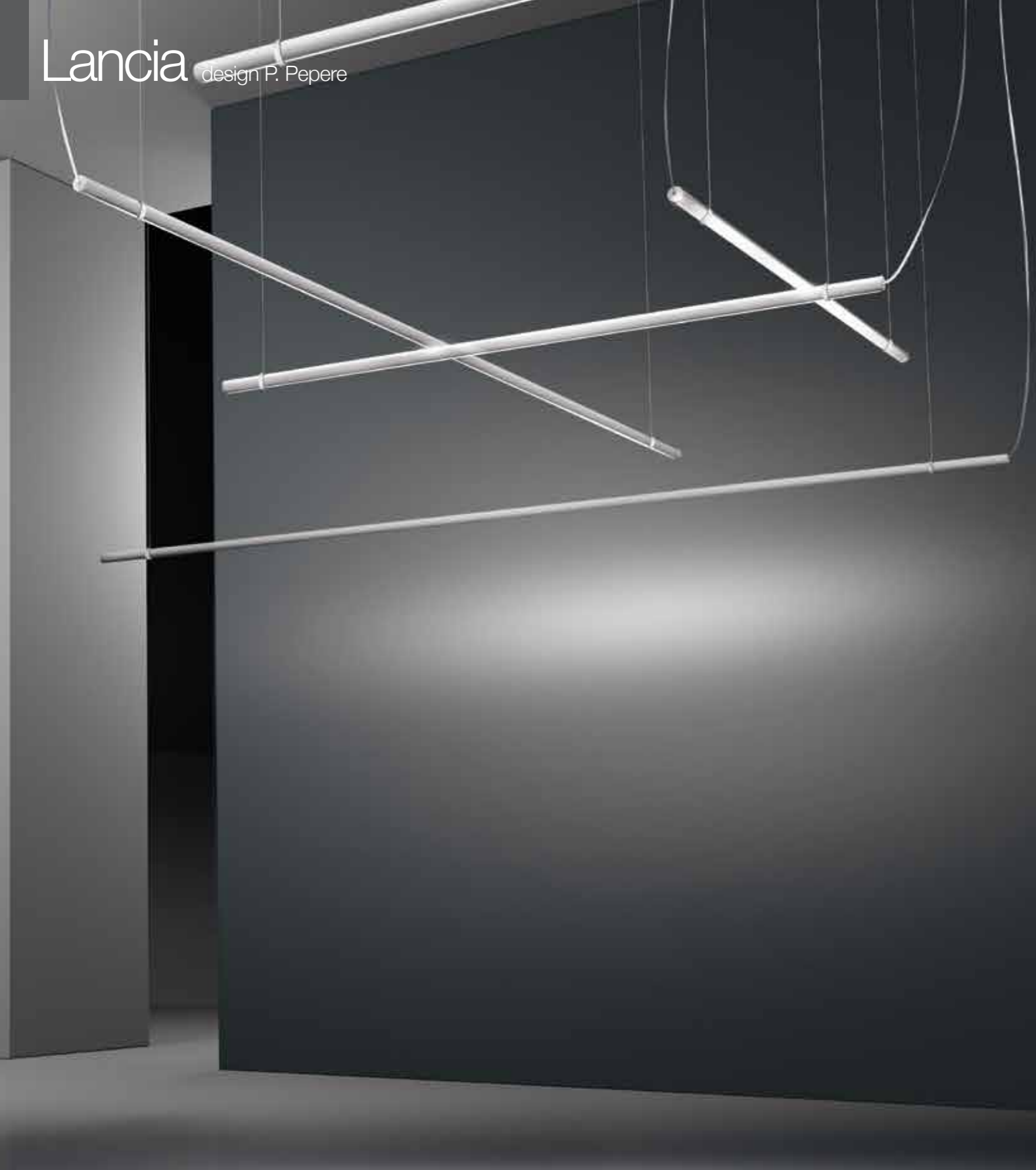

Serie di lampade orientabili a sospensione.
Struttura in alluminio verniciato bianco, diffusore in metacrilato satinato.

Le versioni a sospensione sono realizzabili, a richiesta, in misure speciali modulari.

Adjustable suspension lamps.
Structure in white painted aluminum and satin methacrylate diffuser.
Suspended versions are available, upon request, in modular special lengths.

Lampe réglable à suspension.
Structure en aluminium laqué blanc et diffuseur en méthacrylate satiné.

La version lampadaire est doué d'une patère
Les versions suspension sont disponibles, sur requête, dans des longueurs modulaires spéciaux.

Serie von Pendeleuchten.
Struktur aus weiß lackiertem Aluminium und Diffusor aus satiniertem Acrylglas.
Pendelversionen sind, auf Anfrage, auch in modularen Sonderlängen lieferbar.

Serie de colgantes ajustables.
Estructura de aluminio pintado blanco y difusor de metacrilato satinado.

Las versiones suspendidas están disponibles, previa solicitud, en medidas modulares especiales.

Серия настенных, подвесных или напольных поворотных светильников.
Корпус из окрашенного алюминия, диффузор матовый метакрилат. Подвесные варианты могут быть исполнены по запросу в других размерах.

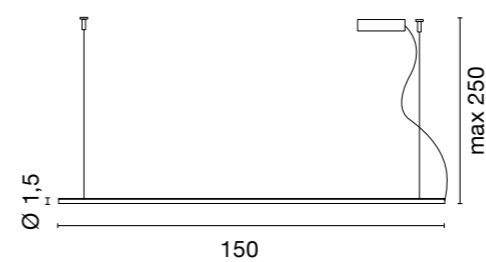

1540 1,5 kg

Led 27W 3570lm 3000K



.01/WW



SU MISURA - CUSTOM SIZE

Tabella lunghezze disponibili a richiesta.
Table of available lengths on request.

cm.	watt	warm white 3000K(WW)	lm
100	18W	A1540.01/100/WW	2380
125	22,5W	A1540.01/125/WW	2975
150	27W	1540.01/WW *	3570
175	31,5W	A1540.01/175/WW	4165
200	36W	A1540.01/200/WW	4760
225	40,5W	A1540.01/225/WW	5355
250	45W	A1540.01/250/WW	5950
275	49,5W	A1540.01/275/WW	6545
300	54W	A1540.01/300/WW	7140

* Articolo standard a catalogo

* Standard catalogue item



SU MISURA - CUSTOM SIZE

Tabella lunghezze disponibili a richiesta.
Table of available lengths on request.

cm.	watt	white 4000K (W)	lm	warm white 3000K (WW)	lm
62	9W	A1541.01/60/W	1230	A1541.01/60/WW	1188
72	10,5W	A1541.01/70/W	1436	A1541.01/70/WW	1386
82	12W	1541.01/W *	1641	1541.01/WW *	1584
92	13,5W	A1541.01/90/W	1846	A1541.01/90/WW	1782
102	15W	A1541.01/100/W	2051	A1541.01/100/WW	1980
112	16,5W	A1541.01/110/W	2256	A1541.01/110/WW	2178
122	18W	A1541.01/120/W	2461	A1541.01/120/WW	2376
132	19,5W	A1541.01/130/W	2666	A1541.01/130/WW	2574
142	21W	A1541.01/140/W	2871	A1541.01/140/WW	2772
152	22,5W	1542.01/W *	3076	1542.01/WW *	2970
162	24W	A1541.01/160/W	3282	A1541.01/160/WW	3168
172	25,5W	A1541.01/170/W	3487	A1541.01/170/WW	3366
182	27W	A1541.01/180/W	3692	A1541.01/180/WW	3564
192	28,5W	A1541.01/190/W	3897	A1541.01/190/WW	3762
202	30W	A1541.01/200/W	4102	A1541.01/200/WW	3960
212	31,5W	A1541.01/210/W	4307	A1541.01/210/WW	4158
222	33W	A1541.01/220/W	4512	A1541.01/220/WW	4356
232	34,5W	A1541.01/230/W	4717	A1541.01/230/WW	4554
242	36W	A1541.01/240/W	4922	A1541.01/240/WW	4752
252	37,5W	A1541.01/250/W	5128	A1541.01/250/WW	4950
262	39W	A1541.01/260/W	5333	A1541.01/260/WW	5148
272	40,5W	A1541.01/270/W	5538	A1541.01/270/WW	5346
282	42W	A1541.01/280/W	5743	A1541.01/280/WW	5544
292	43,5W	A1541.01/290/W	5948	A1541.01/290/WW	5742
302	45W	A1541.01/300/W	6153	A1541.01/300/WW	5940

* Articolo standard a catalogo
* Standard catalogue item

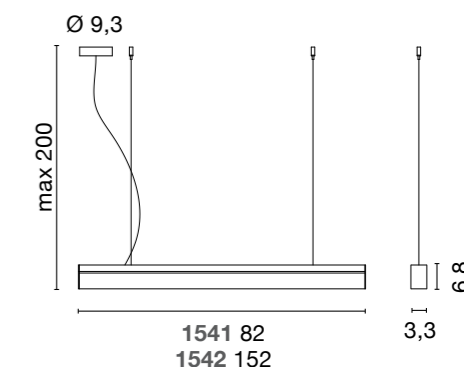

1541

1,1 kg

1542

1,5 kg

/W Led 12W 1641lm 4000K

/W Led 22,5W 3076lm 4000K

/WW Led 12W 1584lm 3000K

/WW Led 22,5W 2970lm 3000K



.01/W .01/WW



.01/W .01/WW

Sospensioni lineari con sorgente LED. Corpo in estruso d'alluminio verniciato bianco, dimensionato per poter contenere gli alimentatori. Doppia emissione disponibile su richiesta.

Linear suspensions with LED technology. White painted extruded aluminum profile sized to integrate power supplies. Double emission available upon request.

Supensions linéaires équipés de technologie LED. Profilé d'aluminium extrudé verni blanc, dimensionné pour pouvoir contenir les convertisseurs. Double mission disponible sur requête.

Lineares Pendelleuchten mit LED-Modulen. Weiß lackiertes Aluminiumprofil mit integriertem Konverter. Zweiseitige Ausstrahlung auf Anfrage.

Suspensión lineares con tecnología LED. Perfil en extrusión de aluminio pintado blanco dimensionado para contener los convertidores. Doble emisión disponible bajo petición.

Линейная светодиодная система для установки на стену, потолок или с подвесом. Окрашенный в белый цвет экструзионный алюминиевый профиль со встроенным конвертером. Вариант с лучом вверх/вниз по запросу.



SU MISURA - CUSTOM SIZE

Tabella lunghezze disponibili a richiesta.
Table of available lengths on request.

cm.	watt	white 4000K (W)	lm	warm white 3000K (WW)	lm
61,5	9W	A1543.01/60/W	1230	A1543.01/60/WW	1188
71,5	10,5W	A1543.01/70/W	1436	A1543.01/70/WW	1386
81,5	12W	1543.01/W *	1641	1543.01/WW *	1584
91,5	13,5W	A1543.01/90/W	1846	A1543.01/90/WW	1782
101,5	15W	A1543.01/100/W	2051	A1543.01/100/WW	1980
111,5	16,5W	A1543.01/110/W	2256	A1543.01/110/WW	2178
121,5	18W	A1543.01/120/W	2461	A1543.01/120/WW	2376
131,5	19,5W	A1543.01/130/W	2666	A1543.01/130/WW	2574
141,5	21W	A1543.01/140/W	2871	A1543.01/140/WW	2772
151,5	22,5W	1544.01/W *	3076	1544.01/WW *	2970
161,5	24W	A1543.01/160/W	3282	A1543.01/160/WW	3168
171,5	25,5W	A1543.01/170/W	3487	A1543.01/170/WW	3366
181,5	27W	A1543.01/180/W	3692	A1543.01/180/WW	3564
191,5	28,5W	A1543.01/190/W	3897	A1543.01/190/WW	3762
201,5	30W	A1543.01/200/W	4102	A1543.01/200/WW	3960
211,5	31,5W	A1543.01/210/W	4307	A1543.01/210/WW	4158
221,5	33W	A1543.01/220/W	4512	A1543.01/220/WW	4356
231,5	34,5W	A1543.01/230/W	4717	A1543.01/230/WW	4554
241,5	36W	A1543.01/240/W	4922	A1543.01/240/WW	4752
251,5	37,5W	A1543.01/250/W	5128	A1543.01/250/WW	4950
261,5	39W	A1543.01/260/W	5333	A1543.01/260/WW	5148
271,5	40,5W	A1543.01/270/W	5538	A1543.01/270/WW	5346
281,5	42W	A1543.01/280/W	5743	A1543.01/280/WW	5544
291,5	43,5W	A1543.01/290/W	5948	A1543.01/290/WW	5742
301,5	45W	A1543.01/300/W	6153	A1543.01/300/WW	5940

* Articolo standard a catalogo
* Standard catalogue item

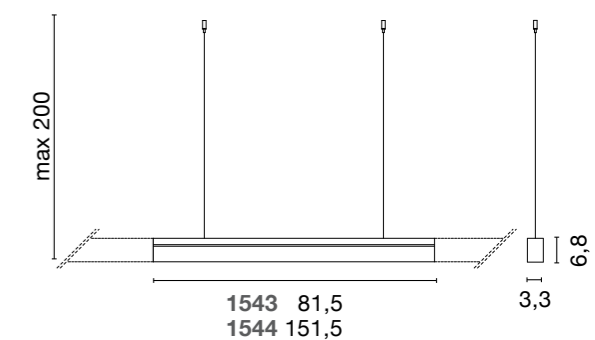

1543

/W Led 12W 1641lm 4000K

/WW Led 12W 1584lm 3000K

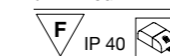

.01/W .01/WW

1544

/W Led 22,5W 3076lm 4000K

/WW Led 22,5W 2970lm 3000K

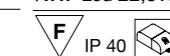

.01/W .01/WW

1,4 kg

Sistema d'illuminazione lineare con sorgente LED per installazione a parete, soffitto e sospensione. Corpo in estruso d'alluminio verniciato bianco, dimensionato per poter contenere gli alimentatori.

Partendo da singoli segmenti luminosi è possibile creare innumerevoli composizioni modulari grazie alla disponibilità di snodi e giunti studiati per ogni possibile necessità.

Linear lighting system fitted with LED technology, for wall, ceiling and suspended use. White painted extruded aluminum profile sized to integrate power supplies. Starting from individual lighting segments you can create countless modular compositions thanks to the availability of a number of joints for any kind of installation.

Système d'éclairage linéaire équipé de technologie LED pour installation à mur, plafond et suspension. Profilé d'aluminium extrudé vernicié blanc, dimensionné pour pouvoir contenir les convertisseurs. À partir de segments d'éclairage individuels, c'est possible de créer d'innombrables compositions modulaires grâce à la disponibilité de différents joints pour chaque type d'installation.

Sistema de iluminación lineal a pared, techo y suspensión equipado con tecnología LED. Perfil en extrusión de aluminio pintado blanco dimensionado para contener los convertidores. A partir de segmentos luminosos individuales se pueden crear innumerables composiciones modulares gracias a la disponibilidad de articulaciones diseñadas para cualquier tipo de instalación.

Lineares Beleuchtungssystem mit LED-Modulen, für Wand-/Deckenmontage oder Aufhängung. Weiß lackiertes Aluminiumprofil mit integriertem Konverter.

Die einzelnen Lichtsegmente können mit verschiedenen Verbindern modular zu beliebigen Formen zusammengefügt und montiert werden.

Линейная светодиодная система для установки на стену, потолок или с подвесом. Окрашенный в белый цвет экструзионный алюминиевый профиль со встроенным конвертером. Из отдельных сегментов можно создавать бесконечные модульные композиции благодаря имеющимся многочисленным соединительным элементам.

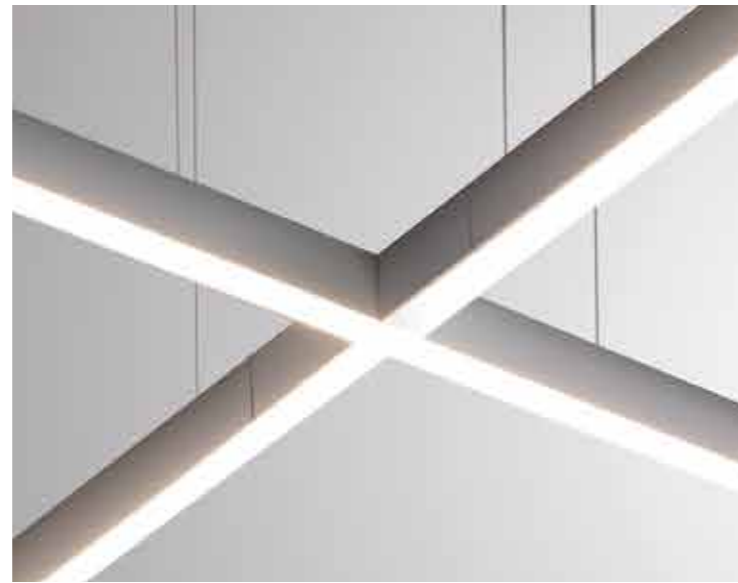

Angolo 90°
90° Corner

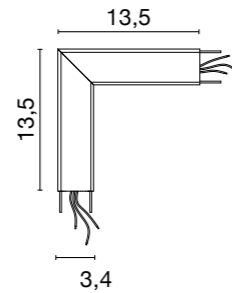

0941 0,4 kg
 /W Led 3W 410lm 4000K
 /WW Led 3W 396lm 3000K
 F
 .01/W .01/WW



Rosone completo di cavo
di alimentazione
Ceiling rose with cable

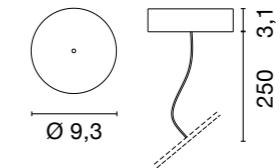

0946 0,08 kg
 .01



Giunzione a croce
Cross joint

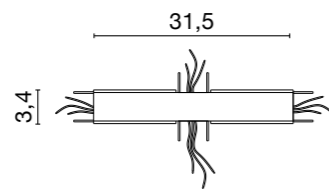

0943 0,35 kg
 /W Led 4,5W 615lm 4000K
 /WW Led 4,5W 594lm 3000K
 F
 .01/W .01/WW



Schermo
Shade

0948/200
 Schermo 200cm
0948/300
 Schermo 300cm



Giunzione a T
T joint

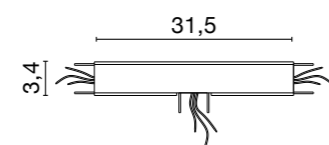

0942 0,35kg
 /W Led 4,5W 615lm 4000K
 /WW Led 4,5W 594lm 3000K
 F
 .01/W .01/WW



Piastra con molle
per controsoffitti.
Ceiling plate with springs.

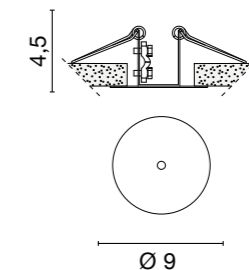

0947 0,07 kg
 .01 7,5 cm.



Raccordo parete - plafone
Wall-ceiling joint

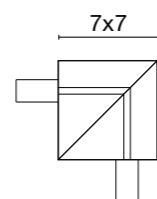

0944 0,15 kg
 .01



2 testate di chiusura.
2 closing heads.

0945
 .01



Lampade a sospensione e a soffitto/parete in alluminio verniciato bianco e diffusore in metacrilato satinato termoformato. Accessorio di fissaggio in alluminio per installazione angolata e rotazione delle versioni parete/soffitto, art. 0172.01

Pendant and ceiling/wall lamps in white finished aluminum with satin thermoformed methacrylate diffuser. Accessory aluminum bracket allowing angled fixing and rotation for ceiling/wall versions, art. 0172.01

Suspension et plafonnier/applique en aluminium verni blanc avec écran diffuseur en méthacrylate satiné thermoformé. Accessoire pivot en aluminium pour fixation anglée et rotation des appareils applique/plafonnier, art. 0172.01

Pendel- sowie Wand- und Deckenleuchten aus Weiß lackiertem Aluminium. Diffusor aus satiniertem Acrylglas. Befestigungszubehör für drehbare und abgewinkelte Montage der Wand-/Deckenleuchte, Art. 0172.01.

Lampara de techo/pared y colgante de aluminio pintado blanco, difusor de metacrilato satinado. Accesorio de anclaje en aluminio para instalación angular y rotación del modelo techo/pared, art. 0172.01

Подвесной и потолочный/настенный светильники, корпус из алюминия, окрашенного в белый цвет, рассеиватель из термоформированного матового метакрилата. Как аксессуар алюминиевый поворотный кронштейн для потолочной/настенной модели, арт. 0172.01

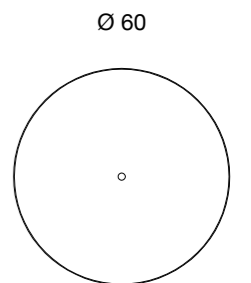
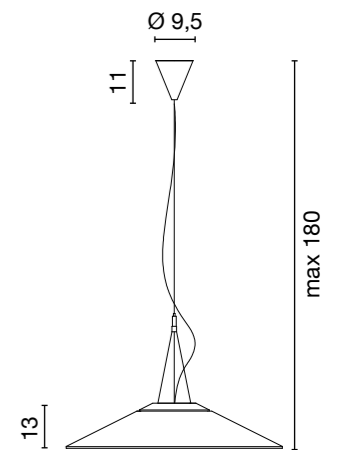

1512 led 4,2 kg

Led 32,6W 3950 lm 3000K

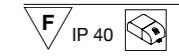

.01

1513 fluo 4 kg

55W 2GX13

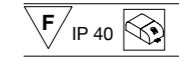

.01



Lampade a sospensione in vetro soffiato con finitura a smalto in doppio colore.
Disponibili in due dimensioni.

Suspensions in blown bicolor enameled glass. Available in two dimensions.

Lampes à suspension en verre soufflé et émaillé en double couleur.
Disponibles en deux tailles.

Pendelleuchten aus geblasenem-Glas, zweifarbige Emaillierung.
Erhältlich in zwei Größen.

Colgantes de vidrio soplado y esmaltado en doble color. Dos tamaños disponibles.

Подвесные светильники из дутого стекла, окрашенного глянцевой эмалью. С разной окраской внутри и снаружи. В двух размерах.



1514	0,9 kg
50W GU10	
9W GU10 Fluo EL	
8W GU10 Led (cod. 0104)	
5,5W GU10 Led (cod. 0094)	
F	
.01 .02 .06 .09 .12 .13	

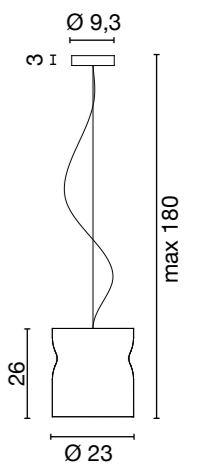

- 1515** 2,1 kg
- 52W E27 ECO
- 16W E27 Fluo EL
- 10W E27 Led (cod. 0105)
- 16W E27 PAR30 Led (cod. 0106)





Sospensione in alluminio verniciato bianco per luce diretta e indiretta. Doppia accensione

Aluminum suspension, white finish, direct and indirect light. Double switching.





Suspension en aluminium verni blanc avec lumière directe et indirecte. Double allumage

Pendelleuchte aus weiß lackiertem Aluminium für direktes und indirektes Licht. Doppelschaltung.

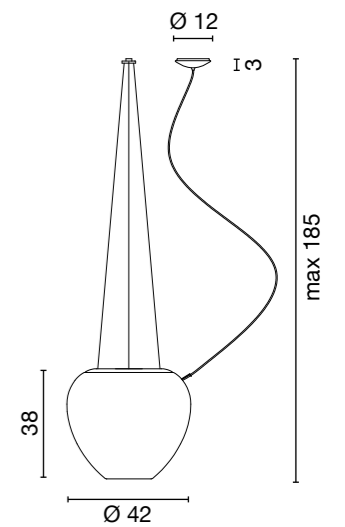
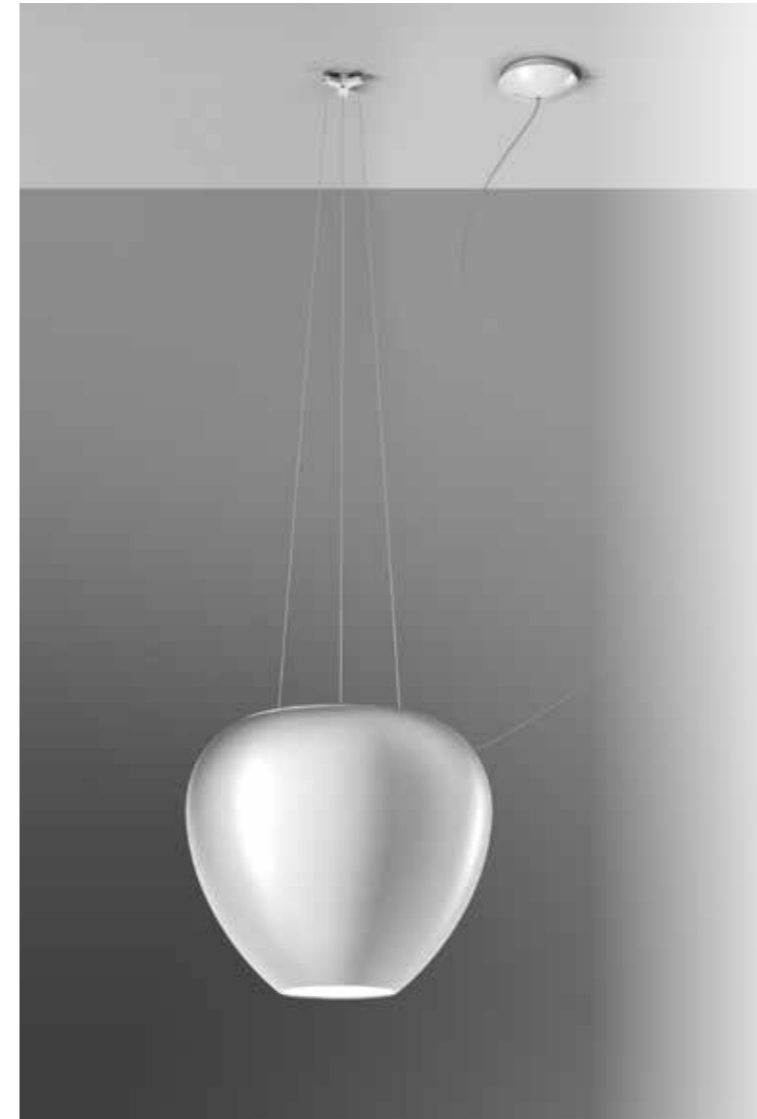
Lampara colgante de aluminio pintado de blanco por luz directa y indirecta. Doble encendido

Подвесной светильник направленного и рассеянного освещения (могут включаться вместе или по отдельности), корпус выполнен из алюминия, окрашенного в белый цвет.



1521 4,2 kg
indirect light: Led 17,5W 1550lm 3000K (included)
direct light:
 75W E27 PAR30 
 24W E27 Fluo EL 
 16W E27 PAR30 Led (cod. 0106) 
 
 .01

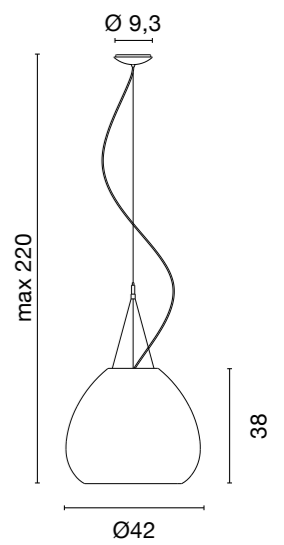

Sospensione in alluminio verniciato bianco a luce diffusa. Schermo diffusore in metacrilato satinato.

Suspension en aluminium verni blanc avec lumière directe. Diffuser en méthacrylate satiné.

Colgante de luz directa de aluminio pintado de blanco. Pantalla de metacrilato satinado.

Aluminum suspension, white finish, direct light. Satin methacrylate diffuser.

Pendelleuchte in weiß lackiertem Aluminium mit direktem Licht. Diffusor aus satiniertem Metacrylat.

Подвесной светильник рассеянного освещения, корпус выполнен из окрашенного алюминия. Рассеиватель из матового метакрилата.

1523	3,3 kg
70W E27 ECO	
30W E27 Fluo EL	
10W E27 Led (cod. 0105)	



Lampada o sistema d'illuminazione a sospensione componibile. Corpi in alluminio verniciato bianco. Rosone sistema con alimentatore per max. 6 elementi.(art. 0506)

Suspension and modular lighting system. White painted aluminum body. System ceiling canopy with converter for max 6 pcs.(art. 0506)

Suspension et système d'éclairage composable suspendu. Corps en aluminium verni blanc. Rosace système avec alimentateur pour max 6 lampes (art. 0506)

Pendelleuchte sowie Modulares Beleuchtung-System zur Abhängung. Leuchtkörper aus weiß lackiertem Aluminium. System-Baldachin mit Konverter max. 6 Einheiten (art. 0506)

Sistema de iluminación modular a colgantes.Cuerpo de aluminio pintado blanco. Baldaquín sistema con convertidor hasta 6 piezas (art. 0506)

Подвесная модульная система. Корпус из алюминия,окрашенного в белый цвет. Потолочная база с конвертером для максимум 6 светильников. (арт. 0506)

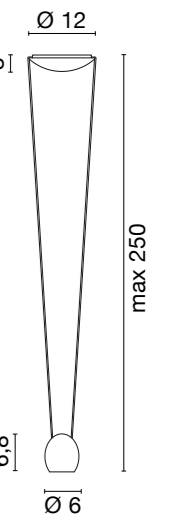
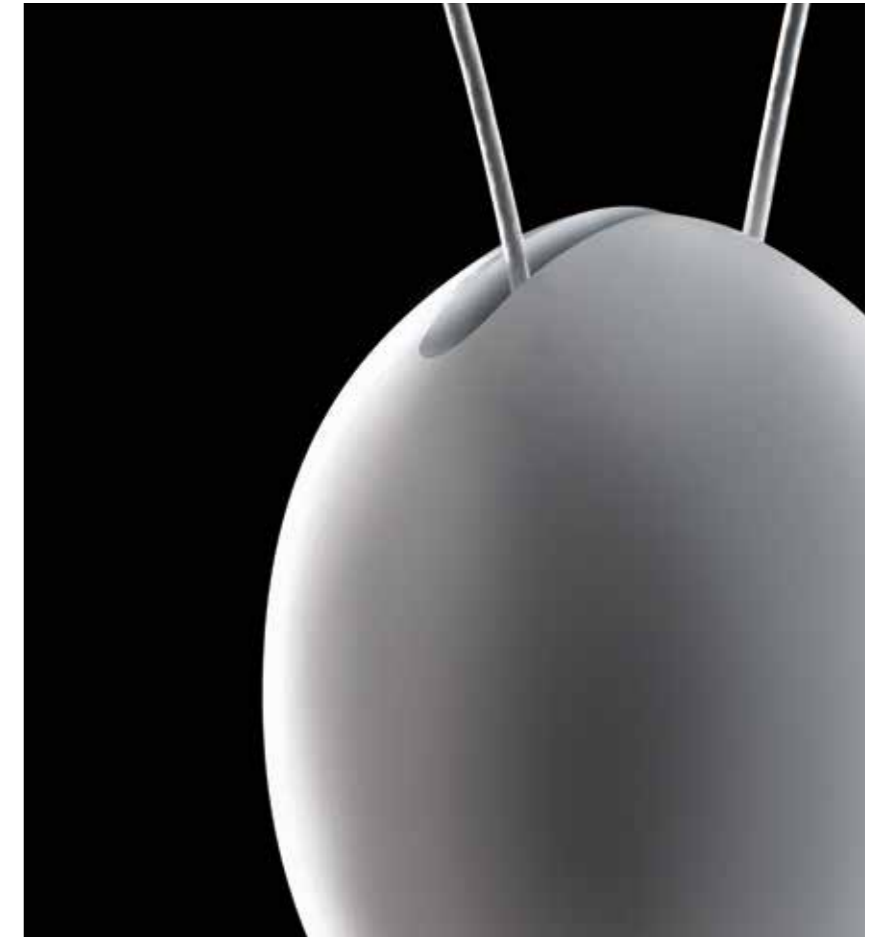

1507 0,7 kg

Led 1050 mA (3,4W) 350lm 3000K



Legenda

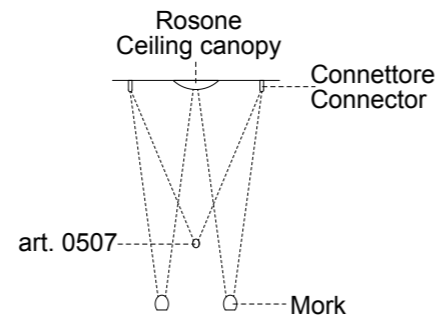
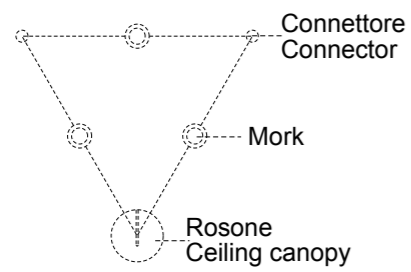

Esempi di installazione geometriche - Examples of geometric configuration

3 MORK

3 art. 1506
Mork (connector included)
+
1 art. 0506
Rosone - Ceiling canopy

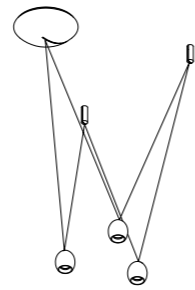
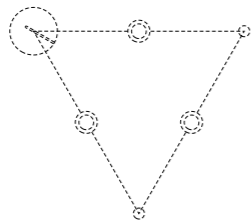

4 MORK

4 art. 1506
Mork (connector included)
+
1 art. 0506
Rosone - Ceiling canopy

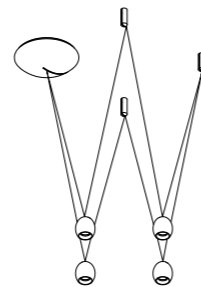
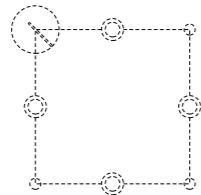

5 MORK

5 art. 1506
Mork (connector included)
+
1 art. 0506
Rosone - Ceiling canopy

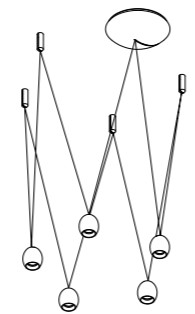
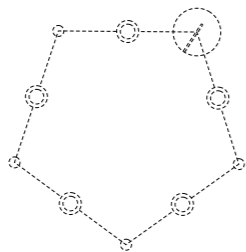

6 MORK

6 art. 1506
Mork (connector included)
+
1 art. 0506
Rosone - Ceiling canopy

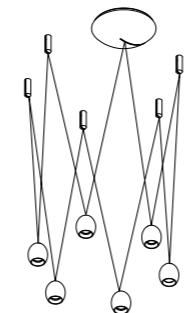
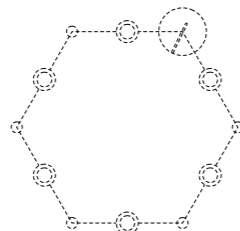

1506 0,45 kg
Led max 1400 mA (4,5W) 450 lm DC 3000K
F III 250 cm
.01

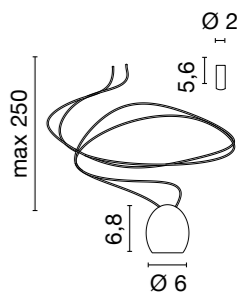

0506 0,7 kg
Rosone completo di alimentatore - max 6 Mork
Ceiling canopy with converter - max 6 Mork
230V
F
.01

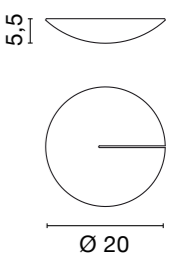

SOLO COLLEGAMENTO IN SERIE - ONLY SERIAL CONNECTION

Esempi di installazione in linea - Examples for in linear configuration

2 MORK

2 art. 1506
Mork (connector included)
+
1 art. 0506
Rosone - Ceiling canopy
+
1 art. 0507
Collegamento per configurazioni lineari da 2,4,6 Mork.
Accessory for linear configuration
2, 4 or 6 Mork.

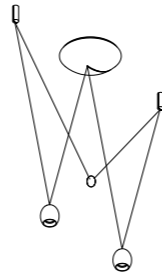
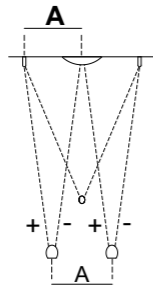

3 MORK

3 art. 1506
Mork (connector included)
+
1 art. 0506
Rosone - Ceiling canopy

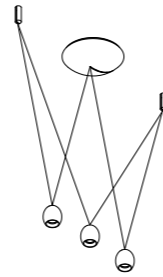
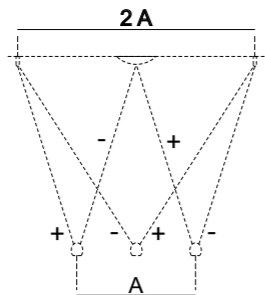

4 MORK

4 art. 1506
Mork (connector included)
+
1 art. 0506
Rosone - Ceiling canopy
+
1 art. 0507
Collegamento per configurazioni lineari da 2,4,6 Mork.
Accessory for linear configuration
2, 4 or 6 Mork.

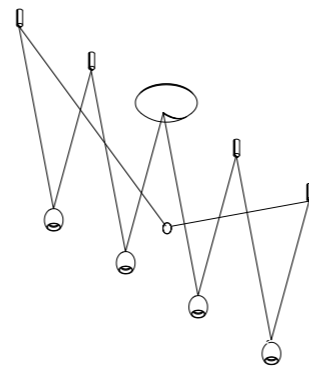
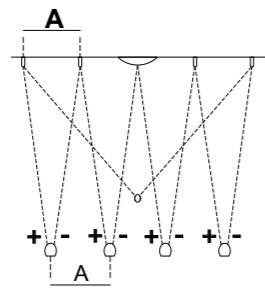

5 MORK

5 art. 1506
Mork (connector included)
+
1 art. 0506
Rosone - Ceiling canopy

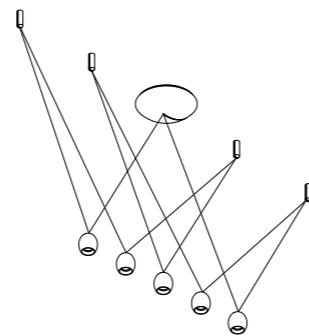
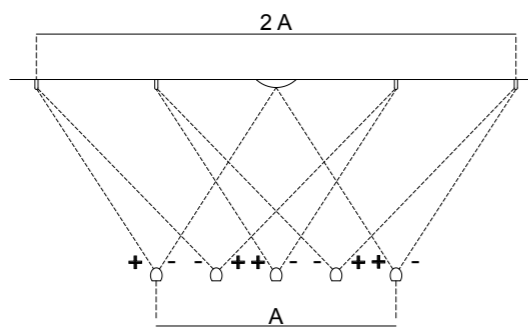

6 MORK

6 art. 1506
Mork (connector included)
+
1 art. 0506
Rosone - Ceiling canopy
+
1 art. 0507
Collegamento per configurazioni lineari da 2,4,6 Mork.
Accessory for linear configuration
2, 4 or 6 Mork.

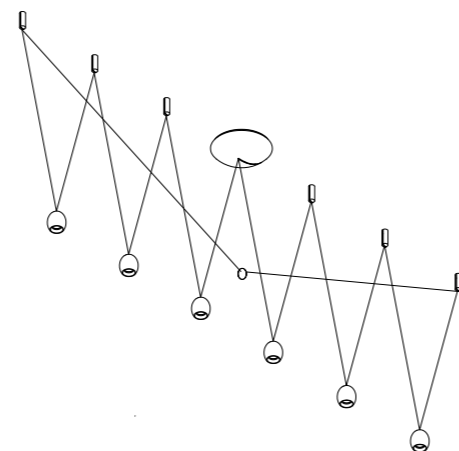
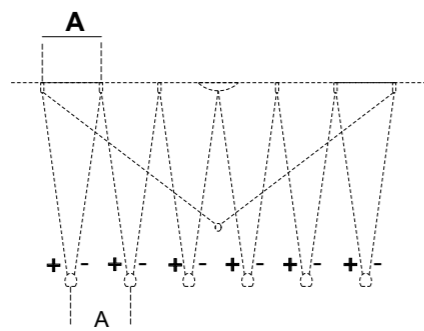

1506 0,45 kg
Led max 1400 mA (4,5W) 450 lm DC 3000K
F III 250 cm
.01

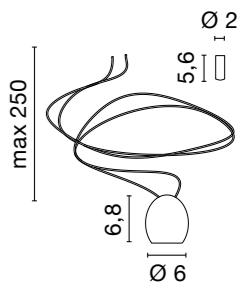

0506 0,7 kg
Rosone completo di alimentatore - max 6 Mork
Ceiling canopy with converter - max 6 Mork
230V
F
.01

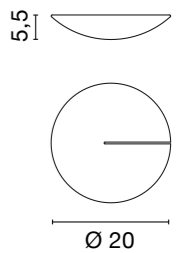

0507 0,2 kg
Collegamento per configurazioni lineari da 2, 4, 6 Mork. (Vedi pg. 37)
Optional for linear configurations 2, 4 or 6 Mork. (See pg. 37)
.01

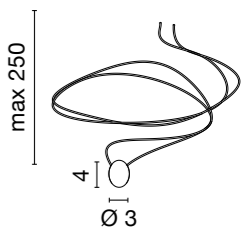

SOLO COLLEGAMENTO IN SERIE - ONLY SERIAL CONNECTION

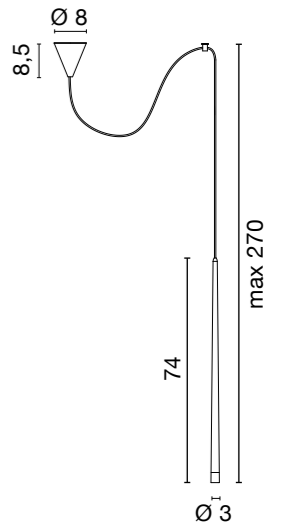

1504 0,9 Kg

Led 2W 220lm 3000k

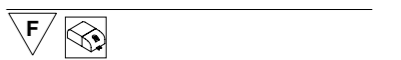

.01 .31

Sospensione in alluminio cromato o verniciato bianco. Elemento di decentramento incluso.

Suspension en aluminium chromé ou blanc laqué. Élément pour déplacement inclus.

Colgante en aluminio cromado o pintado blanco. Elemento para desplazar incluido.

Suspended lamp in aluminum chromed or painted white. Displacement component included.

Pendelleuchte aus Aluminium verchromt oder weiß lackiert. Inklusiv Versetzungselement.

Подвесной светильник в хромированном или окрашенном в белый цвет алюминии. С устройством для децентрализации.

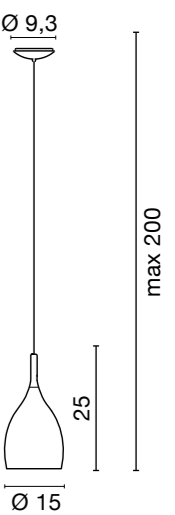
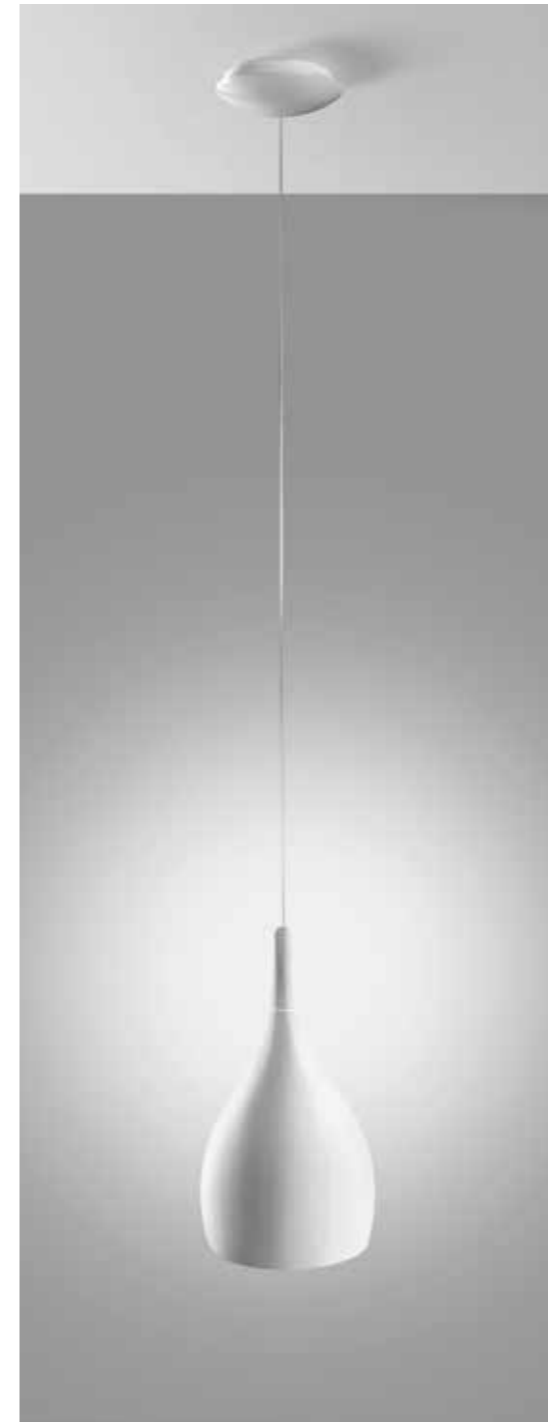

1550 1,8 Kg
Led 10W 1200lm 3000k



.01

Sospensione in metallo verniciato.
Piastre LED a tensione di rete 220-240V.

Suspension in white painted metal.
LED plates for main supply 220-240V.

Suspension en métal verni blanc.
Platine LED à tension du réseau 220-240V.

Pendelleuchte Gestell aus Weiß lackiertem Metall.
LED-module zum Betrieb an Netzspannung 220-240V.

Colgante de metal pintado blanco.
Platina de LED para tension de red 220-240V.

Подвесные светильники в алюминии,
Светодиодные платы для подключения
напрямую к сети 220в.

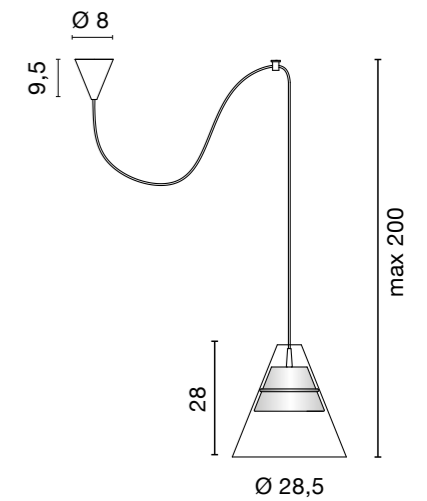

Sospensione in vetro soffiato trasparente con anello decorativo bianco. Elemento di decentramento incluso. Modulo LED CREE tecnologia True White®.

Suspension en verre soufflé transparent, anneaux décoratif blanc (inclus). Élément pour déplacement inclus. Technologie LED avec module CREE technologie True White®.

Colgante de vidrio soplado transparente, anillos decorativos intercambiables blanco y rojo (incluidos). Elemento para desplazar incluido. Modulo LED CREE tecnología True White®.

Suspended lamp in transparent blown glass, decorative white ring (included). Off-center ceiling hook included. LED module CREE True White® Technology.

Pendelleuchte aus transparentem geblasenem Glas, wechselbare dekorativen Ringe weiß inbegriffen. Versetzungselement inkl. LED Technologie, Modul CREE True White®.

Подвесной светильник из прозрачного дутого стекла с декоративным кольцом белого цвета. Устройство для децентрализации. Новая светодиодная технология с модулем CREE True White®.

1505 2,3 kg

15W 1000lm CRI > 90 3000K

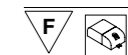



Collezione di lampade in filo di metacrilato extra-chiaro colato con tecnologia Flight-Flow.

Collection of lamps made of clear poured methacrylate yarn with Flight-Flow technology.

Collection de lampes en fil de méthacrylate extra clair coulé selon la technologie Flight-Flow.

Kollektion Von Leuchten aus Draht aus extraklar Methacrylat verschmolzen mit Flight-Flow Technologie.

Colección de lámparas echas in hilo de metacrilato colado con tecnología Flight-Flow.

Коллекция светильников, изготовленных вручную из прозрачной метакрилатовой нити по технологии Flight-Flow.

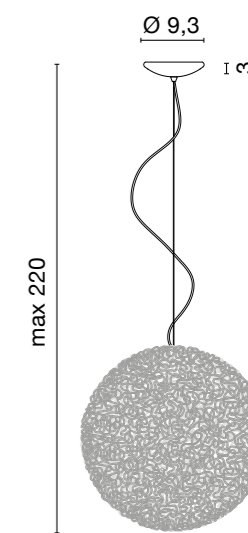

- Art. 1517 Ø 23
- Art. 1518 Ø 34
- Art. 1519 Ø 46

1517	2,2 kg
33W G9 ECO	
7W G9 Fluo EL	
4W G9 Led	
F	
.00	
1518	4,3 kg
42W E27 ECO	
16W E27 Fluo EL	
10W E27 Led (cod. 0105)	
F	
.00	
1519	7,7 kg
53W E27 ECO	
16W E27 Fluo EL	
10W E27 Led (cod. 0105)	
F	
.00	



.01 Bianco
.01 White



.01 /A Optical 3D
.01 /A Optical 3D



.01 /B Rete bianca
.01 /B White net



.01 /E Rafia argento
.01 /E Silver raffia

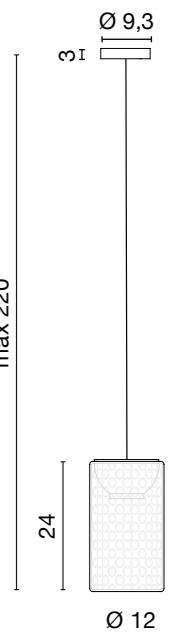

1516 1 kg
16W E27 Fluo EL
10W E27 Led (cod. 0105)
F
.01 .01/A .01/B .01/E

Lampade a sospensione e a soffitto in vetro Pyrex trasparente con inserto bianco incluso e una scelta di finiture. Sospensione con elemento di decentramento incluso.

Suspension and ceiling lamps in clear Pyrex glass with white insert included and a range of finishes. Suspension is including displacement component.

Suspensions et plafonniers en verre Pyrex transparent avec insert blanc inclus et un choix de finitions. La suspension est livrée avec élément de déplacement.

Pendent- und Deckenleuchten in transparentem Pyrexie Glas mit einem Weißem Einsatz inbegriffen und noch eine Palette verfügbar. Pendelleuchte mit Umlenkelement inbegriffen.

Colgantes y lamparas de techo de vidrio pyrex transparentes con inserto blanco incluido y gama de acabados. Lampara colgante con elemento para desplazar incluido.

Потолочные светильники из прочного боросиликатного стекла пирекс с белой вставкой. Поставляются с набором съемных декоративных аксессуаров, включая устройство для децентрализации.

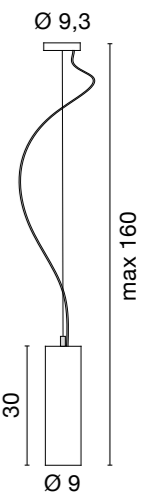

1510	1,8 kg
50W GU10	
9W GU10 Fluo EL	
8W GU10 Led (cod. 0104)	
5,5W GU10 Led (cod. 0094)	

F
 .01

Sospensione in alluminio verniciato bianco con attacco GU10.
 Elemento di decentramento incluso.

Suspension en métal verni blanc avec douille GU10.
 Élément pour déplacement inclus.

Colgante en aluminio pintado blanco con conector GU10.
 Elemento para desplazar incluido.

Suspension in white lacquered aluminum, GU10 socket.
 Displacement component included.

Pendelleuchte aus Weiß lackiertem Aluminium mit Lampenfassung GU10.
 Versetzungselement inbegriffen.

Подвесные светильники в алюминии, окрашенном в белый цвет. Цоколь GU10.
 Устройство для децентрализации.



Sospensioni con corpo in alluminio o vetro.
 Alluminio: anodizzato o verniciato bianco.
 Vetro: bianco satinato, nero o metallizzato a specchio.
 Elemento di decentramento incluso.

Suspensions with body in aluminium or glass.
 Aluminium: anodized or white painted.
 Glass: white satin, black or mirror metallized.
 Displacement component included.

Suspensions avec corps aluminium ou verre.
 Aluminium: anodisé ou blanc.
 Verre: blanc satiné, noir ou métallisé effet miroir.
 Élément de déplacement inclus.

Pendelleuchten mit Körper aus Aluminium eloxiert oder weiß lackiert;
 Glass-Diffusor matt, schwarz oder verspiegelt. Pendelversionen mit
 Umlenkelement.

Colgantes de aluminio o vidrio.
 Aluminio: anodizado o pintado blanco.
 Vidrio: blanco satinado, negro, o metalizado como uno espejo.
 Elemento para desplazar incluido.

Подвесной светильник из анодированного или окрашенного
 алюминия. Белое сатинированное, черное или зеркальное
 металлизированное стекло. Подвесной светильник с элементом
 децентрализации

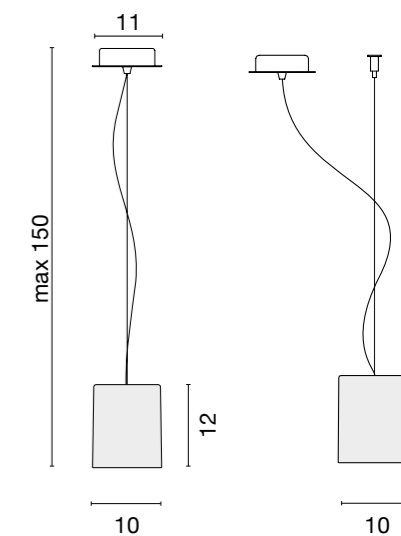

1147	1,1 kg
48W G9 ECO	
40W G9 Decopin	
4W G9 Led	
F	
.55 .57 .59	



Art. 0205 .01 .45
Cornice in acciaio con
vetro pirex sabbato - IP40
utilizzabile con lampadina
h. massima 55mm.

Steel frame with
sandblasted
pirex glass-IP40
Suitable only using lamp
h. max 55mm

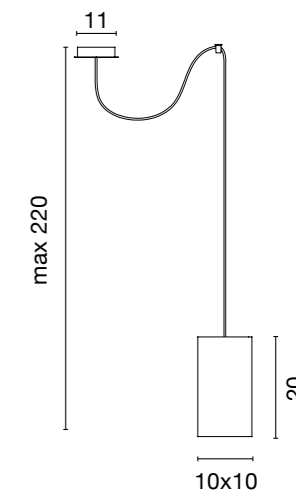

1162	0,9 kg
50W E27 PAR 20	
16W E27 Fluo EL	
10W E27 Led (cod. 0105)	
F	
.01 .45	

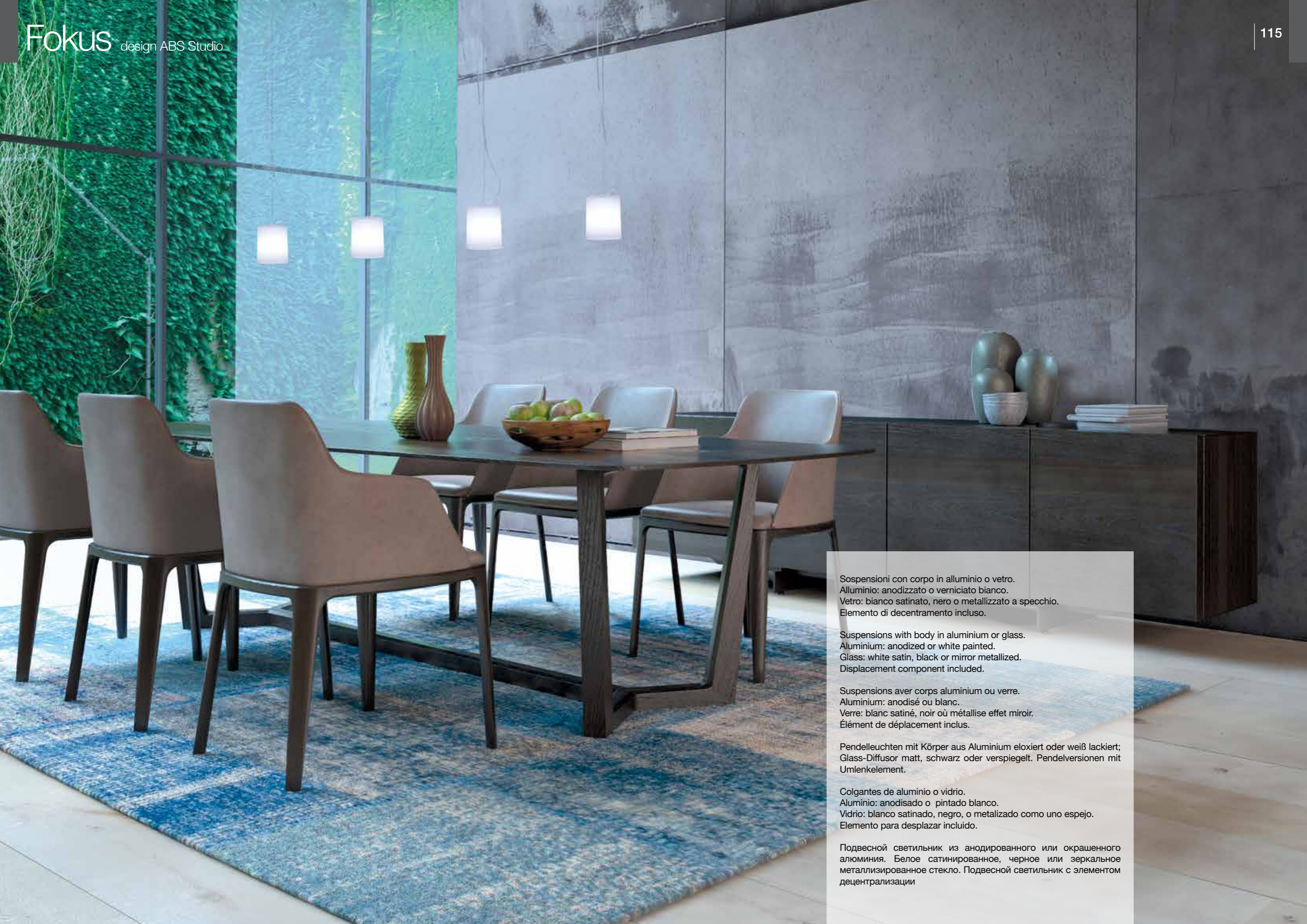

Sospensioni con corpo in alluminio o vetro.
Alluminio: anodizzato o verniciato bianco.
Vetro: bianco satinato, nero o metallizzato a specchio.
Elemento di decentramento incluso.

Suspensions with body in aluminium or glass.
Aluminium: anodized or white painted.
Glass: white satin, black or mirror metallized.
Displacement component included.

Suspensions avec corps aluminium ou verre.
Aluminium: anodisé ou blanc.
Verre: blanc satiné, noir ou métallisé effet miroir.
Élément de déplacement inclus.

Pendelleuchten mit Körper aus Aluminium eloxiert oder weiß lackiert;
Glass-Diffusor matt, schwarz oder verspiegelt. Pendelversionen mit
Umlenkelement.

Colgantes de aluminio o vidrio.
Aluminio: anodizado o pintado blanco.
Vidrio: blanco satinado, negro, o metalizado como uno espejo.
Elemento para desplazar incluido.

Подвесной светильник из анодированного или окрашенного алюминия. Белое сатиновое, черное или зеркальное металлизированное стекло. Подвесной светильник с элементом децентрализации

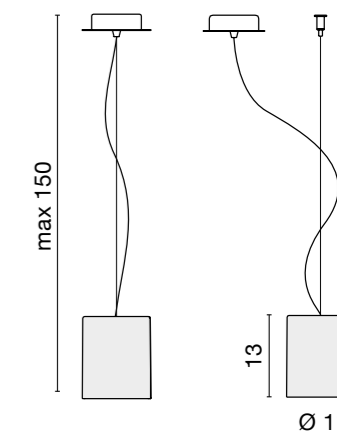

1148 1 kg
48W G9 ECO
40W G9 Decopin
F
.55 .57 .59



Art. 0204 .01 - .45
Cornice in acciaio con
vetro pirex sabbato - IP40
utilizzabile con lampadina
h. massima 55mm.

Steel frame with
sandblasted
pirex glass-IP40
Suitable only using lamp
h. max 55mm

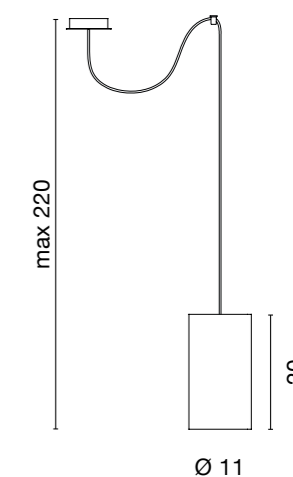

1163 0,8 kg
50W E27 PAR 20
16W E27 Fluo EL
10W E27 Led (cod. 0105)
F
.01 .45



Lampade a sospensione o a soffitto, corpo in alluminio verniciato bianco, tappi in policarbonato cromato e schermo in metacrilato satinato. Ottiche speciali disponibili come accessorio (Phantom Maxi).

Suspension and ceiling lamps. White painted aluminum body, sides in chromed polycarbonate and shade in satin methacrylate. Special diffusers are available as optional (Phantom Maxi).

Suspensions et plafonniers. Corps en aluminium, terminales en polycarbonate chromé et diffuseur en méthacrylate satiné. Diffuseurs spéciales disponibles comme accessoire (Phantom Maxi).

Pendel- sowie Deckenleuchten. Körper aus Aluminium, Seitenteile aus verchromtem Polykarbonat und Diffusor aus satiniertem Methacrylat. Sondern Diffusoren als Zubehör bestellbar (Phantom Maxi).

Lamparas de techo o colgantes, cuerpo de aluminio pintado blanco, terminales en policarbonato cromado y pantalla in metacrilato satinado. Difusores especiales disponibles como accesorios (Phantom Maxi).

Подвесной или потолочный светильник. Корпус из окрашенного алюминия, боковые детали из хромированного поликарбоната и абажур из сатинированного метакрилата. Имеются специальные диффузоры как опция (Phantom Maxi).

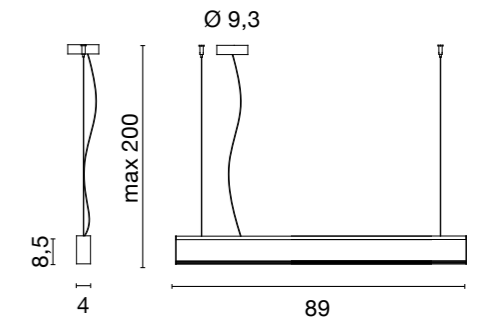

1167 2 kg

39W G5 T5

F IP 40

.01

1524 led 1,5 kg

/W Led 18,7W 2380lm 4000K

/WW Led 18,7W 2250lm 3000K

F IP 40

.01/W .01/WW

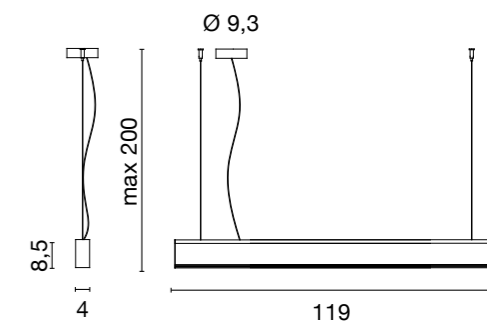

1168 2,8 kg

54W G5 T5

F IP 40

.01

1525 led 1,8 kg

/W Led 25W 3170lm 4000K

/WW Led 25W 3000lm 3000K

F IP 40

.01/W .01/WW



Optional:
Schermo ad alta efficienza
High efficiency diffuser
 Art. 0870/90
 Art. 0870/120

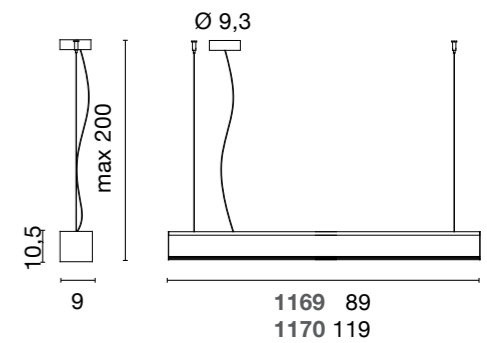

1169	3,3 kg
2x39W G5 T5	
IP 40	
.01	
1170	4,2 kg
2x54W G5 T5	
IP 40	
.01	

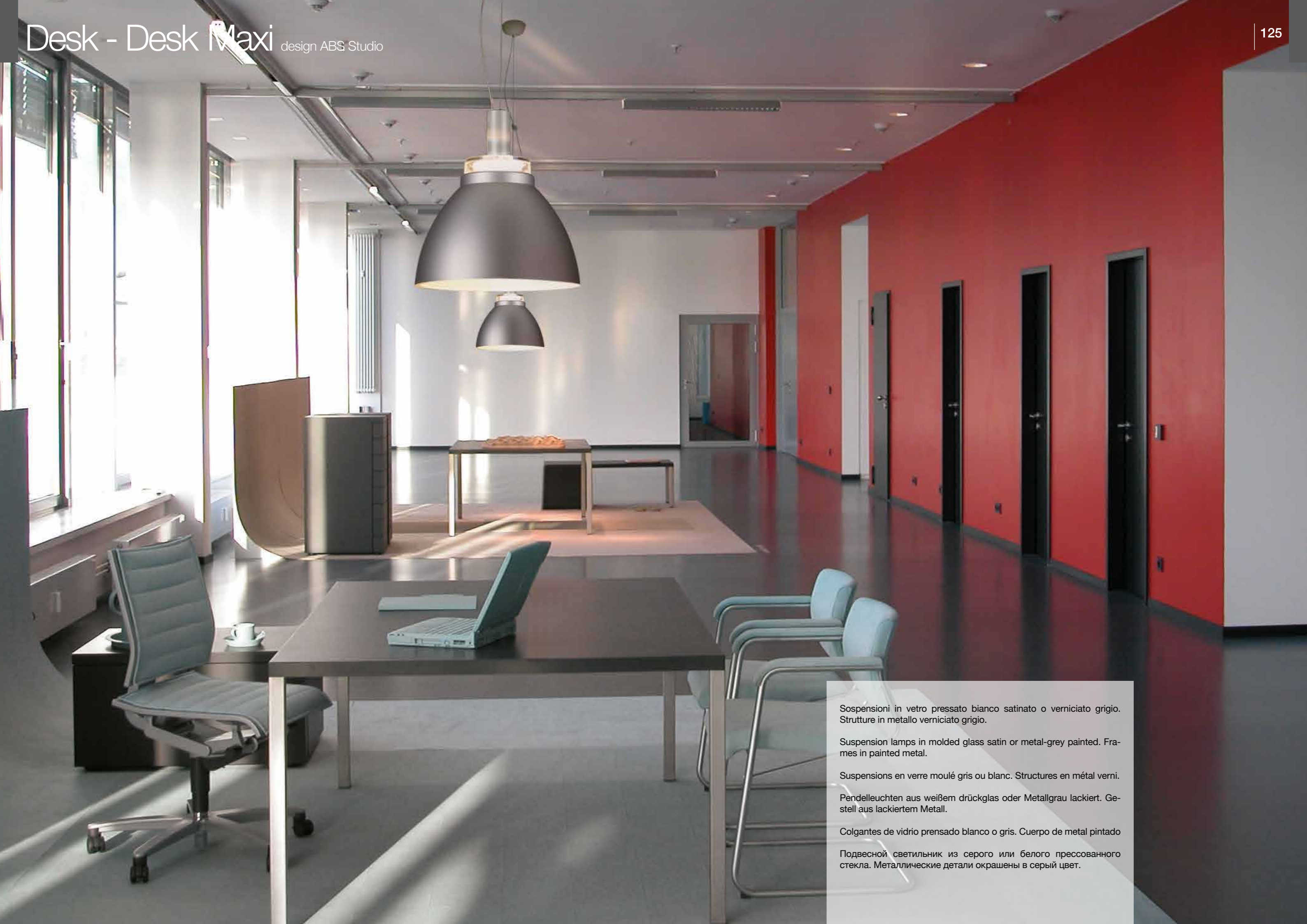

Sospensioni in vetro pressato bianco satinato o verniciato grigio. Strutture in metallo verniciato grigio.

Suspension lamps in molded glass satin or metal-grey painted. Frames in painted metal.

Suspensions en verre moulé gris ou blanc. Structures en métal verni.

Pendelleuchten aus weißem drückglas oder Metallgrau lackiert. Gestell aus lackiertem Metall.

Colgantes de vidrio prensado blanco o gris. Cuerpo de metal pintado

Подвесной светильник из серого или белого прессованного стекла. Металлические детали окрашены в серый цвет.



0531.03

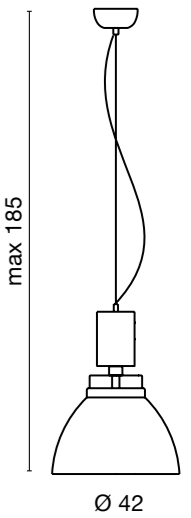

1151	7,3 kg
205W E27 ECO	
30W E27 Fluo EL	
10W E27 Led (cod. 0105)	
F	
.03 .57	

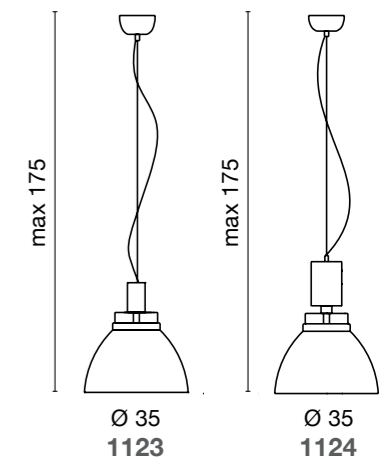

1123	4,6 kg
100W E27 Halolux ECO	
24W E27 Fluo EL	
10W E27 Led (cod. 0105)	
F	
.03 .57	

1124 fluo	5,7 kg
26W GX24 q.3	
32W GX24 q.3	
42W GX24 q.4	
F	
.03 .57	



.09

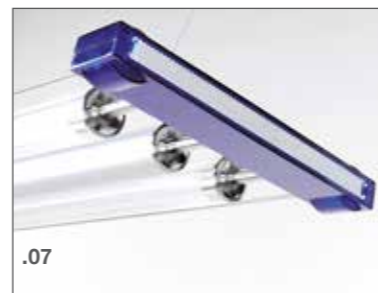

.07



.00

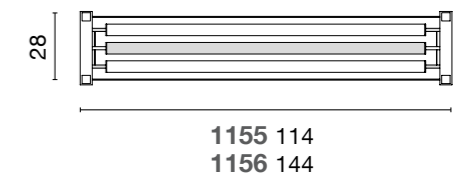
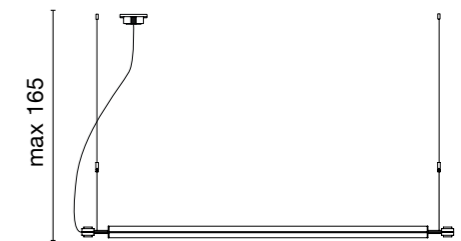

1155	2 kg
2x39W G5 T5	
.00 .07 .09	

1156	2,5 kg
2x54W G5 T5	
.00 .07 .09	

Sospensioni a luce diffusa.
Corpi in policarbonato trasparente o colorato.
Struttura e particolari in metallo cromato.

Suspensions pour lumière diffusé.
Corps en polycarbonate transparent ou coloré.
Structure et détails en métal chromé.

Colgantes para luz difusa.
Cuerpo de policarbonato transparente o colorado.
Estructura de aluminio cromado.

Suspensions for diffused.
Body in transparent or colored polycarbonate,
structure and details in chromed metal.

Hängeleuchte für diffuses Licht Beleuchtung.
Körper aus transparentem oder farbigem
Polykarbonat. Struktur und Details aus ver-
chromtem Metall.

Подвесной светильник прямого света, хорошо
отражающего свет. Корпус из прозрачного
или цветного поликарбоната, структура и
детали в хромированном металле.

Sospensioni in vetro soffiato satinato bianco.
Strutture in nickel satinato. Optional: Art. 0531.32: elemento per decentramento.

Suspensions lamps in white blown glass. Frames in nickel matt. Optional: Art. 0531.32: displacement component.

Suspensions en verre soufflé satiné opale.
Structures en nickel satiné. Accessoire: Art. 0531.32: élément pour déplacement.

Pendelleuchten mit Diffusor aus geblasenem Mattglas. Gestell in nickelmatt. Zubehör: Art. 0531.32: Befestigung für versetzten Stromauslass.

Colgantes de cristal soplado satinado blanco. Cuerpos en metal niquelado satinado.
Acesorio: Art. 0531.32: elemento para desplazar.

Подвесной светильник из белого дутого стекла.
Металлические детали из матового никеля. Как опция: элемент для децентрализации арт. 0531.32



0531.32

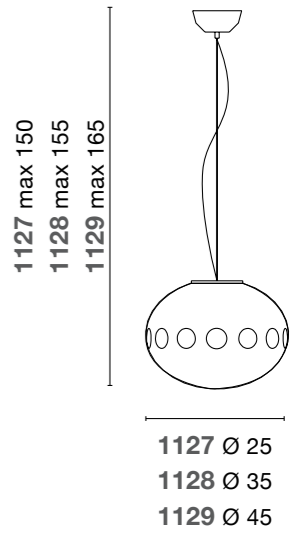

1127	2,8 kg
70W E27 ECO	
10W E27 Led (cod. 0105)	
F	
.57	
1128	3,5 kg
100W E27 Halolux ECO	
21W E27 Fluo EL	
10W E27 Led (cod. 0105)	
F	
.57	
1129	5,4 kg
100W E27 Halolux ECO	
24W E27 Fluo EL	
10W E27 Led (cod. 0105)	
F	
.57	



Collezione di lampade a paralume. con struttura in metallo verniciato bianco o nero.
Le sospensioni e le plafoniere sono dotate di schermo diffusore in metacrilato satinato.
Paralumi in tessuto ignifugo a pieghe bianco o nero.

Collection de lampes avec abat-jour avec structure en métal verni.
Les suspensions et les plafonniers sont livrées avec diffuseur en méthacrylate satiné.
Abat-jour en tissu ignifuge plissé blanc ou noir.

Lamparas con pantalla, estructura de metal pintado blanco o negro.
La version colgante y de techo tiene un difusor de metacrilato satinado.
Pantalla de tejido ignifugo blanco o negro.

Series of shaded lamps with painted metal structures white or black finish..
Suspensions and ceiling lamps are provided with satin methacrylate diffuser.
Lampshades in plissé fireproof cloth white or black.

Kollektion von Schirmleuchten mit Gestell aus weiß oder schwarz lackiertem Metall.
Hänge- und Deckenleuchten sind mit einem Diffusor aus satiniertem Metacrylat ausgestattet.
Schirm aus feuerfestem Stoff plissé schwarz oder weiß.

Серия ламп с абажурами. Металлическая структура окрашена в белый или черный цвет.
Подвесные светильники с рассеивателем из матового метакрилата и устройством децентрализации. Абажуры из негорючей плиссированной ткани черного и белого цвета.

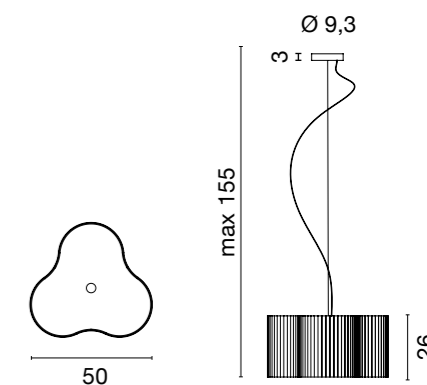

1164	1.6 kg
70W E27 ECO	
24W E27 Fluo EL	
10W E27 Led (cod. 0105)	
F	
.01 .02	

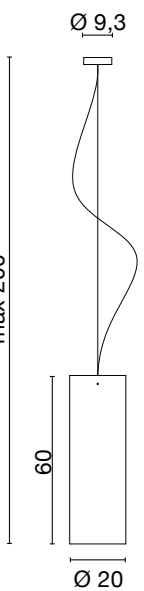

Lampada da sospensione in metacrilato bianco con superficie effetto seta é cru.

Suspension en méthacrylate blanc avec surface effet soie.

Lámparas colgante en metacrilato blanco con superficie efecto seda cruda.

S uspensionlamp in white methacrylate with silky smooth surface.

Pendelleuchte aus weißem Metacrylat mit Seide-Effekt Oberfläche.

Подвесной и напольный светильник из белого метакрилата с шелковистой гладкой поверхностью.

1166

24W E27 Fluo EL

10W E27 Led (cod. 0105)

1,8 kg



.01



0531.01

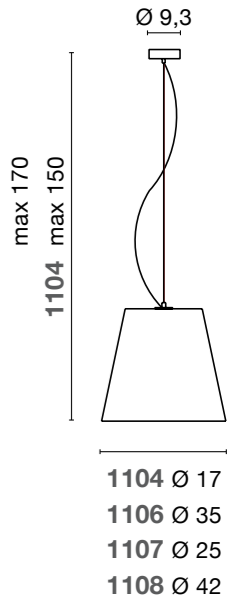

1104	0,7 kg
48W G9 ECO	
F	
.57	

1106	2,5 kg
100W E27 Halolux ECO	
24W E27 Fluo EL	
10W E27 Led (cod. 0105)	
F	
.57	

1107	1,2 kg
52W E27 ECO	
16W E27 Fluo EL	
10W E27 Led (cod. 0105)	
F	
.57	

1108	4,2 kg
100W E27 Halolux ECO	
24W E27 Fluo EL	
10W E27 Led (cod. 0105)	
F	
.57	

Lampade a sospensione e parete in vetro soffiato satinato bianco.
Optional: Art. 0531.01: elemento per decentramento.

Suspension and wall lamps in white blown glass.
Optional: Art. 0531.01: displacement component.

Suspensions et appliques en verre soufflé satiné opale. Accessoire: Art. 0531.01: élément pour déplacement.

Pendel- und Wandleuchten aus mundgeblasenem Mattglas opal.
Zubehör: Art. 0531.01: Befestigung für versetzten Stromauslass.

Aplicques y colgantes de cristal curvado satinado blanco. Accesorio: Art. 0531.01: elemento para desplazar.

Подвесной и настенный светильник из белого или цветного дутого стекла.
Как опция: арт. 0531.01 элемент для децентрализации.

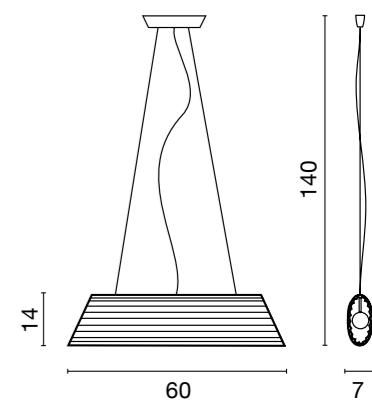

Lampade sospensione, parete con struttura in metallo.
Doppio diffusore esterno in vetro pyrex trasparente e diffusore interno satinato.

Suspension, ceiling wall and lamps with metal structure.
Double diffuser outer in transparent Pyrex glass, internal diffuser matt.

Suspensions, appliques et plafonniers avec structure en métal.
Double diffuseurs : extérieur en pyrex transparent et intérieur en satiné.

Pendelleuchten sowie Wand-/Deckenleuchten mit Struktur aus Metall.
Doppel Diffusor: Außen aus Klarem Pyrexglass und Innere satiniert.

Colgantes, lamparas de pared y de techo, cuerpo de metal. Doble difusor: exterior en vidrio pyrex transparente y interior satinado.

Подвесной, настенный или потолочный светильник с корпусом из металла. Внешний диффузор из прозрачного матового стекла пирекс, внутренний матовый.

1143

2x80W R7s (78 mm.) ECO



.50

3 kg



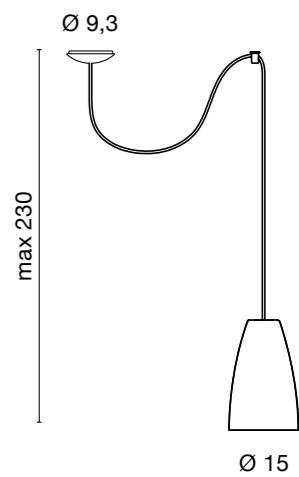

1133	1 kg
52W E27 ECO	
24W E27 Fluo EL	
10W E27 Led (cod. 0105)	



Sospensione in vetro soffiato satinato bianco. Strutture in metallo verniciato. Incluso elemento per decentramento.

Suspension en verre soufflé satiné. Structures en métal verni. Élément pour déplacement inclus.

Colgante de vidrio soplado satinado y cuerpo de metal pintado. Elemento para desplazar incluido.

Suspension lamp in blown matt glass. Frame in painted metal. Displacement component included.

Pendelleuchte aus geblasen Mattglas. Gestell aus lackiertem Metall. Inklusiv Versetzungselement.

Подвесной светильник из дутого матового стекла. Детали из окрашенного металла. Элемент для децентрализации.

Parete - Wall



Akuta 220



Alba 182



Alea 192

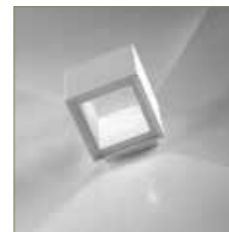

Alealed 164



Arianna 234



Mats 146

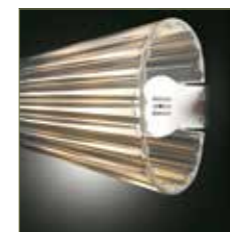

Maya 214



Minipathos 212



Monet 228

Olimpia
Miniolimpia 200

Baloon 178



Brigitte 236



Ci 152

Drim
Drimangolo 208

Ekus 232



Pupilla 156



Quinta 206



Rail 170



Rap 190



Read 226



Fokus 196



Frida 210



Fusò 202

Ikon
Ikon Maxi 222

Kalla - Kalladue 174



Slash 186

Teda
Miniteda 218

Tekna 184



Trace 188



Yoda 216



Kirk 224



Lancia 160



Linx 230



Liola 204



Matassa 180



Sistema di apparecchi da parete realizzati con sorgenti COB LED.

Corpo in metallo verniciato, disponibile in due dimensioni, finiture: bianco, nero e sabbia. Include accessorio per cablaggio passante che permette di collegare più apparecchi ad un unico punto d'alimentazione. Alimentatore integrato.

System of wall lamps fitted with COB LED light engine.

Painted metal body available in two dimensions, finishes: white, black and sand. A wiring accessory allowing to connect more units to a single cable outlet is included. Converter on board.

Système d'appliques équipées avec technologie COB LED.

Corps en métal verni disponible en deux dimensions, finitions: blanc, noir et sable. Un accessoire de câblage inclus permet de connecter plusieurs unités à un seul point d'alimentation. Convertisseur intégré.

Wandleuchten-System mit COB LED-Modulen. Körper aus lackiertem Metall, erhältlich in zwei Größen. Ausführungen: weiß, schwarz und sand. Zubehör zur Durchgangsverdrahtung mehrerer Elemente inbegriffen. Integrierter Konverter.

System of wall lamps fitted with COB LED light engine. Painted metal body available in two dimensions, finishes: white, black and sand. A wiring accessory allowing to connect more units to a single cable outlet is included. Converter on board.

Sistema de lámparas de pared equipados con fuente de luz COB LED.

Cuerpo de metal pintado disponible en dos tamaños, acabados: blanco, negro y arenoso. Está incluido un accesorio que permite conectar mas unidades a un solo punto de alimentación. Convertidor integrado.

Система настенных светильников со светодиодами на плате. Металлический корпус есть в 2 размерах и цветах: белый, черный песчаный. Аксессуар, позволяющий подключить несколько приборов к одному силовому кабелю. Конвертер включен.

System of wall lamps fitted with COB LED light engine. Painted metal body available in two dimensions, finishes: white, black and sand. A wiring accessory allowing to connect more units to a single cable outlet is included. Converter on board.

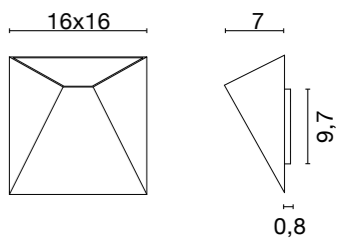

4564 0,6 kg

Led 6,5W 844lm 3000K



.01/WW .02/WW .35/WW

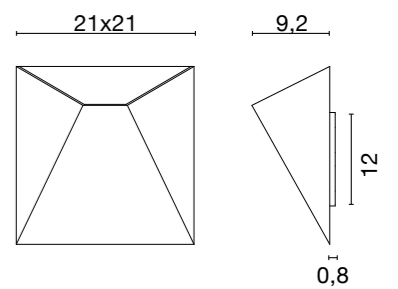

4565 1 kg

Led 9,8W 1111lm 3000K



.01/WW .02/WW .35/WW

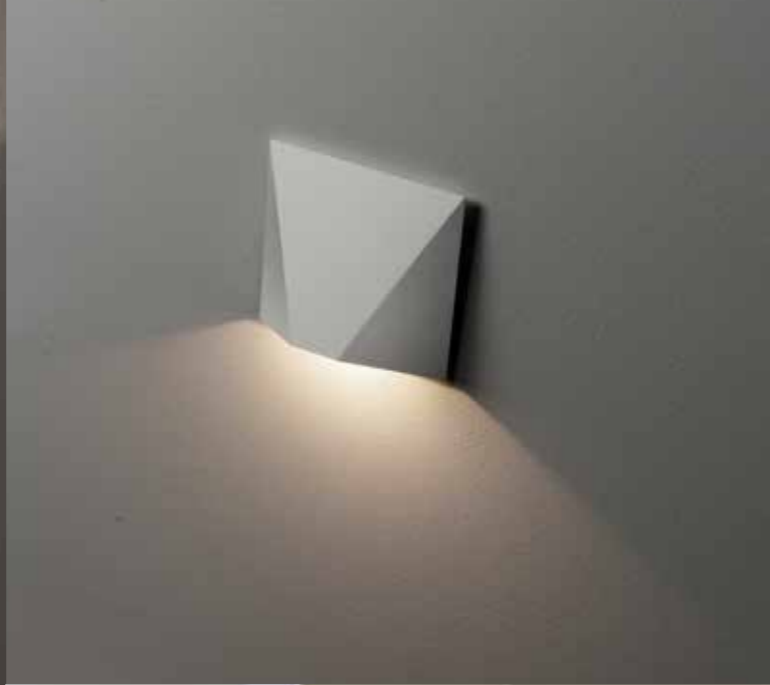

Esempio di installazione multipla da un unico punto luce
Example of multiple installation starting from a single cable outlet

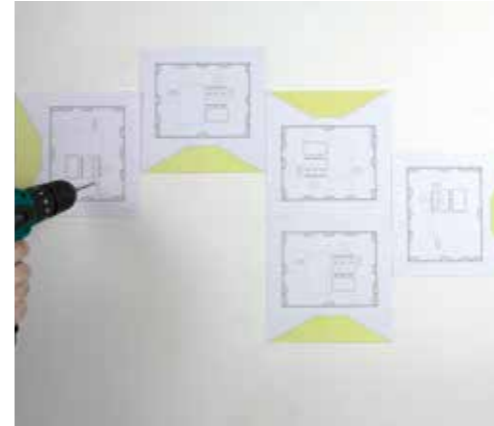

Posizionamento dime e foratura in base alla posizione desiderata
Positioning of the drilling template

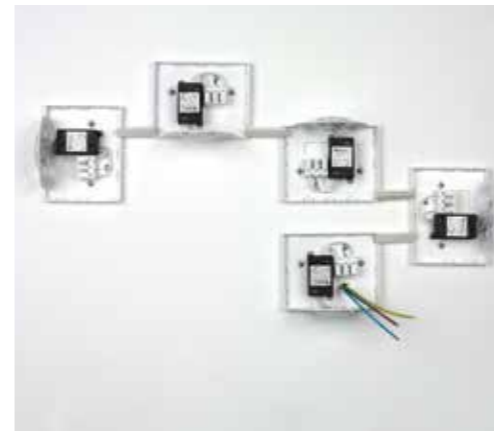

Fissaggio montature con uscita alimentazione da un solo punto luce e predisposizione collegamenti
Installation of mounting plates starting from a single cable outlet

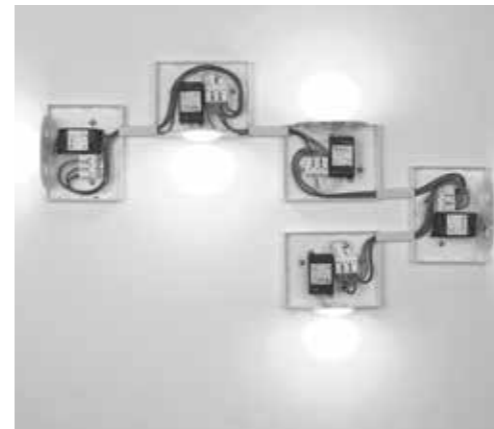

Realizzazione cablaggio passante tra le singole montature
Realization of electrical connection between single units



Montaggio maschere e accensione
Assembly of the front plates

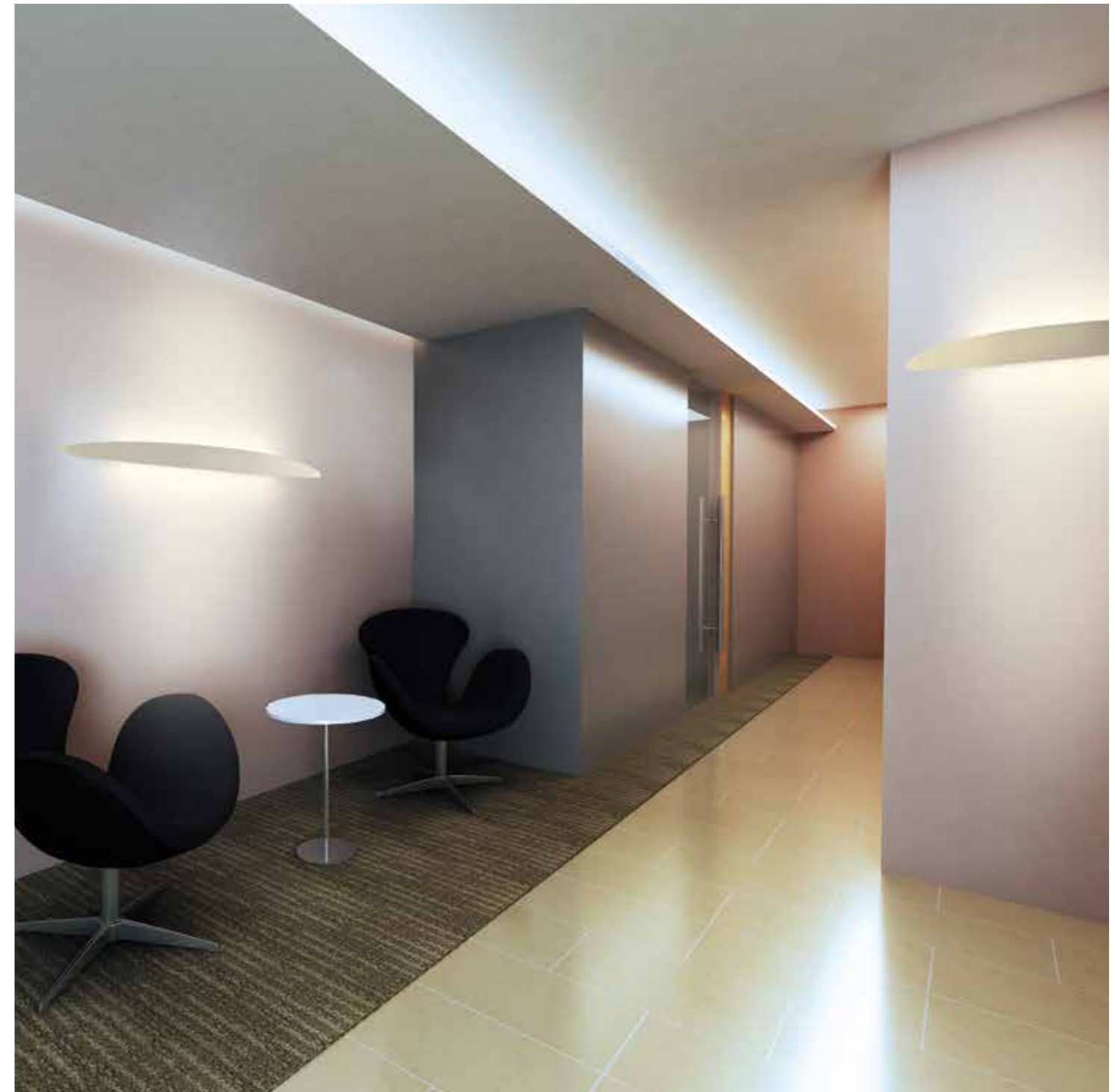

Serie di lampade a parete di grandi dimensioni per luce radente.
I corpi, realizzati in alluminio, utilizzano come sorgente potenti circuiti LED lineari di ultima generazione. Converter integrato. Disponibili in bianco o nero.

Series of large sized wall lamps for grazing light. The aluminum structures are fitted with powerful latest generation linear LED circuits. Integrated converter. Available in white or black finishes.

Série d'appliques de grands dimensions pour lumière rasante. Corps en aluminium équipé de puissants circuits linéaires LED de dernière génération. Convertisseur intégré. Disponible en blanc ou noir finitions.

Serie großer Wandleuchten für Streiflicht. Die Strukturen aus Aluminium sind mit leistungsstarken linearen LED Modulen der neuesten Generation ausgestattet. Integrierter Converter. Erhältlich in weiss oder schwarz Ausführungen.

Serie de lámparas de pared de grande tamaño por luz rasante. Las estructuras de aluminio están equipadas con potentes circuitos lineares LED de última generación. Convertidor integrado. Disponible en blanco o negro acabados.

Серия больших настенных светильников с брeющим лучом. Корпус из алюминия. Мощные светодиодные линейные светодиоды. Конвертер включен. Цвета: белый или черный.

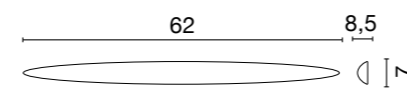
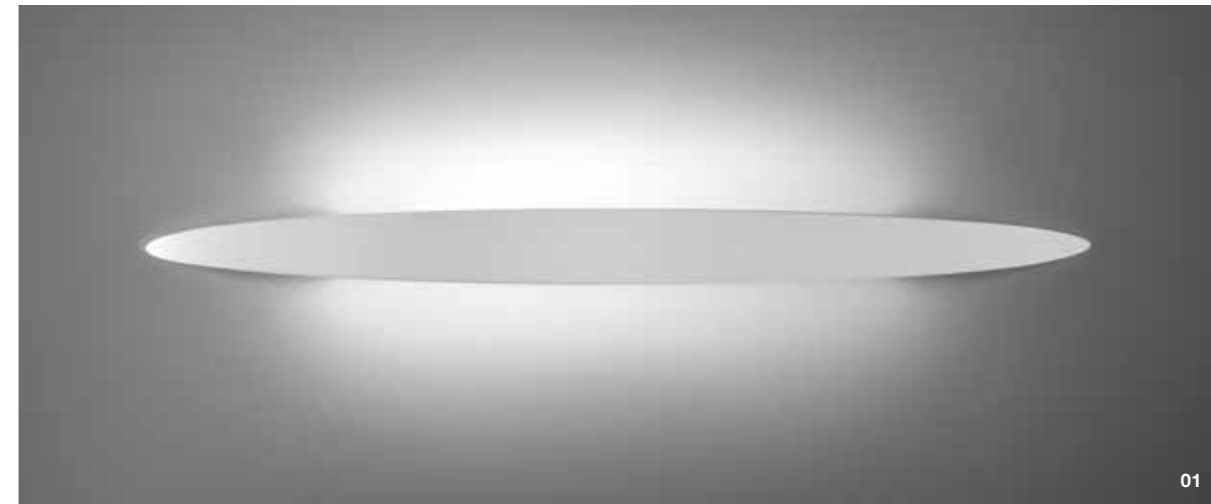

4574 1,7 kg
 /W Led 12,5W 1585lm 4000K
 /WW Led 12,5W 1502lm 3000K
 F
 .01/W .01/WW .02/W .02/WW

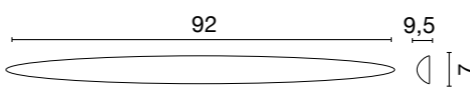

4575 2 kg
 /W Led 25W 3170lm 4000K
 /WW Led 25W 3004lm 3000K
 F
 .01/W .01/WW .02/W .02/WW

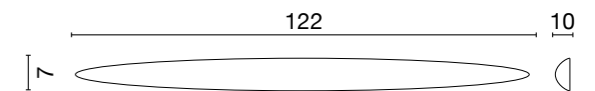

4576 3 kg
 /W Led 37,5W 4755lm 4000K
 /WW Led 37,5W 4506lm 3000K
 F
 .01/W .01/WW .02/W .02/WW

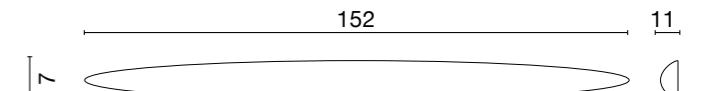

4577 3,9 kg
 /W Led 50W 6340lm 4000K
 /WW Led 50W 6008lm 3000K
 F
 .01/W .01/WW .02/W .02/WW

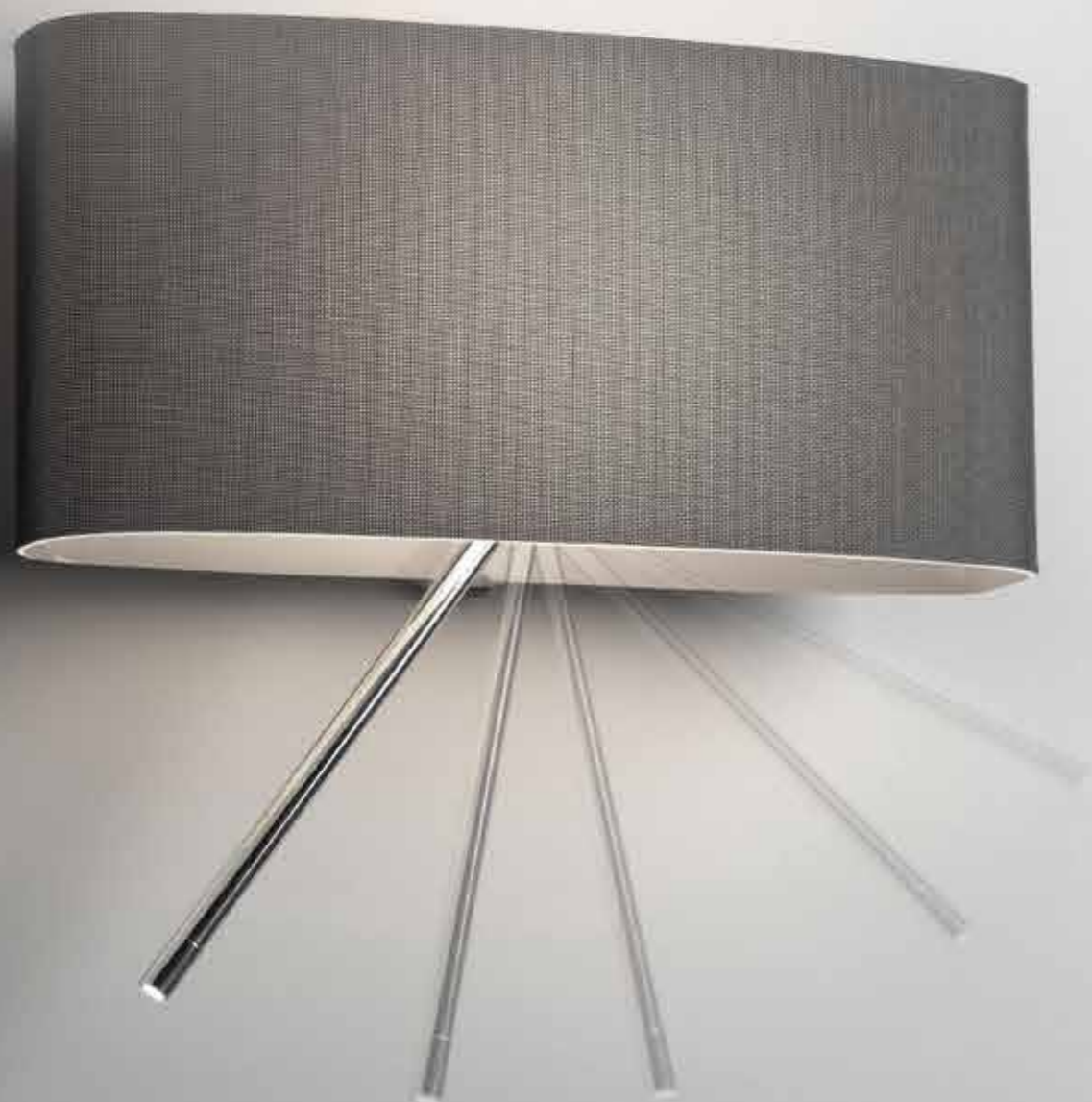

Lampada da parete con o senza luce orientabile da lettura integrata. Diffusore in metacrilato opalino rivestito in tessuto tecnico ignifugo nero o grigio perla. La luce diffusa viene fornita da una piastra LED a tensione di rete 220/240V, mentre per la luce da lettura viene utilizzando un power LED con alimentatore a bordo.

Wall lamps with or without integrated adjustable reading light. Opal methacrylate diffuser coated with composite fabric fireproof black or pearl grey. Ambient lighting is granted by a LED plate for main supply 220-240V, whereas personal reading light is supplied by a power LED with converter on board.

Applique avec ou sans lampe de lecture orientable intégrée. Diffuseur en méthacrylate opalin couvert en tissu composite ignifuge noir ou gris perl. La lumière diffusée est fournie par une plaque LED à tension du réseau 220 / 240V; pour la lumière de lecture on utilise une LED de puissance avec convertisseur a bord.

Wandleuchte mit oder ohne integrierte aufrichtbare Leseleuchte. Diffusor aus opalisiertem Acrylglas, mit Kunstfasergewebe feuerfestem schwarz oder perlgrau beschichtet. Die Wandleuchte ist mit einem LED Modul für Netzspannung 220-240V ausgestattet, die Leselampe mit einem LED-Modul und integriertem Konverter.

Lámparas de pared con o sin luz de lectura ajustable integrada. Difusor de metacrilato opalino recubierto con tejido compuesto ignifugo negro o gris perla. Por la iluminación ambiente se utiliza placa de LED para tensión de red 220-240V mientras la luz de lectura es suministrada por un LED de potencia con convertidor integrado.

Бра со встроенной лампой для чтения или без нее. Диффузор из матового метакрилата, покрытого композитной Серой или черной тканью. Светодиодная плата, подключенная в сеть 220в, дает рассеянный свет, а мощный диод с конвертером дает свет для чтения.



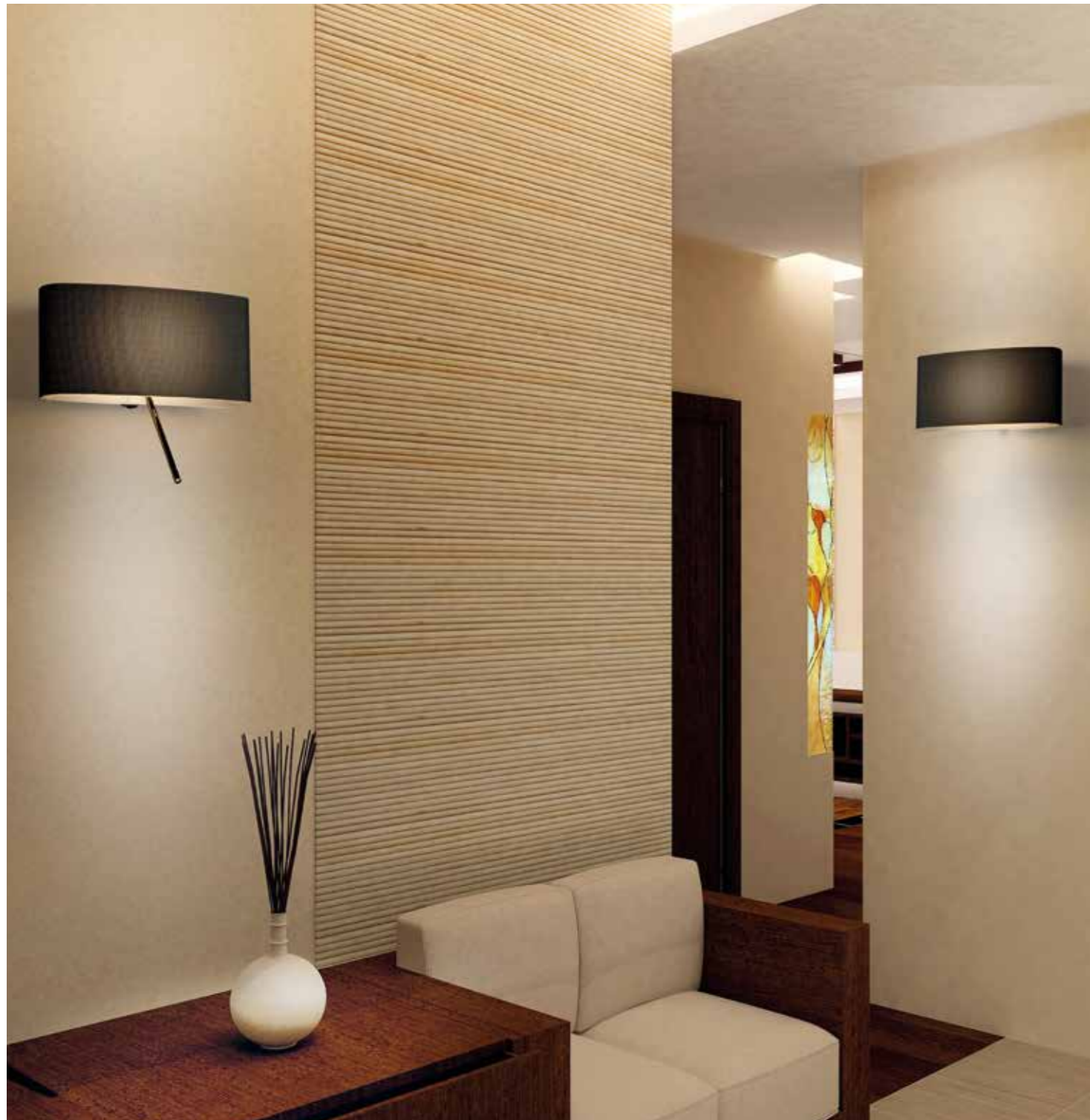

.36/WW Tessuto nero
.36/WW Black cloth



.37/WW Tessuto grigio perla
.37/WW Pearl grey cloth

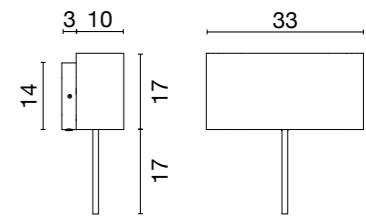

4571 1,3 kg

Led 10W 1200lm 3000K +

Led 1W 130lm 3000K



.36/WW .37/WW

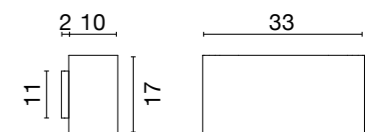

4572 0,9 kg

Led 10W 1200lm 3000K

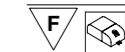

.36/WW .37/WW



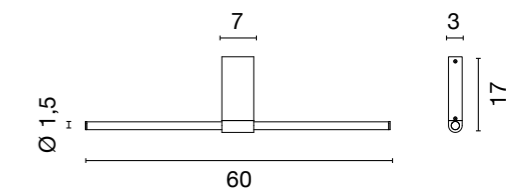
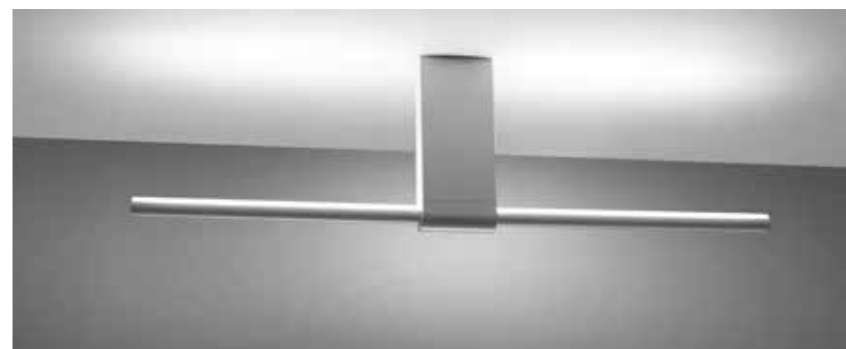

4567 0,8 kg

Led 9W 1190lm 3000K CRI >90



.01/WW .31/WW

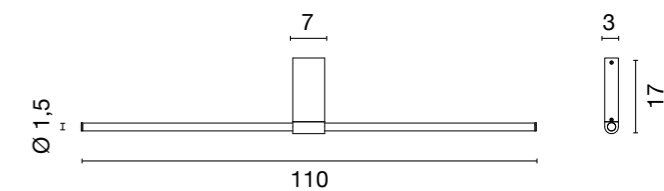

4568 1 kg

Led 18W 2380lm 3000K CRI >90

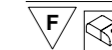

.01/WW .31/WW

Serie di lampade orientabili da parete, sospensione o terra.

I circuiti lineari LED con CRI 90, garantiscono una resa cromatica ottimale per l'illuminazione di quadri.

Struttura in alluminio verniciato bianco, diffusore in metacrilato satinato.

La versione da terra prevede anche un utilizzo a parete grazie all'apposito attacco incluso.

Le versioni a sospensione sono realizzabili, a richiesta, in misure speciali modulari.

Série de lampes réglables applique, suspension ou lampadaire. Équipé avec circuits linéaires LED délivrant un CRI 90 pour garantir une rendu couleurs optimale dans l'éclairage de tableau. Structure en aluminium laqué blanc et diffuseur en méthacrylate satiné.

La version lampadaire est doué d'une patère supplémentaire qui permet l'installation murale. Les versions suspension sont disponibles, sur requête, dans des longueurs modulaires spéciaux.

Series of adjustable wall-lamps, suspensions or standing.

Fitted with linear LED circuits granting CRI 90 in order to achieve optimal color rendering for pictures lighting. Structure in white painted aluminum and satin methacrylate diffuser.

The floor version includes an additional bracket that allows wall installation.

Suspended versions are available, upon request, in modular special lengths.

Serie von ausrichtbarer Wand-, Pendel- und Stehleuchten.

Ausgestattet mit LED-Modulen CRI >90, um die optimale Farbwiedergabe bei der Beleuchtung von Bildern zu erzielen. Struktur aus weiß lackiertem Aluminium und Diffusor aus satiniertem Acrylglas.

Die Stehleuchte bietet eine zusätzliche Halterung für eine etwaige Wandbefestigung.

Pendelversionen sind, auf Anfrage, auch in modularen Sonderlängen lieferbar.

Serie de lámparas ajustables de pared, colgantes y de pie.

Equipados con circuitos lineares LED con CRI 90 para alcanzar un índice de reproducción cromática óptimo para la iluminación de cuadros. Estructura de aluminio pintado blanco y difusor de metacrilato satinado.

La versión de pie incluye un soporte adicional que permite la instalación a pared.

Las versiones suspendidas están disponibles, previa solicitud, en medidas modulares especiales.

Серия настенных, подвесных или напольных поворотных светильников.

Линейные светодиодные модули гарантируют индекс цветопередачи CRI>90, идеальны для подсветки картин. Корпус из окрашенного алюминия, диффузор матовый метакрилат. Торшер снабжен кронштейном, позволяющим крепить также к стене. Подвесные варианты могут быть исполнены по запросу в других размерах.

Подвесные варианты могут быть исполнены по запросу в других размерах.

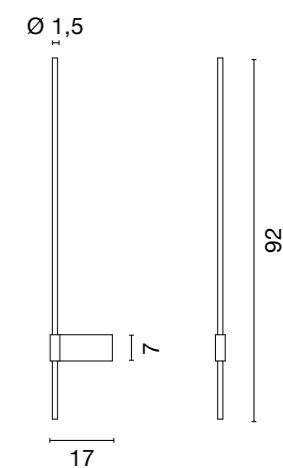

4569 0,9 kg
Led 16,5W 2182lm 3000K CRI>90
F 
.01/WW .31/WW

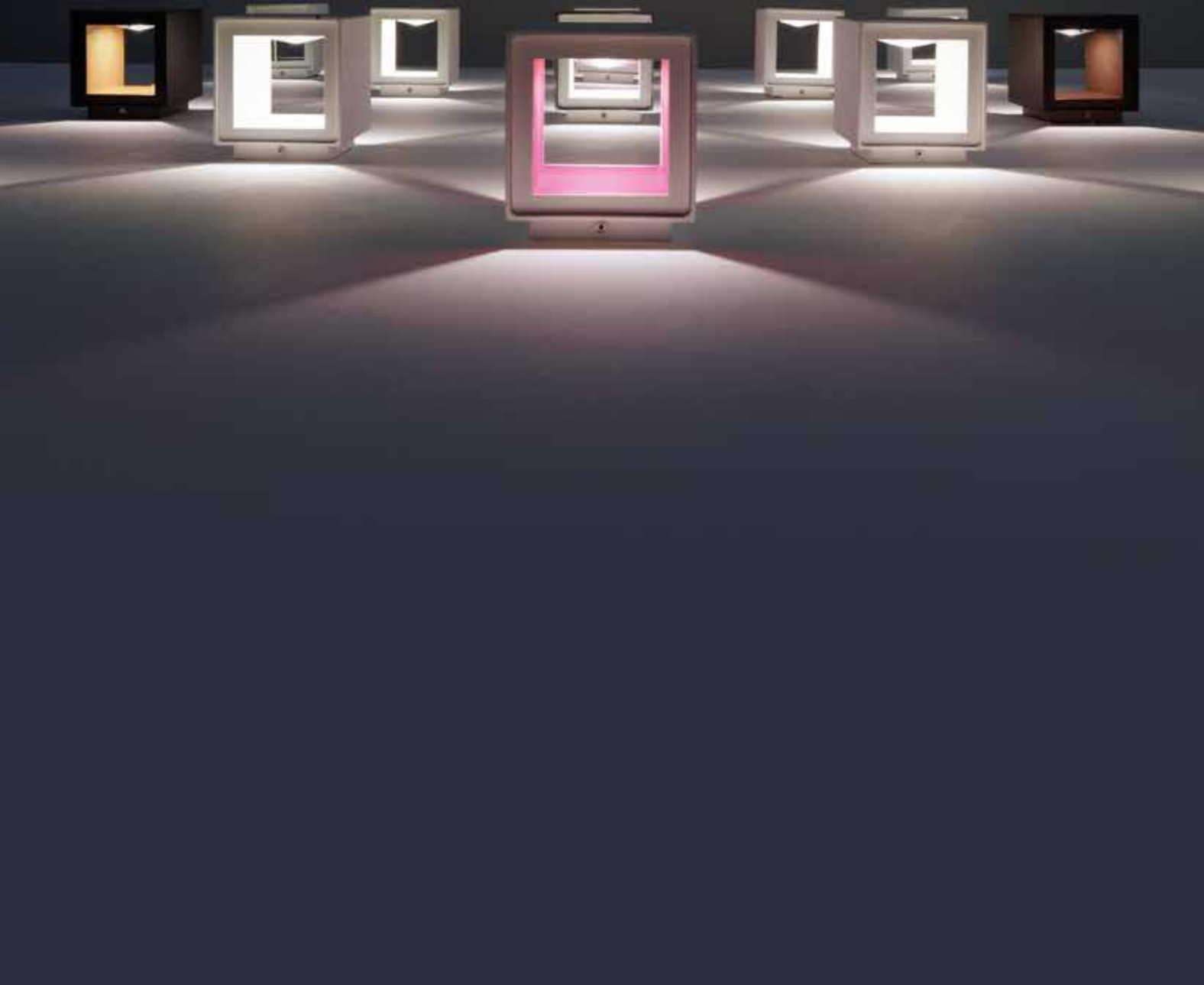

Lampada da parete in alluminio verniciato con sorgente COB LED ed alimentatore integrato. Disponibile nelle finiture: bianco, cromo, sabbia, nero/oro e bianco/fucsia.

Wall lamp in painted aluminum fitted with COB LED light engine and converter on board. Available in following finishes: white, chrome, sand, black/gold and white/fuchsia.

Applique en aluminium verni avec source de lumière COB LED et alimentation intégrée. Disponible dans les finitions: blanc, chromé, sable noir/or et blanc/fuchsia.

Wandleuchte aus lackiertem Aluminium mit COB LED-Modul. Integrierter Konverter. Erhältlich in folgenden Ausführungen: Weiß, Verchromtem, Sand schwarz/Gold und weiß/fuchsia.

Lámpara de pared en aluminio pintado equipado con fuente de luz COB LED y convertidor integrado. Disponible en los siguientes acabados: blanco, cromado, arena, negro/oro y blanco/fucsia.

Настенный светильник из окрашенного алюминия. Светодиод на плате. С конвертером. Отделки: белая, серая, песочная, черная/золотая и белая/фуксия.

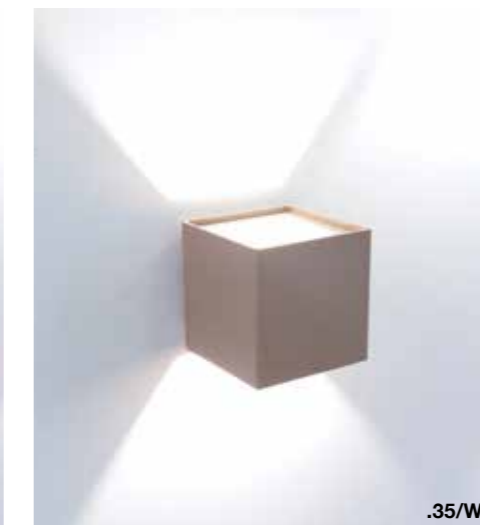
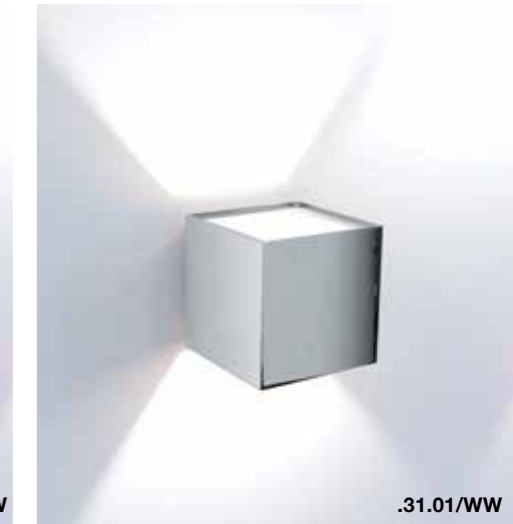

Art. 0182 .01-.02-.35
schermo per luce monodirezionale
Screen for single side light

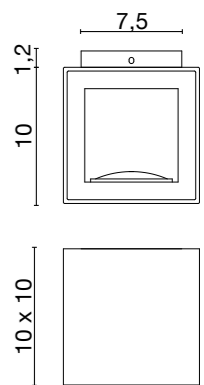

4561 led 0,7 kg

Led 6,5W 844lm 3000K



.01/WW .01.11/WW .02.29/WW .31.01/WW .35WW

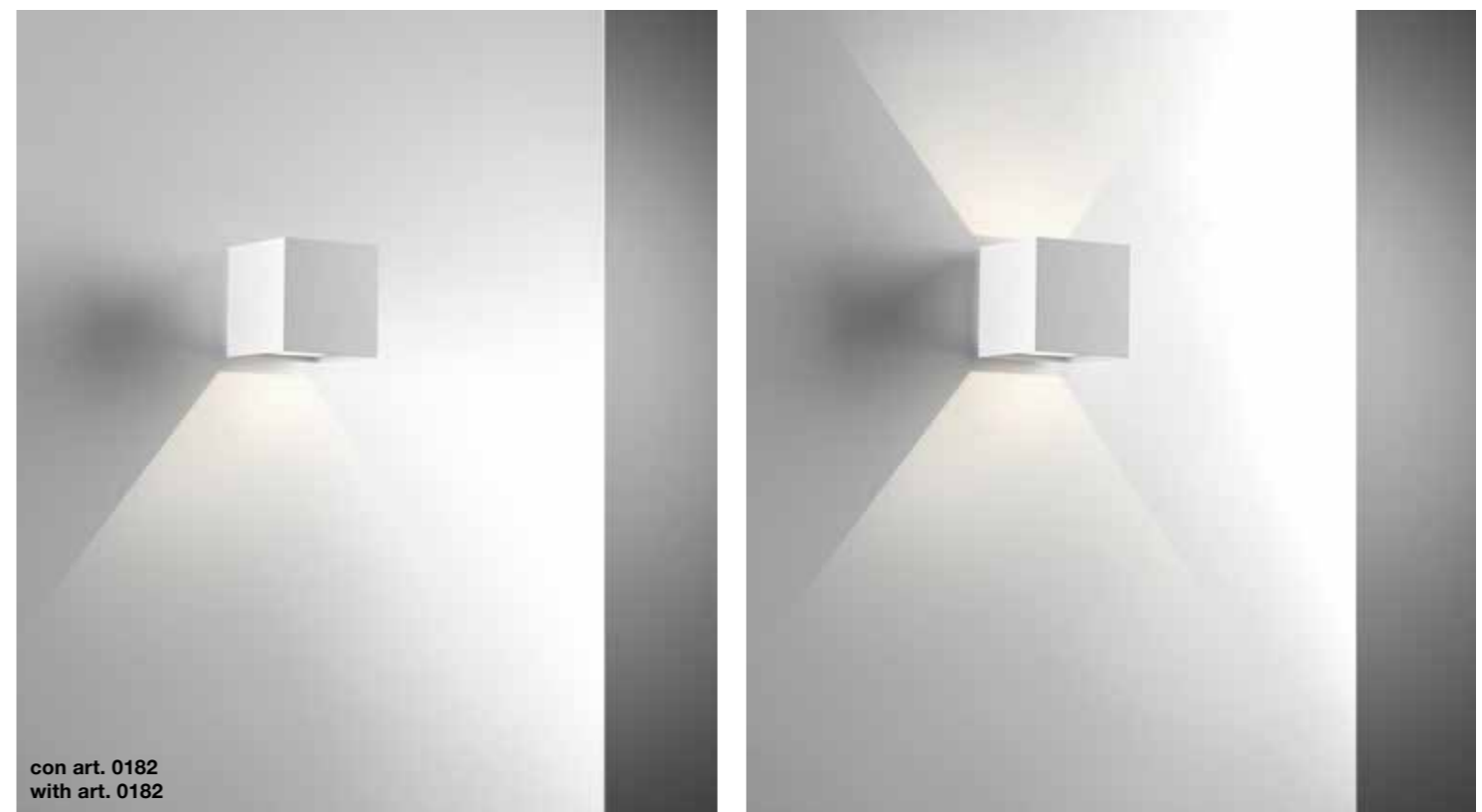
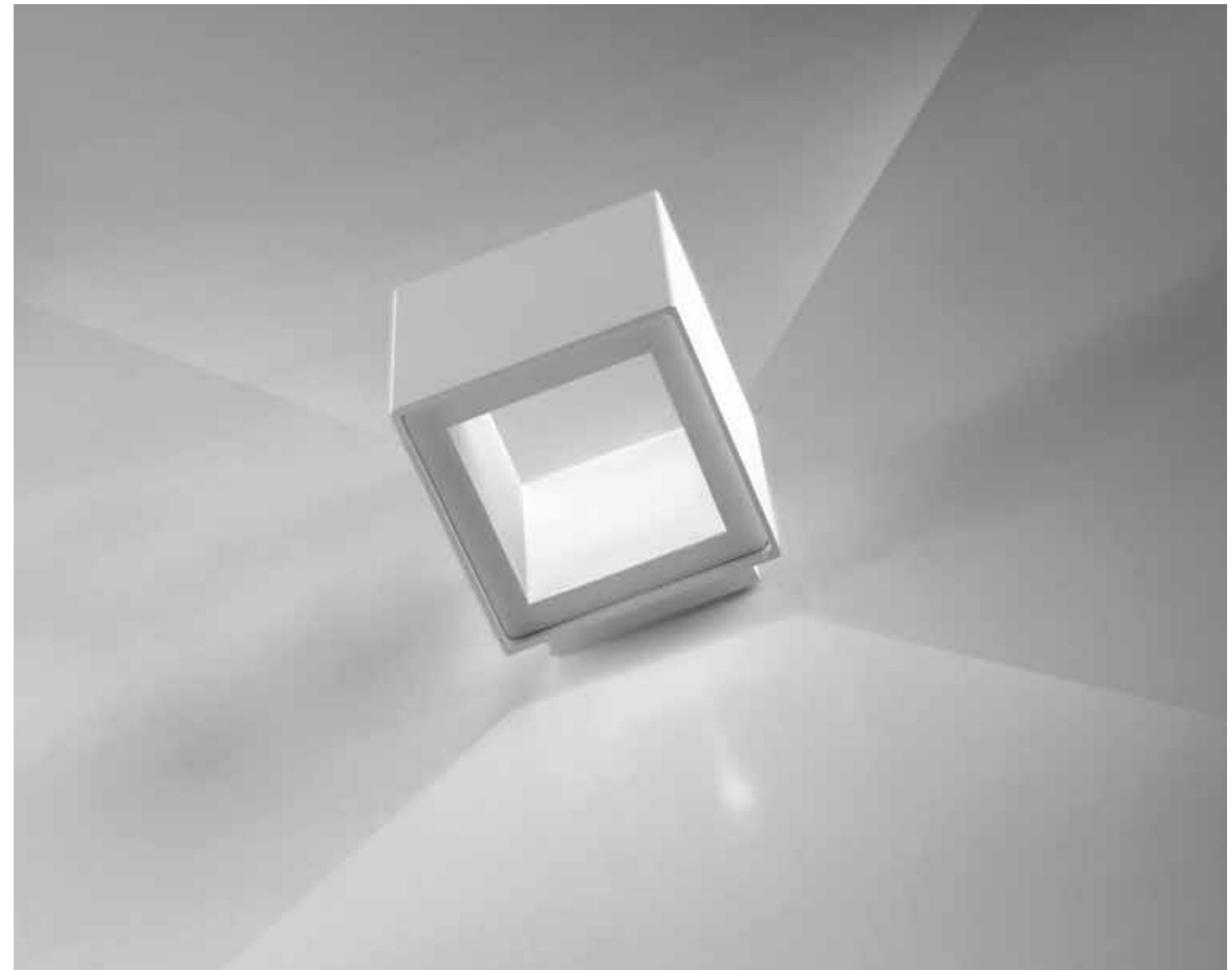

con art. 0182
with art. 0182



SU MISURA - CUSTOM SIZE

Tabella lunghezze disponibili a richiesta.
Table of available lengths on request.

cm.	watt	white 4000K (W)	lm	warm white 3000K (WW)	lm
62	9W	A4578.01/60/W	1230	A4578.01/60/WW	1188
72	10,5W	A4578.01/70/W	1436	A4578.01/70/WW	1386
82	12W	4578.01/W *	1641	4578.01/WW *	1584
92	13,5W	A4578.01/90/W	1846	A4578.01/90/WW	1782
102	15W	A4578.01/100/W	2051	A4578.01/100/WW	1980
112	16,5W	A4578.01/110/W	2256	A4578.01/110/WW	2178
122	18W	A4578.01/120/W	2461	A4578.01/120/WW	2376
132	19,5W	A4578.01/130/W	2666	A4578.01/130/WW	2574
142	21W	A4578.01/140/W	2871	A4578.01/140/WW	2772
152	22,5W	4579.01/W *	3076	4579.01/WW *	2970
162	24W	A4578.01/160/W	3282	A4578.01/160/WW	3168
172	25,5W	A4578.01/170/W	3487	A4578.01/170/WW	3366
182	27W	A4578.01/180/W	3692	A4578.01/180/WW	3564
192	28,5W	A4578.01/190/W	3897	A4578.01/190/WW	3762
202	30W	A4578.01/200/W	4102	A4578.01/200/WW	3960
212	31,5W	A4578.01/210/W	4307	A4578.01/210/WW	4158
222	33W	A4578.01/220/W	4512	A4578.01/220/WW	4356
232	34,5W	A4578.01/230/W	4717	A4578.01/230/WW	4554
242	36W	A4578.01/240/W	4922	A4578.01/240/WW	4752
252	37,5W	A4578.01/250/W	5128	A4578.01/250/WW	4950
262	39W	A4578.01/260/W	5333	A4578.01/260/WW	5148
272	40,5W	A4578.01/270/W	5538	A4578.01/270/WW	5346
282	42W	A4578.01/280/W	5743	A4578.01/280/WW	5544
292	43,5W	A4578.01/290/W	5948	A4578.01/290/WW	5742
302	45W	A4578.01/300/W	6153	A4578.01/300/WW	5940

* Articolo standard a catalogo
* Standard catalogue item

Sistema d'illuminazione lineare con sorgente LED per installazione a parete, soffitto e sospensione. Corpo in estruso d'alluminio verniciato bianco, dimensionato per poter contenere gli alimentatori.

Linear lighting system fitted with LED technology, for wall, ceiling and suspended use. White painted extruded aluminum profile sized to integrate power supplies.

Système d'éclairage linéaire équipé de technologie LED pour installation à mur, plafond et suspension. Profilé d'aluminium extrudé verni blanc, dimensionné pour pouvoir contenir les convertisseurs.

Sistema de iluminación lineal a pared, techo y suspensión equipado con tecnología LED. Perfil en extrusión de aluminio pintado blanco dimensionado para contener los convertidores.

Lineares Beleuchtungssystem mit LED-Modulen, für Wand-/Deckenmontage oder Aufhängung. Weiß lackiertes Aluminiumprofil mit integriertem Konverter.

Линейная светодиодная система для установки на стену, потолок или с подвесом. Окрашенный в белый цвет экструзионный алюминиевый профиль со встроенным конвертером.

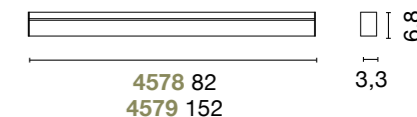

4578

/W Led 12W 1641lm 4000K

/WW Led 12W 1584lm 3000K

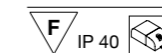

.01/W .01/WW

1,1 kg

4579

/W Led 22,5W 3076lm 4000K

/WW Led 22,5W 2970lm 3000K



.01/W .01/WW

1,5 kg

SU MISURA - CUSTOM SIZE

Tabella lunghezze disponibili a richiesta.
Table of available lengths on request.

cm.	watt	white 4000K (W)	lm	warm white 3000K (WW)	lm
61,5	9W	A4580.01/60/W	1230	A4580.01/60/WW	1188
71,5	10,5W	A4580.01/70/W	1436	A4580.01/70/WW	1386
81,5	12W	4580.01/W *	1641	4580.01/WW *	1584
91,5	13,5W	A4580.01/90/W	1846	A4580.01/90/WW	1782
101,5	15W	A4580.01/100/W	2051	A4580.01/100/WW	1980
111,5	16,5W	A4580.01/110/W	2256	A4580.01/110/WW	2178
121,5	18W	A4580.01/120/W	2461	A4580.01/120/WW	2376
131,5	19,5W	A4580.01/130/W	2666	A4580.01/130/WW	2574
141,5	21W	A4580.01/140/W	2871	A4580.01/140/WW	2772
151,5	22,5W	4580.01/W *	3076	4580.01/WW *	2970
161,5	24W	A4580.01/160/W	3282	A4580.01/160/WW	3168
171,5	25,5W	A4580.01/170/W	3487	A4580.01/170/WW	3366
181,5	27W	A4580.01/180/W	3692	A4580.01/180/WW	3564
191,5	28,5W	A4580.01/190/W	3897	A4580.01/190/WW	3762
201,5	30W	A4580.01/200/W	4102	A4580.01/200/WW	3960
211,5	31,5W	A4580.01/210/W	4307	A4580.01/210/WW	4158
221,5	33W	A4580.01/220/W	4512	A4580.01/220/WW	4356
231,5	34,5W	A4580.01/230/W	4717	A4580.01/230/WW	4554
241,5	36W	A4580.01/240/W	4922	A4580.01/240/WW	4752
251,5	37,5W	A4580.01/250/W	5128	A4580.01/250/WW	4950
261,5	39W	A4580.01/260/W	5333	A4580.01/260/WW	5148
271,5	40,5W	A4580.01/270/W	5538	A4580.01/270/WW	5346
281,5	42W	A4580.01/280/W	5743	A4580.01/280/WW	5544
291,5	43,5W	A4580.01/290/W	5948	A4580.01/290/WW	5742
301,5	45W	A4580.01/300/W	6153	A4580.01/300/WW	5940



Copertura
Polycarbonate screen

0949/200

Schermo 200cm - screen 200cm

0949/300

Schermo 300cm - screen 300cm



Diffusore
Polycarbonate diffuser

0948/200

Diffusore 200cm - Diffuser 200cm

0948/300

Diffusore 300cm - Diffuser 300cm



2 testate di chiusura.
2 closing heads.

0945 .01

* Articolo standard a catalogo
* Standard catalogue item

Elementi di giunzione inclusi.
Joint elements are included.
Elements de jonction inclus.
Verbindungselemente inklusiv.
Elementos de anclaje incluidos.
Соединительные элементы включены.

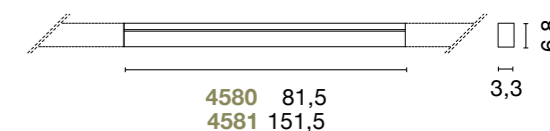

4580

/W Led 12W 1641lm 4000K

/WW Led 12W 1584lm 3000K



.01/W .01/WW

1,1 kg

4581

/W Led 22,5W 3076lm 4000K

/WW Led 22,5W 2970lm 3000K



.01/W .01/WW

1,5 kg

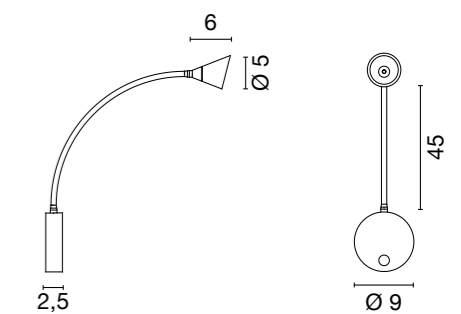

4501 0,3 kg
Led 1W 113lm 3000K
F
.01 .02 .06 .09 .10 .11

Lampade orientabili LED da tavolo o parete con o senza interruttore (4540). Disponibili in bianco o con cono diffusore colorato o totalmente nera.

Lampes orientables de table ou applique avec ou sans interrupteur(4540). Disponible en blanc, en blanc avec diffuseur en couleur ou tout noir.

Lámparas de mesa o pared orientables con o sin interruptor(4540). Acabado blanco, blanco con difusor coloreado o todo negro.

Adjustable table and wall lamps with or without switch (4540). Available in white, white with colored diffuser or all black.

Verstellbare Tisch- oder Wandleuchten mit oder ohne Schalter(4540). Ausführung weiß, weiß mit farbige Kopf oder komplett Schwarz.

Поворотный настенный и настольный светильник с выключателем или без него (4540). В белом цвете или в белом цвете с цветным абажуром или полностью черный.

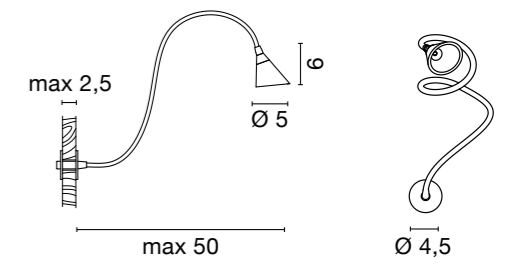

4540 0,2 kg

Led 1W 113lm 3000K



.01 .02 .06 .09 .10 .11

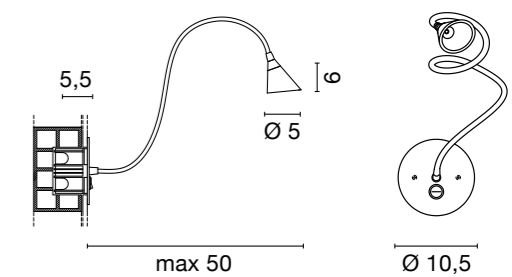

4541 0,3 kg

Led 1W 113lm 3000K



.01 .02 .06 .09 .10 .11

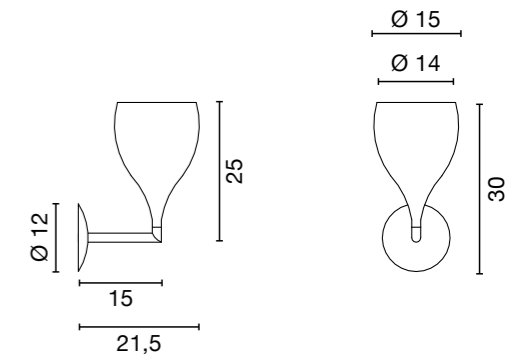

4525 2 kg

Led 17,5W 1550lm 3000K



.01

Lampade da terra e parete a luce indiretta in metallo verniciato bianco.
Piastre LED a tensione di rete 220-240V.

Floor-and wall lamps for indirect lighting in white painted metal.
LED plates for main supply 220-240V.

Lampadaire et applique pour lumière indirecte en métal verni blanc.
Platine LED à tension du réseau 220-240V.

Steh- und Wandleuchte für indirekte Beleuchtung. Gestell aus Weiß lackiertem Metall.
LED-Module zum Betrieb an Netzspannung 220-240V.

Lámpara de pie o aplique para iluminación indirecta de metal pintado blanco.
Platina de LED para tensión de red 220-240V.

Напольная и настольная лампа отраженного света из окрашенного в белый цвет металла.
Светодиодные платы для подключения напрямую к сети 220-240в.

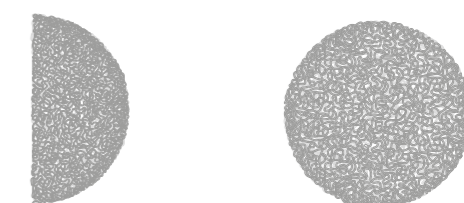
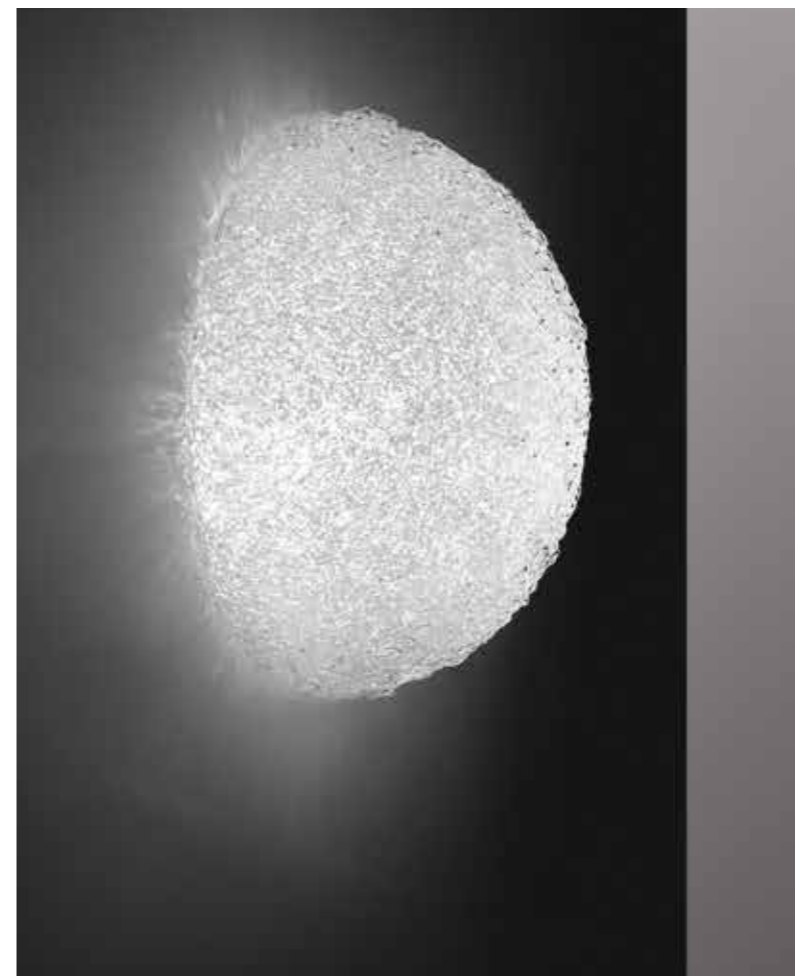

Art. 4533 17
Art. 4534 26

Art. 4533 Ø 34
Art. 4534 Ø 46

4533 2 kg
42W E27 ECO
16W E27 Fluo EL
10W E27 Led (cod. 0105)
F
.00

4534 3,5 kg
53W E27 ECO
16W E27 Fluo EL
10W E27 Led (cod. 0105)
F
.00

Collezione di lampade in filo di metacrilato extra-chiaro colato con tecnologia Flight-Flow.

Collection de lampes en fil de méthacrylate extra-clair coulé selon la technologie Flight-Flow.

Colección de lamparas echas in hilo de metacrilato colado con tecnologia Flight-Flow.

Collection of lamps made of clear poured methacrylate yarn with Flight-Flow technology.

Kollektion Von Leuchten aus Draht aus extraklar Methacrylat verschmolzen mit Flight-Flow Technologie.

Коллекция светильников, изготовленных вручную из прозрачной метакрилатовой нити по технологии Flight-Flow

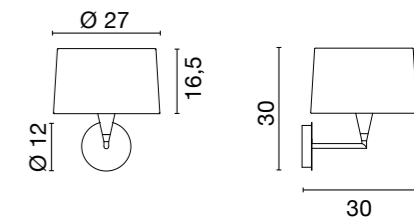

4392	0,7 kg
42W E27 ECO	
16W E27 Fluo EL	
10W E27 Led (cod. 0105)	
F	
.01	

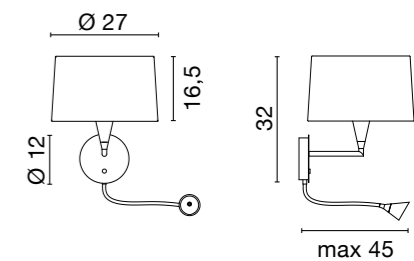

4393 led	1 kg
led 350 mA (1W Dimmerabile - Dimmable) +	
42W E27 ECO	
16W E27 Fluo EL	
10W E27 Led (cod. 0105)	
F	
.01	

Collezione di lampade con struttura in metallo verniciato bianco. Paralume in tessuto tecnico bianco (ignifugo). La versione da parete è disponibile con o senza luce LED da lettura.

Collection de lampes avec structure en métal verni blanc. Abat-jour en tissu technique blanc (ignifugé). L' applique est disponible avec ou sans lampe de lecture LED.

Colección de lamparas con estructura de metal pintado blanco. Sombra de tejido tecnico blanco ignifugo. La aplicae es disponible con o sin luz de lectura con LED.

Collection of lamps, frame in white painted metal. Shade in white technical fabric (fireproof). Wall model is available with or without LED reading light.

Leuchten-Serie mit Gestell aus weiß lackiertem Metall. Schirm aus weißem technischem (feuerfestem) Stoff. Die Wandleuchte ist mit oder ohne LED leseleuchte bestellbar.

Коллекция светильников из белого окрашенного металла. Абажур из белой негорючей ткани. Настенная модель со светодиодным источником света для чтения, или без него.

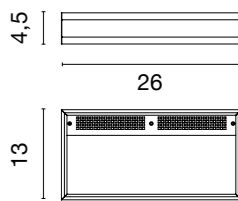

4325 halo 1,1 kg
160W R7s ECO

.01

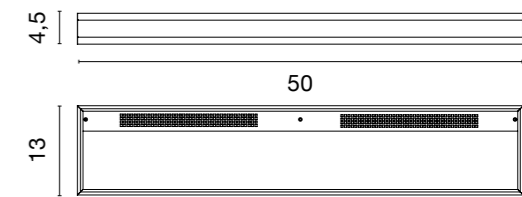

4326 fluo 1,9 kg
36W 2G11



.01

Lampade da parete a luce indiretta in alluminio verniciato bianco.

Wall lamps for indirect lighting, white painted aluminum frame.

Applique pour lumière indirecte, structure en aluminium verni blanc.

Wandleuchte für indirekte Beleuchtung aus weiß lackiertem Aluminium.

Appliques para luz indirecta in aluminio pintado blanco.

Настенный светильник отраженного света из алюминия, окрашенного в белый цвет.

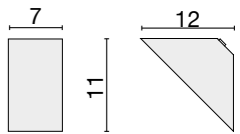

4294 0,4 kg

33W G9 ECO 



4295 0,8 kg

70W E27 Halolux ECO 

16W E27 fluo EL 



.57

Lampade da parete in vetro Pyrex satinato. Struttura in metallo verniciato bianco. Il modello 4295 è utilizzabile ad angolo.

Appliques en verre Pyrex satiné. Structures en métal verni blanc. L'article 4295 est utilisable aussi comme lampe pour coins.

Appliques de vidrio pyrex satinado. Estructura de metal pintado blanco. El model 4295 permite instalacion por esquinas.

Wall lamp in Pyrex satin glass. Body in white painted metal. Model 4295 is also suitable as corner fitting.

Wandleuchten aus satiniertem Pyrex-Glass. Struktur aus weiß lackiertem Metall. Das Modell 4295 erlaubt auch Eckenmontage

Настенный светильник из сатинированного боросиликатного стекла «пирекс». Корпус из белого окрашенного металла. Модель 4295 подходит для углового монтирования.

.57

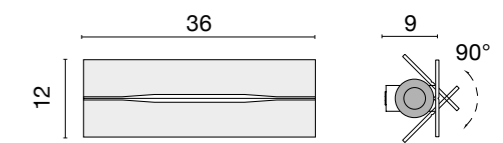

4288 2 kg
120W R7s ECO

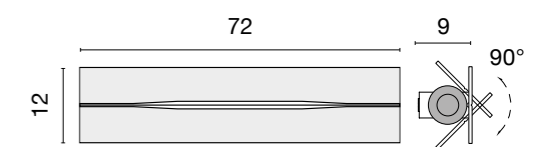

4289 3,5 kg
24W G5 T5



Laverna Business Center - designer: Marina and Ali Urmanchevi - Photo: Anton Balazs

Lampade da parete con schermo orientabile in vetro argentato satinato con incisione a effetto specchio. Supporti in metallo cromato.

Appliques avec écran orientable en verre satiné argenté avec une entaille à effet miroir. Terminales en métal chromé.



Appliques con pantalla orientable in vidrio plateado satinado con grabacione a espejada. Soportes de metal cromado.

Wall lamp with adjustable screen in satin silver glass and mirrored grave. Chromed metal knobs.

Wandleuchten mit ausrichtbarem Schirm aus versilbertem satiniertem Glas und verspiegelte Gravur.

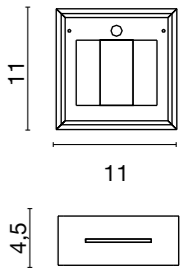
Настенный светильник с поворотным экраном из сатинированного серебристого стекла с зеркальным эффектом. Хромированные кронштейны.

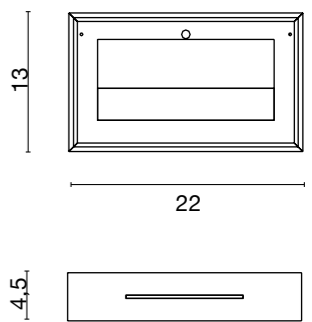

4320 0,5 kg
 33W G9 ECO 

 .57



4321 1,1 kg
 120W R7s (78 mm) ECO 
 .57

Lampade da parete in alluminio cromato con particolari in vetro bianco.

Appliques en aluminium chromé avec détails en verre blanc.

Appliques de aluminio cromado con insertos de vidrio blanco.

Wall lamps in chromed aluminum with details in white glass.

Wandleuchten aus verchromtem Aluminium mit Glasdetail weiß.

Настенный светильник в хромированном алюминии со вставками из белого стекла.

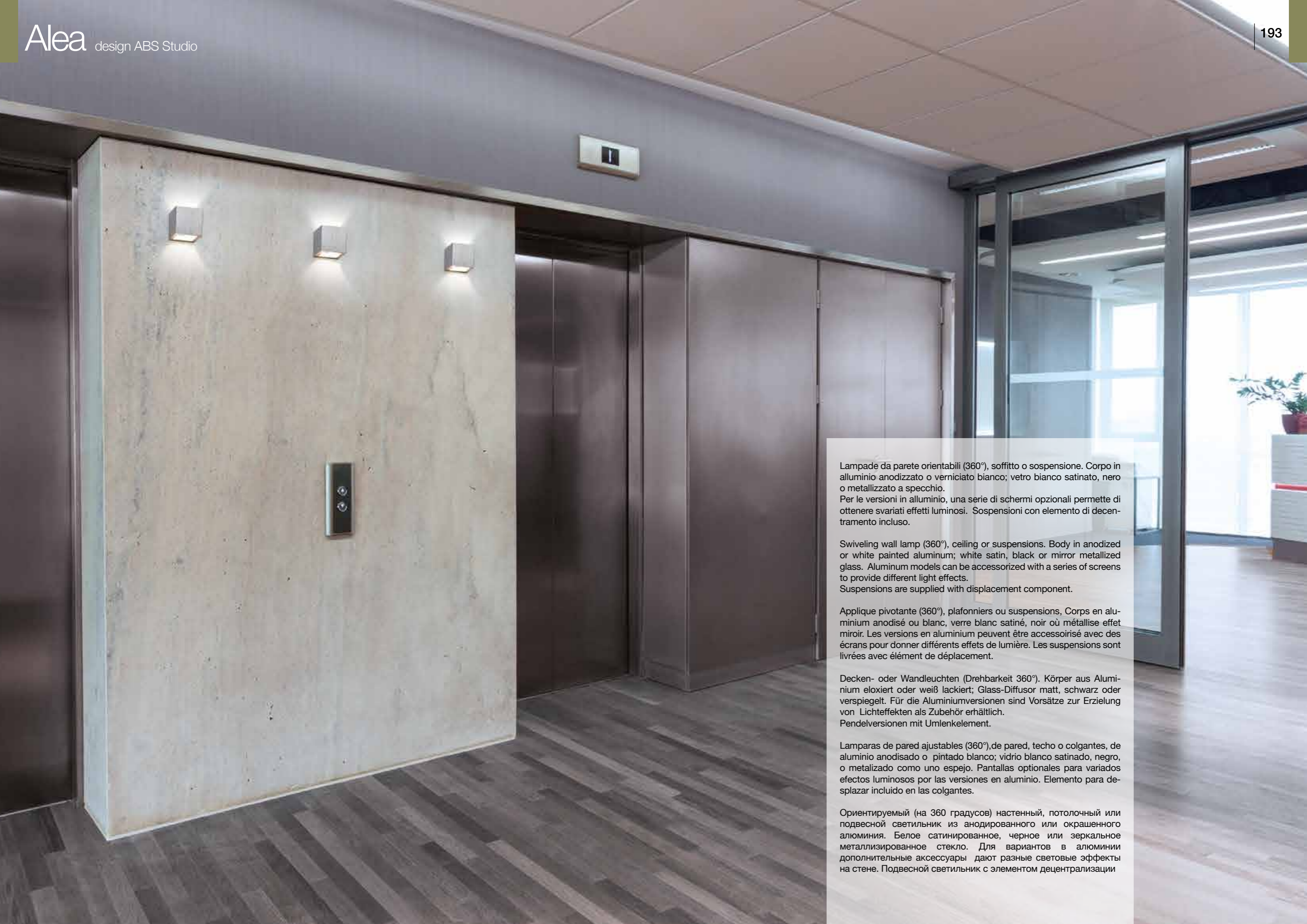

Lampade da parete orientabili (360°), soffitto o sospensione. Corpo in alluminio anodizzato o verniciato bianco; vetro bianco satinato, nero o metallizzato a specchio.

Per le versioni in alluminio, una serie di schermi opzionali permette di ottenere svariati effetti luminosi. Sospensioni con elemento di decentramento incluso.

Swiveling wall lamp (360°), ceiling or suspensions. Body in anodized or white painted aluminum; white satin, black or mirror metallized glass. Aluminum models can be accessorized with a series of screens to provide different light effects.

Suspensions are supplied with displacement component.

Applique pivotante (360°), plafonniers ou suspensions, Corps en aluminium anodisé ou blanc, verre blanc satiné, noir ou métallisé effet miroir. Les versions en aluminium peuvent être accessorisées avec des écrans pour donner différents effets de lumière. Les suspensions sont livrées avec élément de déplacement.

Decken- oder Wandleuchten (Drehbarkeit 360°). Körper aus Aluminium eloxiert oder weiß lackiert; Glass-Diffusor matt, schwarz oder verspiegelt. Für die Aluminiumversionen sind Vorsätze zur Erzielung von Lichteffekten als Zubehör erhältlich.

Pendelversionen mit Umlenkelement.

Lamparas de pared ajustables (360°), de pared, techo o colgantes, de aluminio anodizado o pintado blanco; vidrio blanco satinado, negro, o metalizado como un espejo. Pantallas opcionales para variados efectos luminosos por las versiones en aluminio. Elemento para desplazar incluido en las colgantes.

Ориентируемый (на 360 градусов) настенный, потолочный или подвесной светильник из анодированного или окрашенного алюминия. Белое сатирированное, черное или зеркальное металлизированное стекло. Для вариантов в алюминии дополнительные аксессуары дают разные световые эффекты на стене. Подвесной светильник с элементом децентрализации



.01



.57



.55 off



.55 on

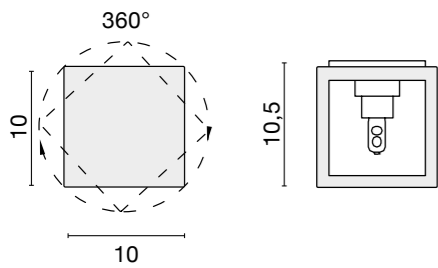

.45



4281 0,5 kg
 20-33-48W G9 ECO
 4W G9 Led
 F



Art. 0187 .01-.45 max 33W ECO



Art. 0189 .01-.45 max 20W ECO



Art. 0205 .01-.45 max 20W ECO

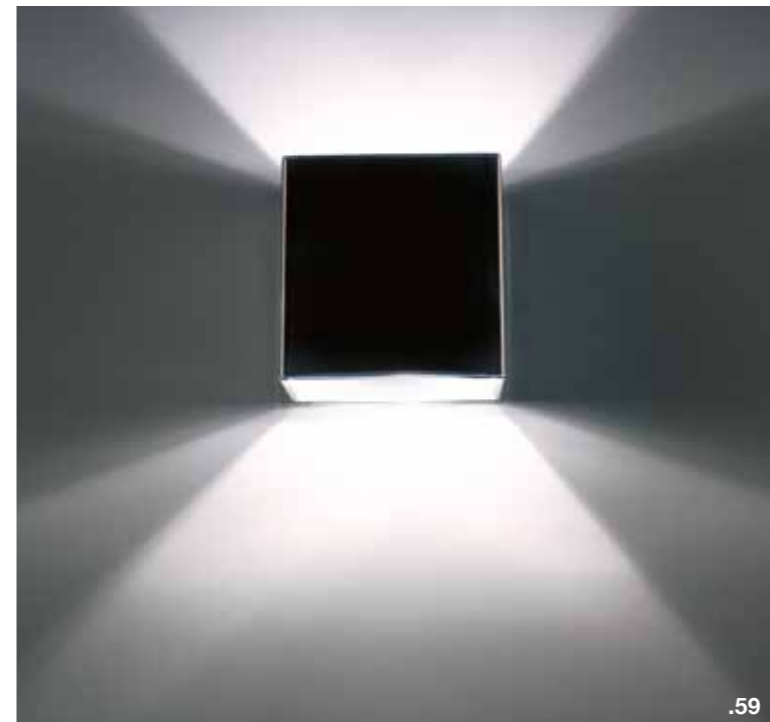

.59

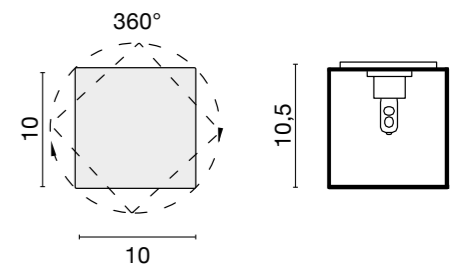

4282 0,6 kg
 48W G9 ECO
 4W G9 Led
 F

.55 .57 .59



Lampade da parete orientabili (360°), soffitto o sospensione. Corpo in alluminio anodizzato o verniciato bianco; vetro bianco satinato, nero o metallizzato a specchio.
Per le versioni in alluminio, una serie di schermi opzionali permette di ottenere svariati effetti luminosi.

Swiveling wall lamp (360°), ceiling or suspensions. Body in anodized or white painted aluminum; white satin, black or mirror metallized glass. Aluminum models can be accessorized with a series of screens to provide different light effects.

Applique pivotante (360°), plafonniers ou suspensions, Corps en aluminium anodisé ou blanc, verre blanc satiné, noir ou métallisé effet miroir. Les versions en aluminium peuvent être accessorisées avec des écrans pour donner différents effets de lumière.

Decken- oder Wandleuchten (Drehbarkeit 360°). Körper aus Aluminium eloxiert oder weiß lackiert; Glass-Diffusor matt, schwarz oder verspiegelt. Für die Aluminiumversionen sind Vorsätze zur Erzielung von Lichteffekten als Zubehör erhältlich.

Lamparas de pared ajustables (360°), de pared, techo o colgantes, de aluminio anodizado o pintado blanco; vidrio blanco satinado, negro, o metalizado como uno espejo. Pantallas opcionales para variados efectos luminosos por las versiones en aluminio.

Ориентируемый (на 360 градусов) настенный, потолочный или подвесной светильник из анодированного или окрашенного алюминия. Белое сатирированное, черное или зеркальное металлизированное стекло. Для вариантов в алюминии дополнительные аксессуары дают разные световые эффекты на стене.



.45



.57



.55 off

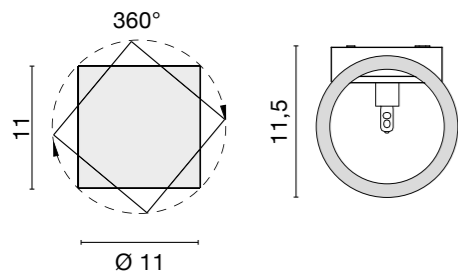

4286 0,5 kg

20-33-48W G9 ECO



4287 0,5 kg

48W G9 ECO



.01 .45



Art. 0186 .01-.45 max 33W ECO



Art. 0188 .01-.45 max 20W ECO



Art. 0204 .01-.45 max 20W ECO



.55 on

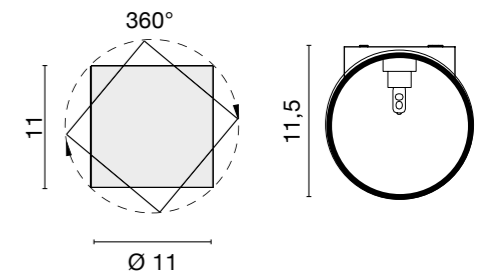

4287 0,5 kg

48W G9 ECO



.55 .57 .59

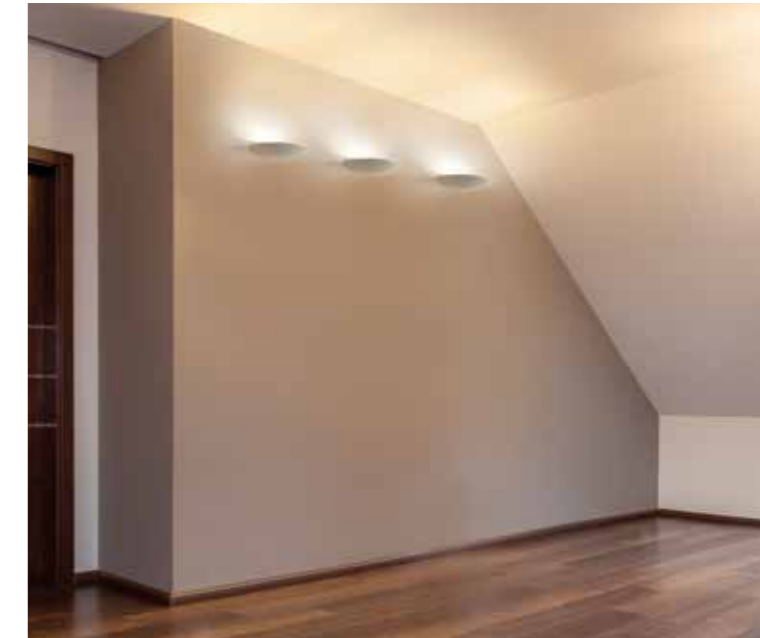

Lampade da parete e terra in metallo, finiture: ottone lucido, nickel satinato o verniciato bianco. Versione da terra alogena con dimmer. Con piastre LED a tensione di rete 220-240V.

Wall and floor lamps in metal; Finishes: polished brass, nickel matt or white varnished. Halogen floor lamp with dimmer. With LED plates for main supply 220-240V.

Appliques et lampadaire en métal, finition: laiton poli, nickel satiné ou verni blanc. Lampadaire halogène avec variateur. Avec Platine LED à tension du réseau 220-240V.

Wand- und Stehleuchten aus Metall. Ausführungen: Messing poliert, Nickelmatt oder weiß lackiert. Halogen Stehleuchte ist mit dimmer. Mit LED-module zum Betrieb an Netzspannung 220-240V.

Lamparas de pared y de pie de metal. Acabado: laton pulido, niquel-mat o pintado blanco. Version de pie halogena es con dimmer. Con platina de LED para tension de red 220-240V.

Настенный или напольный светильник из металла: полированной латуни, матированного никеля или белого. Торшер с галогеновой лампой с диммером. Со светодиодной платой, подключаемой в сеть 220-240в

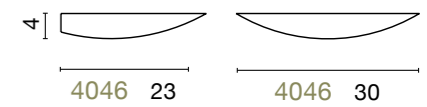

4046 0,9 kg
230W R7s ECO

.01 .20 .32

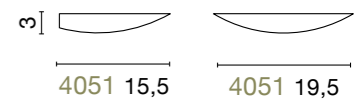

4051 miniolimpia 0,4 kg
120W R7s (78 mm) ECO

.01 .20 .32

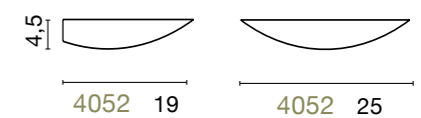

4052 led 0,9 kg

Led 17,5W 1550lm 3000K



.01/WW .20/WW .32/WW

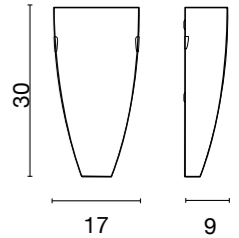

4021	0,9 kg
70W E27 ECO	
24W E27 Fluo EL	
10W E27 Led (cod. 0105)	
.57	

4542 led	1,2 kg
Led 13W 1010lm 3000K	
.57/WW	

Optional:
0009/P
Griglia di protezione.
Protection net.

Optional:
0009/G
Griglia di protezione.
Protection net.

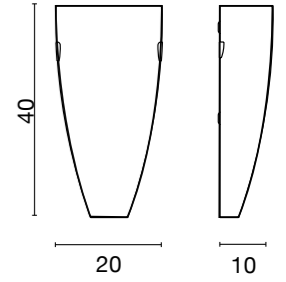

4023	1,5 kg
70W E27 ECO	
24W E27 Fluo EL	
10W E27 Led (cod. 0105)	
.57	

4543led	1,50 kg
Led 13W 1010lm 3000K	
.57/WW	

Lampade da parete in vetro soffiato satinato bianco con particolari cromati.
Con piastre LED a tensione di rete 220-240V.

Appliques en verre soufflé satiné blanc avec détails chromés.
Avec Platine LED à tension du réseau 220-240V.

Appliques de vidrio soplado satinado blanco con detalles cromados.
Con platina de LED para tension de red 220-240V.

Wall lamps in white blown glass with chromed details.
With LED plates for main supply 220-240V.

Wandleuchten aus geblasenem satiniertem Glas. Metallteile: verchromt.
Mit LED-Module zum Betrieb an Netzspannung 220-240V.

Настенный светильник из белого дутого стекла. Детали из хромированного металла.
Со светодиодной платой, подключаемой в сеть 220-240в

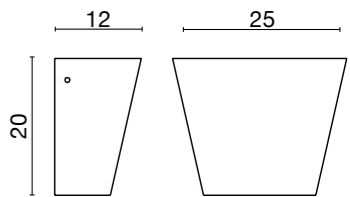

4209	1,3 kg
70W E27 ECO	
16W E27 Fluo EL	
10W E27 Led (cod. 0105)	
F	
.57	

4553 led	1,00 kg
Led 13W 1010lm 3000K	
F	
.57/WW	

Lampade e parete in vetro soffiato satinato bianco.
Con piastre LED a tensione di rete 220-240V.

Appliques en verre soufflé satiné opale.
Avec Platine LED à tension du réseau 220-240V.

Appliques de cristal curvado satinado blanco.
Con platina de LED para tension de red 220-240V.

Wall lamps in white blown glass.
With LED plates for main supply 220-240V.

Wandleuchten aus mundgeblasenem Mattglas opal.
Mit LED-module zum Betrieb an Netzspannung 220-240V.

настенный светильник из белого или цветного дутого стекла.
Со светодиодной платой, подключаемой в сеть 220-240в



Optional:
0006

Due griglie di protezione.
Two protection grids.

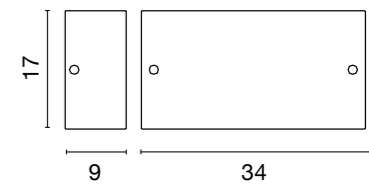

4178 2 kg

120W R7s ECO



.57

4378 fluo 2 kg

2x26W G24 q.3



.57

4548 led 1,50 kg

Led 13W 1010lm 3000K



.57/WW

Lampada da parete in vetro curvato satinato bianco. Particolari in metallo nickel lucido inclusi. 2 griglie di protezione disponibili come accessorio (Art.0006). Con piastre LED a tensione di rete 220-240V.

Wall lamp in curved white satin glass. Metal details in polished nickel included. 2 protection grids are available as accessory (Art.0006). With LED plates for main supply 220-240V.

Applique en verre incurvé satiné blanc. Détails en métal nickelé poli inclus. 2 grilles de protection sont disponibles comme accessoire (Art.0006). Avec Platine LED à tension du réseau 220-240V.

Wandleuchte mit Diffusor aus gebogenem Satin-glas, Ausuferung weiß. Inklusiv Metallteile in Nickel poliert. Als Zubehör sind 2 Schutzgitter bestel-lbar(Art.0006). Mit LED-module zum Betrieb an Netzspannung 220-240V.

Appliques de vidrio curvado, difusor blanco. Detalles en niquel brillo incluidos 2 grillas de proteccion son disponibles como accesorio (Art.0006). Con platina de LED para tension de red 220-240V.

Настенный светильник из гнутого матового белого стекла. Детали из полированного никеля.Как аксессуар: защитная решетка (арт.0006). Со светодиодной платой, подключаемой в сеть 220-240в



Lampade da parete in vetro soffiato satinato bianco. Art. 4098 per applicazione ad angolo. Con piastre LED a tensione di rete 220-240V.

Appliques en verre soufflé satiné blanc Art. 4098 pour installation angulaire. Avec Platine LED à tension du réseau 220-240V.

Appliques de cristal soblado blanco satinado. Art. 4098 para montaje en esquina. Con platina de LED para tensión de red 220-240V.

Wall lamps in satin blown glass, white. Art. 4098 corner fitting. With LED plates for main supply 220-240V.

Wandleuchten aus mundgeblasenem Satinglas weiß. Art. 4098 zur Winkelmontage. Mit LED-module zum Betrieb an Netzspannung 220-240V.

Настенный светильник из дутого матового стекла. Арт 4098 для углового монтирования. Со светодиодной платой, подключаемой в сеть 220-240в

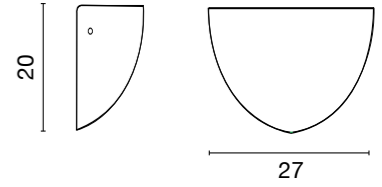

4098 drim angolo 1,6 kg
 70W E27 ECO
 10W E27 Led (cod. 0105)
 F
 .57

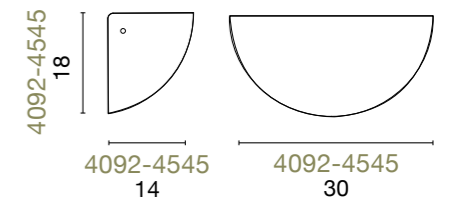

4092 1,1 kg
 100W E27 Halolux ECO
 24W E27 Fluo EL
 10W E27 Led (cod. 0105)
 F
 .57

4545 led 1,00 kg
 Led 10W 1200lm 3000K
 F
 .57/WW

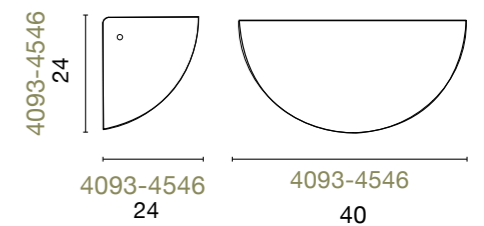

4093 1,9 kg
 100W E27 Halolux ECO
 24W E27 Fluo EL
 10W E27 Led (cod. 0105)
 F
 .57

4546 led 1,80 kg
 Led 10W 1200lm 3000K
 F
 .57/WW

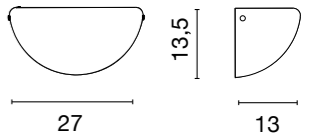

4249	1,5 kg
42W E27 ECO	
21W E27 Fluo EL	
10W E27 Led (cod. 0105)	
F IP 43	
.57	

4549 led	1,00 kg
Led 10W 1200lm 3000K	
F IP 43	
.57/WW	

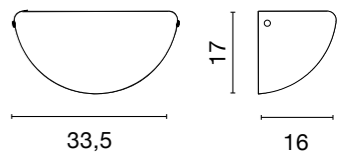

4251	2,2 kg
52W E27 ECO	
21W E27 Fluo EL	
10W E27 Led (cod. 0105)	
F IP 43	
.57	

4550 led	1,80 kg
Led 10W 1200lm 3000K	
F IP 43	
.57/WW	

Lampade da parete in vetro soffiato bianco satinato. Con piastre LED a tensione di rete 220-240V.

Appliques en verre soufflé satiné blanc. Avec Platine LED à tension du réseau 220-240V.

Appliques de cristal soblado satinado blanco. Con platina de LED para tension de red 220-240V.

Wall lamps in white satin blown glass. With LED plates for main supply 220-240V.

Wandleuchten aus weißem mundgeblasenes Satinglas. Mit LED-module zum Betrieb an Netzspannung 220-240V.

Потолочный, или настенный светильник из дутого белого матового стекла. Со светодиодной платой, подключаемой в сеть 220-240в

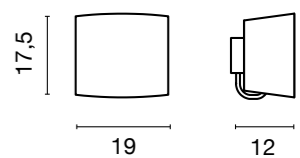

4175 minipathos

1,2 kg

42W E14 ECO



.54 .57 .60

Lampade da parete in vetro soffiato satinato bianco o colorato; strutture verniciate in bianco.

Appliques en verre soufflé satiné opale ou coloré; structures vernies en blanc.

Appliques de cristal soplado satinado blanco o colorado. Cuerpo pintado en blanco.

Wall lamps in white or colored blown glass, white painted frames.

Wandleuchten aus mundgeblasenem Glas: Opal oder farbig; Gestell weiss lackiert.

Настенный светильник из белого или цветного дутого стекла. Металлические детали окрашены в белый цвет.

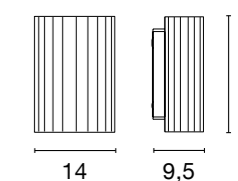

4265 1,4 kg
120W R7s (78 mm.) ECO



.50

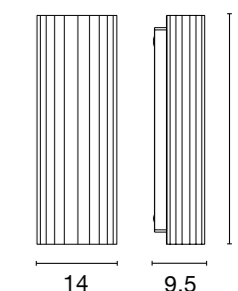

4266 3,3 kg
2x80W R7s (78 mm.) ECO



.50

Lampade a sospensione e parete con struttura in metallo.
Doppio diffusore esterno in vetro pyrex trasparente, interno satinato.

Suspension and wall lamps with metal structure.
Double diffuser outer in transparent Pyrex glass, internal diffuser matt.



Suspensions et appliques avec structure en métal.
Double diffuseurs : extérieur en pyrex transparent et intérieur en satiné.

Pendel Wand/Leuchten mit Struktur aus Metall.
Doppel Diffusor: Außen aus Klarem Pyrexglass und Innere satiniert.

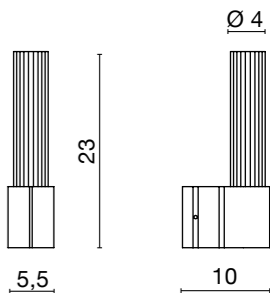
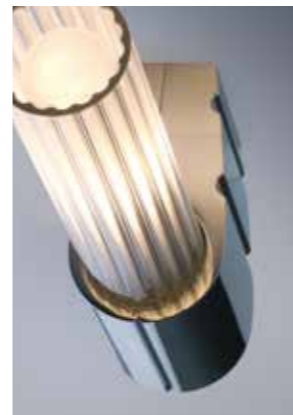

Colgantes y lamparas de pared, cuerpo de metal.
Doble difusor: exterior en vidrio pyrex transparente y interior satinado.

Подвесной, настенный светильник с корпусом из металла. Внешний диффузор из прозрачного матового стекла пирекс, внутренний матовый.

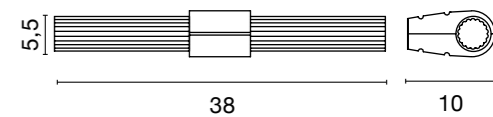

4259 0,6 kg
 48W G9 ECO 
  IP 40
 .31



4260 0,8 kg
 2x48W G9 ECO 
  IP 40
 .31

Lampade da parete in metallo cromato. Doppio diffusore in vetro pirex esterno trasparente e interno satinato. Art. 4260 Solo per installazione orizzontale.

Wall lamps in chromed metal. Double diffuser of borosilicate glass: outer clear and inner satin. Art. 4260 Only for horizontal installation.

Appliques en métal chromé. Double diffuseur en verre borosilicate : extérieur transparent et intérieur satiné. Art. 4260 Seulement pour installation horizontale.

Wandleuchten aus verchromtem Metall. Diffusor aus Pirex klar und Mattglas. Art. 4260 Solo para instalación horizontal.

Aplicque en metal cromado. Difusor en vidrio Pyrex. Transparente y satinado. Art. 4260 Nur für horizontale Installation.

Настенный светильник в хромированном металле. Внешний диффузор из прозрачного и внутренний из матового боросиликатного стекла пирекс. Арт. 4260 только для горизонтальной установки.

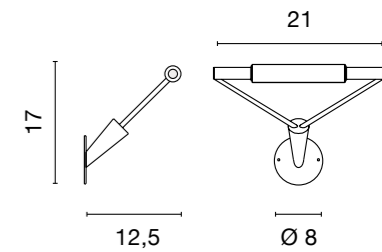

4137 miniteda 0,6 kg

120W R7s (78mm.) ECO 

F IP 40

.22 .32

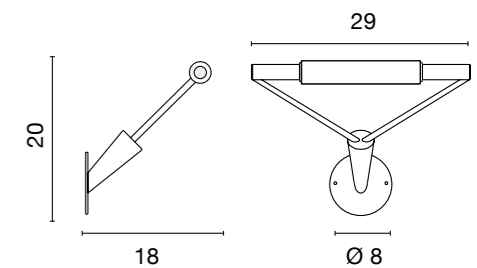

4138 1 kg

160W R7s ECO 

F IP 40

.22 .32

Lampade da parete e soffitto, struttura in ottone, cromato o nickel satinato. Diffusore in Pirex serigrafato.

Appliques et plafonniers, structure en laiton, chromé ou nickel satiné. Diffuseur en Pyrex sérigraphié.

Lamparas de pared y de techo de latón cromado o níquel satinado. Difusor de vidrio pyrex serigrafado.

Wall and ceiling lamps, brass structure, chromed or nickel matt. Silkscreened Pirex glass diffuser.

Wand- und Deckenleuchten, Struktur aus Messing, verchromt oder nickelmatt. Reflektor aus siebdrucktem Pirexglas.

Настенные и потолочные светильники из цвета латунь, хром или матовый никель. Диффузор из боросиликатного стекла пирекс с узором.

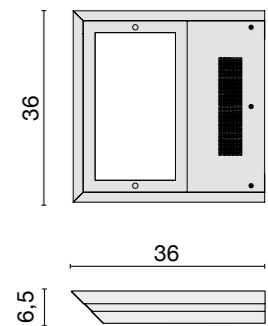

4271 6 kg

70W RX7s



.40

4272 6 kg

150W RX7s



.40

4273 5,5 kg

230W R7s ECO



.40

Lampade da parete per lampadine a ioduri metallici o alogene lineari. Struttura in alluminio verniciato grigio brillante.

Appliques pour lampes à iodures métalliques ou halogènes. Structure en aluminium gris brillant.

Appliques para bombillas de halogenuros metálicos o halógenas. Cuerpo en aluminio pintado gris brillante.

Wall lamps for metal halide or halogen linear bulbs. Frame in bright grey painted aluminum with.

Wandleuchten für Halogenmetaldampflampen oder Halogen Stablampen. Struktur aus brillian-tgrau lackiertem Aluminium.

Настенный светильник из окрашенного в серый блестящий цвет алюминия. Галогеновый или металлогалогеновый источник света.

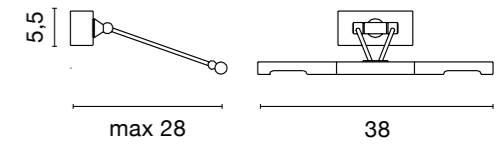
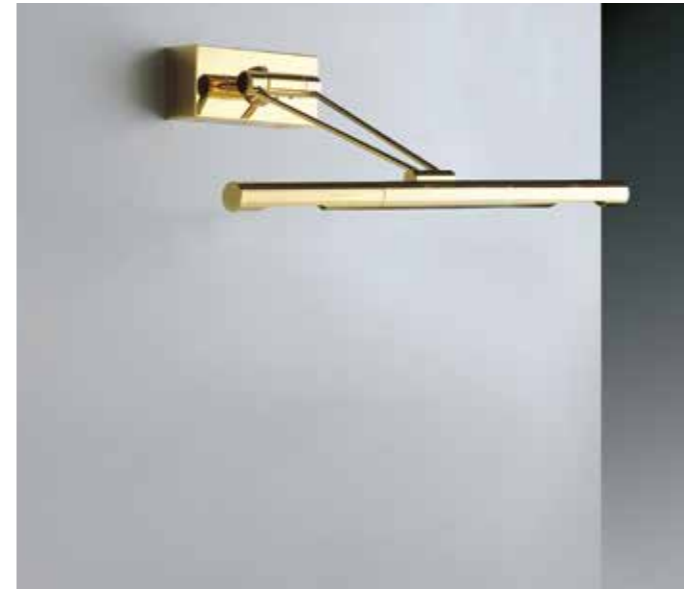

4156 Ikon 1,2 kg
 12V 2x20W G4
 F
 .21 .22 .26 .32

4504 Ikon Led 1,2 kg
 Led 2,8W 320lm 3000K
 F
 .21 .22 .32

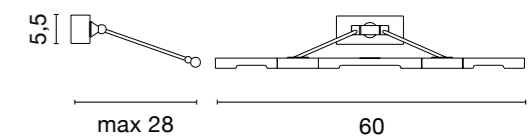

4155 Ikon Maxi 1,9 kg
 12V 4x20W G4
 F
 .21 .22 .26 .32

Lampade da parete orientabili, in alluminio e ottone. Disponibili in ottone dorato 24K, cromo, bronzo antico e nickel.

Appliques orientables en aluminium et laiton. Disponibles en finition doré 24K, chromé, bronze ancien ou nickel mat.

Appliques orientables en latón y aluminio. Disponibles en acabado dorado 24K, cromo, bronzo antiguo y níquel.

Adjustable wall lamps in aluminum and brass. Available in 24K gold, nickel matt, dark bronze or chromed finish.

Verstellbare Wandleuchten aus Aluminium und Messing. Ausführung Gold 24 K, Chrom, antin bronze und Nickel.

Поворотный настенный светильник в алюминии и латуни. Позолоченный 24к, хромированный, состаренной бронзы или никелированный.

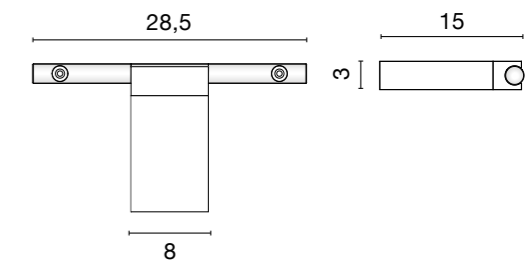

Lampada da parete orientabile in alluminio verniciato bianco e cromato.

Applique orientable en aluminium verni blanc et chrome.

Applique orientable en aluminio pintado blanco y cromado.

Adjustable wall lamp in white lacquered and chromed aluminum.

Verstellbare Wandleuchte aus Aluminium weiß lackiert und verchromt.

Поворотный настенный светильник из белого и хромированного алюминия.

4503 0,6 kg

Led 2,8W 320lm 3000K



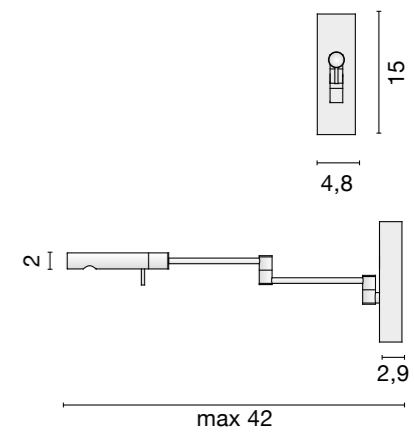

Lampada da parete orientabile in alluminio e ottone. Disponibile in dorato 24K, cromo e nickel.

Applique orientable en aluminium et laiton. Disponible en finition dore 24K, chromé ou nickel mat.

Applique orientable en latón y aluminio. Disponible en acabado dorado 24K, cromo y níquel.

Adjustable wall lamp in aluminum and brass. 24Kgold, nickel matt or chromed finish.

Verstellbare Wandleuchte aus Aluminium und Messing. Ausführung Gold 24K, Chrom und Nickel.

Поворотный настенный светильник в алюминии и латуни. Позолоченный 24K, хромированный или никелированный

4505 0,9 kg

Led 1,4W 160lm 3000K



.21 .22 .32

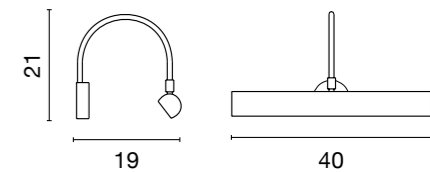

4195 1,1 kg
 2x25W E14 ECO
 2x8W E14 Fluo EL

F
 .20 .22

Lampada da parete orientabile in ottone lucido o cromato.

Applique orientable en laiton poli ou chromé.

Applique orientable en latón pulido o cromado.

Adjustable wall lamp, in brass: polished or chromed.

Verstellbare Wandleuchte aus Messing: poliert oder verchromt.

Настенный ориентируемый светильник из хромированной или полированной латуни.

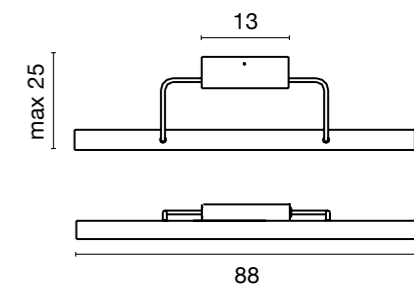

4007	1,5 kg
4x25W E14 ECO	
4x8W E14 Fluo EL	
F	
.20 .22	

Lampada da parete orientabile in ottone lucido o cromato.

Applique orientable en laiton poli ou chromé.

Applique orientable en latón pulido o cromado.

Adjustable wall lamp, in brass: polished or chromed.

Verstellbare Wandleuchte aus Messing: poliert oder verchromt.

Настенный ориентируемый светильник из хромированной или полированной латуни.

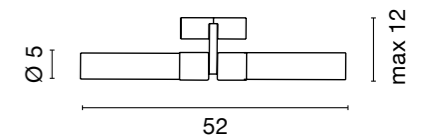

Lampada da parete orientabile in ottone cromato, con interruttore. Diffusori in vetro soffiato opale. Solo per installazione orizzontale.

Applique orientable en laiton chromé, avec interrupteur. Diffuseurs en verre opale soufflé. Seulement pour installation horizontale.

Applique ajustable de laton cromado con interruptor. Difusores en cristal soblado blanco opal. Solo para instalación horizontal.

Adjustable wall lamp, in chromed brass, with switch. Opal glass blown diffusers. Only for horizontal installation.

Verstellbare Wandleuchte aus Messing verchromt mit Schalter. Reflektoren aus geblasenem Opalglas. Nur für horizontale Installation.

Поворачивающийся настенный светильник из хромированной латуни, с выключателем. Диффузор из опалового дутого стекла. Только для горизонтальной установки.

4133

1,7 kg

2x40W E14 ECO

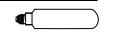

2x8W E14 Fluo EL



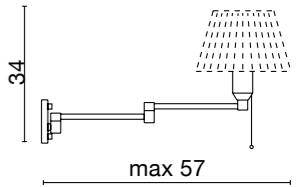

4004	1,7 kg
42W E27 ECO	
16W E27 Fluo EL	
10W E27 Led (cod. 0105)	
F	
.21	

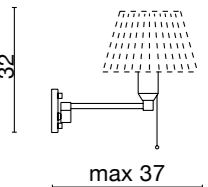

4006	1,5 kg
42W E27 ECO	
16W E27 Fluo EL	
10W E27 Led (cod. 0105)	
F	
.21	

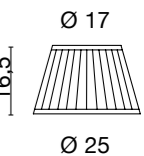

8001	0,25 kg
Paralume in tessuto a pieghe avorio ignifugo	
Pleated ivory not inflammable cloth shade	

Lampade da terra, tavolo e parete estensibile in ottone dorato 24K con interruttore. Paralume in tessuto ignifugo a pieghe color avorio (8001). Versione da terra regolabile anche in altezza.

Extensible floor, table and wall lamps with switch, finish in gold plated 24K. Shade in pleated fireproof cloth ivory color(8001). The floor lamp height is adjustable.

Lampadaire, lampe de table et appliques extensibles avec interrupteur, finition laiton doré 24K. Abat-jour en tissu plissé ignifuge couleur ivoire (8001). Lampadaire réglable aussi en hauteur.

Schwenkbare Steh-, Tisch- und Wandleuchten aus 24K vergoldetem Messing. Schirm aus plisziertem Elfenbeinfarbigem feuerfestem Stoff (8001). Die Stehleuchte ist auch höhenverstellbar.

Lampara de pie adjustable, de sobremesa y apliques extensibles de latón dorado 24K. Con interruptor. Pantalla en tejido plisado ininflamable color marfil (8001). La versión de pie se arregla también en altura.

Настенный поворачивающийся светильник, торшер и настольная лампа из позолоченной латуни (24K). С выключателем. Абажур из огнестойкой плиссированной ткани (цвет – слоновая кость) (8001). Торшер регулируемой высоты.

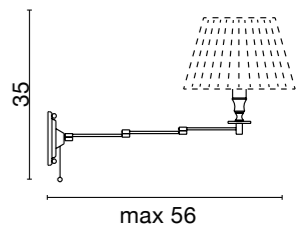

4005	1,6 kg
42W E27 ECO	
12W E27 Fluo EL	
10W E27 Led (cod. 0105)	

F
.20 .26

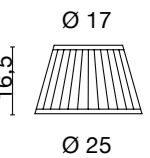

8001	0,25 kg
Paralume in tessuto a pieghe avorio ignifugo	
Pleated ivory not inflammable cloth shade	

Lampada da terra, tavolo e parete orientabile ed estensibile in ottone lucido o bronzo antico. Paralume in tessuto ignifugo a pieghe color avorio (8001). Versione da terra regolabile in altezza.

Extensible and adjustable floor, table and wall lamps in polished brass and dark bronze. Shade in pleated fireproof cloth ivory color (8001). The floor lamp height is adjustable.

Lampadaire, lampe de table et applique extensibles et réglable en laiton poli ou bronze ancien. Abat-jour en tissu plissé ignifuge couleur ivoire (8001). Lampadaire réglable en hauteur.

Steh-, Tisch und Wandleuchte: schwenkbar und extensibel, aus Messing poliert oder antik Bronze mit plissiertem feuerfestem elfenbeinfarbenem Schirm (8001). Höhenverstellbare Stehleuchte.

Lampara de pie, de sobremesa y apliques extensibles de latón dorado o bronce antiguo. Pantalla en tejido plisado ininflamable color marfil (8001). La versión de pie se arregla también en altura.

Поворотные бра, торшер и настольная лампа из полированной латуни или состаренной бронзы. Абажур из огнестойкой плиссированной ткани цвета слоновой кости (8001). Торшер регулируемой высоты.

Parete/Soffitto - Wall/Ceiling



Disco 294



Drum 244



Echo 290



Flan 256



Flip 284



Flip Maxi 286



Frida 282



Fusion 292



Helios 274



Kappa 252

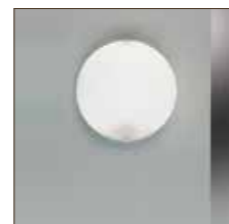

Luna 296

Magnum
Quadro 262Magnum
Tondo 260

Minipin 288



Mirò 270



Musa 278



Quadrapin 288



Rail 246



Ringo 280



Roc 240



Sail 268



Tondapin 288



Trandy 264

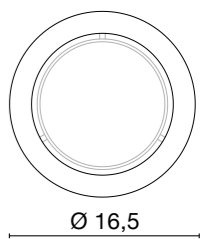
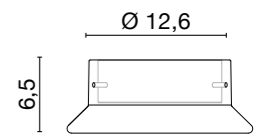

5539 1,5 kg

Led 8,7W 670lm 3000K

F IP65

.01/WW

Lampada da esterno IP65 per installazione a soffitto/parete. Corpo in alluminio anodizzato e verniciato bianco, schermo in metacrilato opalino. Diffusore in vetro pressato extra-chiaro lucidato. Modulo LED da 700Lm a tensione di rete 220/240V di ultima generazione.

Ceiling/wall lamp IP65 for outdoor use. Aluminum body is anodized and white painted, opal methacrylate screen. Polished pressed extra-clear glass diffuser. The lamp is fitted with 700lm latest generation LED plate for main supply 220-240V.

Lampe plafond/mur IP65 pour usage extérieur. Corps en aluminium anodisé et verni blanc, écran de méthacrylate opalin. Diffuseur en verre pressé poli extra-clair. Module LED 700Lm LED à tension du réseau 220-240V de nouvelle génération.

Wand- und Deckenleuchte für Außenbereiche mit Schutzart IP65. Gehäuse aus eloxiertem und weiß lackiertem Aluminium, Schirm aus opalisiertem Acrylglas. Diffusor aus Pressglas, extraklar und poliert. Die Leuchte ist ausgestattet mit einem 700lm LED-Modul neuester Generation für Netzspannung 220-240V.

Lámpara de techo/pared IP65 para exteriores. Cuerpo de aluminio anodizado y pintado blanco. Pantalla de metacrilato opalino y difusor de cristal prensado extra claro pulido. La lámpara está equipada con módulo LED 700Lm de última generación para tensión de red 220-240V.

Потолочный/настенный светильник для наружного использования IP65. Анодированный алюминий, окрашен в белый цвет. Рассеиватель из матового метакрилата. Диффузор из сверхяркого стекла. Светодиод на плате последнего поколения 700лм для подключения в сеть 220в.

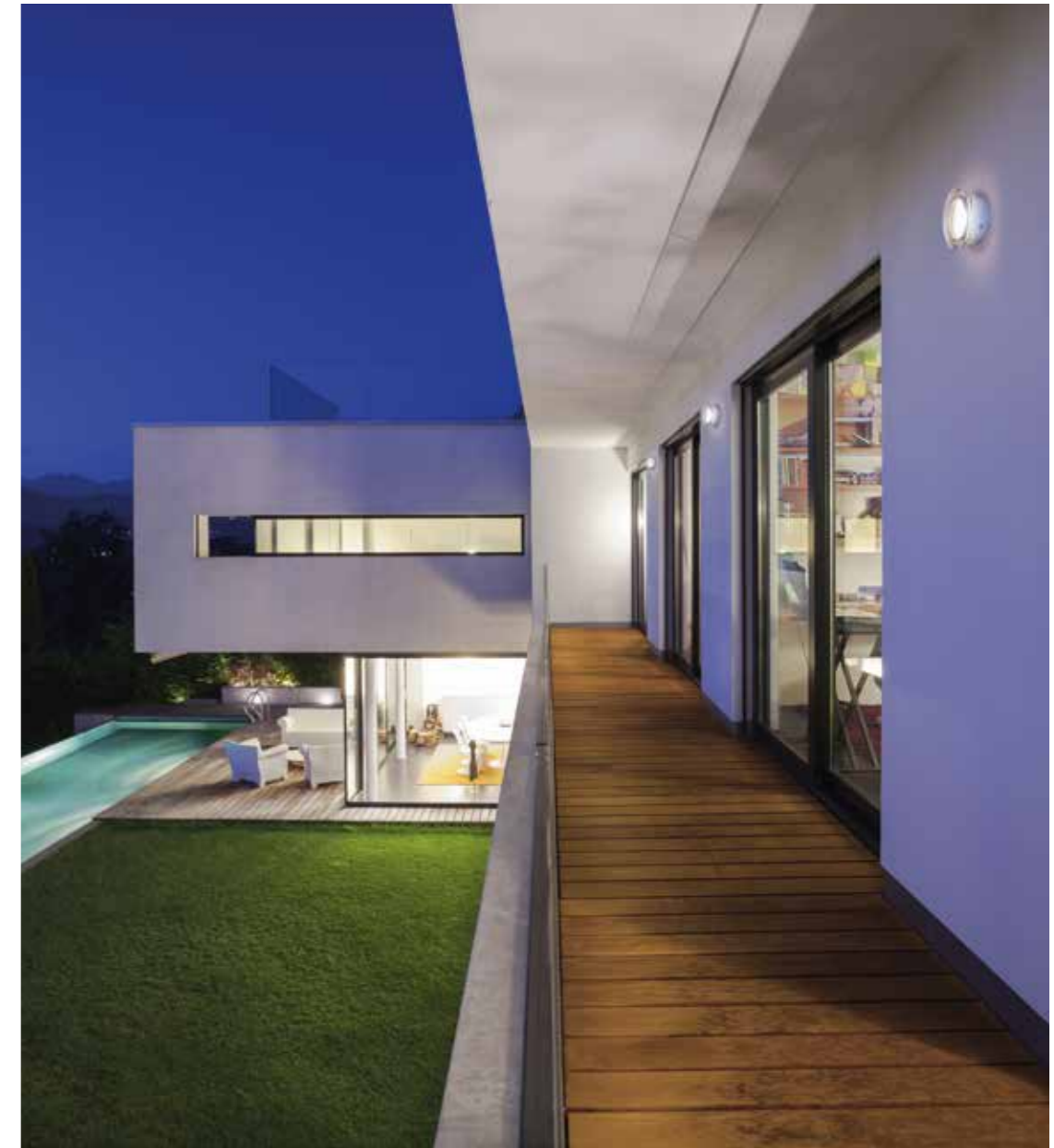
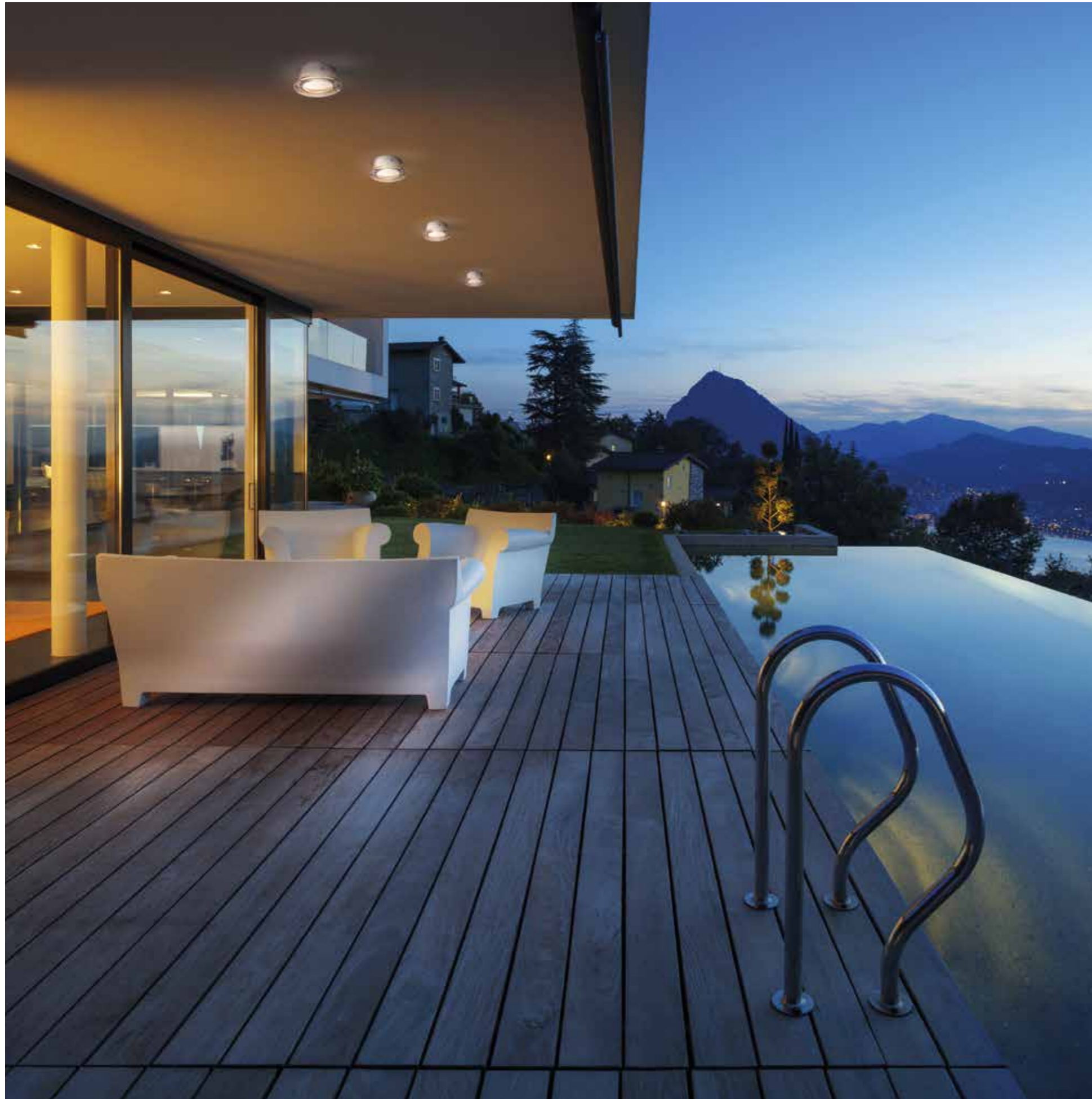

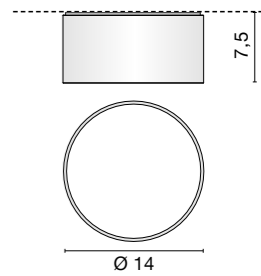

5520 1,1 kg
 10W 1200lm 3000K
 F IP65
 .01/WW .45/WW

Lampada LED da plafone o parete IP65 in alluminio anodizzato (anodizzazione rinforzata per esterni) o verniciato bianco e diffusore in metacrilato. Modulo LED 10W 220-240V.

Wall or ceiling LED lamp IP 65, aluminium body in anodized (reinforced anodizing for outdoor) or white painted finish. Metachrilate diffuser. 10W LED module 220-240V.

Applique ou plafonnier LED IP 65, corps en aluminium anodisé (anodisation renforcée pour l'extérieur) ou verni blanc et diffuseur en metachrilate satiné. Module LED 10W 220-240V.

Wand- oder Deckenleuchte LED IP65, Körper aus Aluminium eloxiert (verstärktem Eloxierung für Außenbereich) oder weiß lackiert. Metakrilat Diffusor matt. LED Modul 10W 220-240V.

Lampara LED de pared y de techo IP65, estructura en aluminio anodizado (anodisacion reforzada para exterior) o pintada blanca y difusor en metacrilato satinado. Modulo LED 10W 220-240V.

Потолочный или настенный светильник со степенью защиты IP65 из алюминия с усиленным анодированием для наружного использования или окрашенный в белый цвет. Диффузор из матового метакрилата. Светодиодный модуль 10 ватт для подключения в сеть 220-240в.



SU MISURA - CUSTOM SIZE

Tabella lunghezze disponibili a richiesta.
Table of available lengths on request.

cm.	watt	white 4000K (W)	lm	warm white 3000K (WW)	lm
62	9W	A5540.01/60/W	1230	A5540.01/60/WW	1188
72	10,5W	A5540.01/70/W	1436	A5540.01/70/WW	1386
82	12W	5540.01/W *	1641	5540.01/WW *	1584
92	13,5W	A5540.01/90/W	1846	A5540.01/90/WW	1782
102	15W	A5540.01/100/W	2051	A5540.01/100/WW	1980
112	16,5W	A5540.01/110/W	2256	A5540.01/110/WW	2178
122	18W	A5540.01/120/W	2461	A5540.01/120/WW	2376
132	19,5W	A5540.01/130/W	2666	A5540.01/130/WW	2574
142	21W	A5540.01/140/W	2871	A5540.01/140/WW	2772
152	22,5W	5541.01/W *	3076	5540.01/WW *	2970
162	24W	A5540.01/160/W	3282	A5540.01/160/WW	3168
172	25,5W	A5540.01/170/W	3487	A5540.01/170/WW	3366
182	27W	A5540.01/180/W	3692	A5540.01/180/WW	3564
192	28,5W	A5540.01/190/W	3897	A5540.01/190/WW	3762
202	30W	A5540.01/200/W	4102	A5540.01/200/WW	3960
212	31,5W	A5540.01/210/W	4307	A5540.01/210/WW	4158
222	33W	A5540.01/220/W	4512	A5540.01/220/WW	4356
232	34,5W	A5540.01/230/W	4717	A5540.01/230/WW	4554
242	36W	A5540.01/240/W	4922	A5540.01/240/WW	4752
252	37,5W	A5540.01/250/W	5128	A5540.01/250/WW	4950
262	39W	A5540.01/260/W	5333	A5540.01/260/WW	5148
272	40,5W	A5540.01/270/W	5538	A5540.01/270/WW	5346
282	42W	A5540.01/280/W	5743	A5540.01/280/WW	5544
292	43,5W	A5540.01/290/W	5948	A5540.01/290/WW	5742
302	45W	A5540.01/300/W	6153	A5540.01/300/WW	5940

* Articolo standard a catalogo
* Standard catalogue item

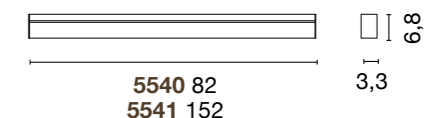

Sistema d'illuminazione lineare con sorgente LED per installazione a parete, soffitto e sospensione. Corpo in estruso d'alluminio verniciato bianco, dimensionato per poter contenere gli alimentatori.
Diffusore in policarbonato opalino.

Linear lighting system fitted with LED technology, for wall, ceiling and suspended use. White painted extruded aluminum profile sized to integrate power supplies.
Diffuser in opal polycarbonate.

Système d'éclairage linéaire équipé de technologie LED pour installation à mur, plafond et suspension. Profilé d'aluminium extrudé vernie blanc, dimensionné pour pouvoir contenir les convertisseurs.
Diffuseur en polycarbonate opalin.

Lineares Beleuchtungssystem mit LED-Modulen, für Wand-/Deckenmontage oder Aufhängung. Weiß lackiertes Aluminiumprofil mit integriertem Konverter. Diffusor aus opalen Polykarbonat.

Sistema de iluminación lineal a pared, techo y suspensión equipado con tecnología LED. Perfil en extrusión de aluminio pintado blanco dimensionado para contener los convertidores. Difusor de policarbonato opalino.

Линейная светодиодная система для установки на стену, потолок или с подвесом. Окрашенный в белый цвет экструзионный алюминиевый профиль со встроенным конвертером.

5540

1,1 kg

/W Led 12W 1641lm 4000K

/WW Led 12W 1584lm 3000K

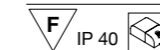

.01/W .01/WW

5541

1,5 kg

/W Led 22,5W 3076lm 4000K

/WW Led 22,5W 2970lm 3000K



.01/W .01/WW



Sistema d'illuminazione lineare con sorgente LED per installazione a parete, soffitto e sospensione. Corpo in estruso d'alluminio verniciato bianco, dimensionato per poter contenere gli alimentatori. Diffusore in policarbonato opalino. Partendo da singoli segmenti luminosi è possibile creare innumerevoli composizioni modulari grazie alla disponibilità di snodi e giunti studiati per ogni possibile necessità.

Linear lighting system fitted with LED technology, for wall, ceiling and suspended use. White painted extruded aluminum profile sized to integrate power supplies. Diffuser in opal polycarbonate. Starting from individual lighted segments you can create countless modular compositions thanks to the availability of a number of joints for any kind of installation.

Système d'éclairage linéaire équipé de technologie LED pour installation à mur, plafond et suspension. Profilé d'aluminium extrudé vernie blanc, dimensionné pour pouvoir contenir les convertisseurs. Diffuseur en polycarbonate opalin. Partent de simples segments lumineux, c'est possible de créer d'innombrables compositions modulaires grâce à la disponibilité de différents joints pour chaque type d'installation.

Lineares Beleuchtungssystem mit LED-Modulen, für Wand-/Deckenmontage oder Aufhängung. Weiß lackiertes Aluminiumprofil mit integrierbarem Konverter. Diffusor aus opalen Polycarbonat. Die einzelnen Lichtsegmente können mit verschiedenen Verbindern modular zu beliebigen Formen zusammengefügt und montiert werden.

Sistema de iluminación lineal a pared, techo y suspensión equipado con tecnología LED. Perfil en extrusión de aluminio pintado blanco dimensionado para contener los convertidores. Difusor de policarbonato opalino. Partiendo desde segmentos luminosos individuales se pueden crear innumerables composiciones modulares gracias a la disponibilidad de articulaciones diseñadas para cualquier tipo de instalación.

Линейная светодиодная система для установки на стену, потолок или с подвесом. Окрашенный в белый цвет экструзионный алюминиевый профиль со встроенным конвертером. Диффузор из матового поликарбонат. Из отдельных сегментов можно создавать бесконечные модульные композиции благодаря имеющимся многочисленным соединительным элементам.

SU MISURA - CUSTOM SIZE

Tabella lunghezze disponibili a richiesta.
Table of available lengths on request.

cm.	watt	white 4000K (W)	lm	warm white 3000K (WW)	lm
61,5	9W	A5542.01/60/W	1230	A5542.01/60/WW	1188
71,5	10,5W	A5542.01/70/W	1436	A5542.01/70/WW	1386
81,5	12W	5542.01/W *	1641	5542.01/WW *	1584
91,5	13,5W	A5542.01/90/W	1846	A5542.01/90/WW	1782
101,5	15W	A5542.01/100/W	2051	A5542.01/100/WW	1980
111,5	16,5W	A5542.01/110/W	2256	A5542.01/110/WW	2178
121,5	18W	A5542.01/120/W	2461	A5542.01/120/WW	2376
131,5	19,5W	A5542.01/130/W	2666	A5542.01/130/WW	2574
141,5	21W	A5542.01/140/W	2871	A5542.01/140/WW	2772
151,5	22,5W	5543.01/W *	3076	5543.01/WW *	2970
161,5	24W	A5542.01/160/W	3282	A5542.01/160/WW	3168
171,5	25,5W	A5542.01/170/W	3487	A5542.01/170/WW	3366
181,5	27W	A5542.01/180/W	3692	A5542.01/180/WW	3564
191,5	28,5W	A5542.01/190/W	3897	A5542.01/190/WW	3762
201,5	30W	A5542.01/200/W	4102	A5542.01/200/WW	3960
211,5	31,5W	A5542.01/210/W	4307	A5542.01/210/WW	4158
221,5	33W	A5542.01/220/W	4512	A5542.01/220/WW	4356
231,5	34,5W	A5542.01/230/W	4717	A5542.01/230/WW	4554
241,5	36W	A5542.01/240/W	4922	A5542.01/240/WW	4752
251,5	37,5W	A5542.01/250/W	5128	A5542.01/250/WW	4950
261,5	39W	A5542.01/260/W	5333	A5542.01/260/WW	5148
271,5	40,5W	A5542.01/270/W	5538	A5542.01/270/WW	5346
281,5	42W	A5542.01/280/W	5743	A5542.01/280/WW	5544
291,5	43,5W	A5542.01/290/W	5948	A5542.01/290/WW	5742
301,5	45W	A5542.01/300/W	6153	A5542.01/300/WW	5940

* Articolo standard a catalogo
* Standard catalogue item

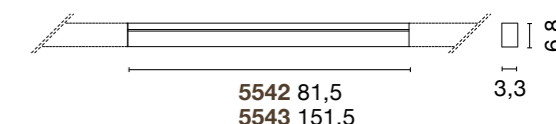



5542	1,1 kg	5543	1,5 kg
/W Led 12W 1641lm 4000K		/W Led 22,5W 3076lm 4000K	
/WW Led 12W 1584lm 3000K		/WW Led 22,5W 2970lm 3000K	
IP 40		IP 40	
.01/W .01/WW		.01/W .01/WW	

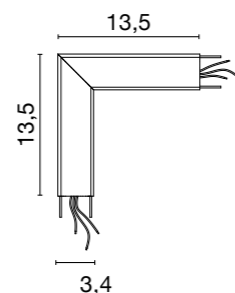

Angolo 90°
90° Corner





0941 0,4 kg
 /W Led 3W 410lm 4000K
 /WW Led 3W 396lm 3000K
 
 .01/W .01/WW

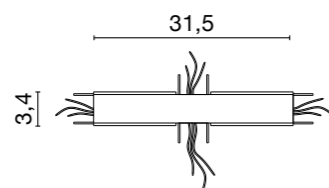

Giunzione a croce
Cross joint





0943 0,35 kg
 /W Led 4,5W 615lm 4000K
 /WW Led 4,5W 594lm 3000K
 
 .01/W .01/WW

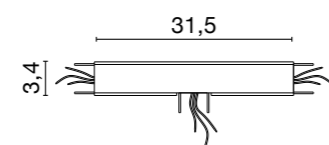

Giunzione a T
T joint



0942 0,35kg
 /W Led 4,5W 615lm 4000K
 /WW Led 4,5W 594lm 3000K
 
 .01/W .01/WW



Raccordo parete - plafone
Wall/Ceiling joint

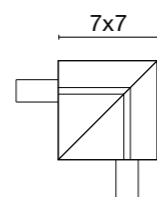

0944 0,15 kg
 .01



Diffusore in policarbonato
Polycarbonate diffuser

0948/200
Diffusore-Diffuser 200cm

0948/300
Diffusore-Diffuser 300cm



2 testate di chiusura.
2 closing heads.

0945
.01

Lampade a sospensione e a soffitto/parete in alluminio verniciato bianco e diffusore in metacrilato satinato termoformato. Accessorio di fissaggio in alluminio per installazione angolata e rotazione delle versioni parete/soffitto, art. 0172.01

Pendant and ceiling/wall lamps in white finished aluminum with satin thermoformed methacrylate diffuser. Accessory aluminum bracket allowing angled fixing and rotation for ceiling/wall versions, art. 0172.01

Suspension et plafonnier/applique en aluminium verni blanc avec écran diffuseur en méthacrylate satiné thermoformé. Accessoire pivot en aluminium pour fixation angulée et rotation des appareils applique/plafonnier, art. 0172.01

Pendel- sowie Wand- und Deckenleuchten aus Weiß lackiertem Aluminium. Diffusor aus satiniertem Acrylglas. Befestigungszubehör für drehbare und abgewinkelte Montage der Wand-/Deckenleuchte, Art. 0172.01.

Lampara de techo/pared y colgante de aluminio pintado blanco, difusor de metacrilato satinado. Accesorio de anclaje en aluminio para instalación angular y rotación del modelo techo/pared, art. 0172.01

Подвесной и потолочный/настенный светильники, корпус из алюминия, окрашенного в белый цвет, рассеиватель из термоформированного матового метакрилата. Как аксессуар алюминиевый поворотный кронштейн для потолочной/настенной модели, арт. 0172.01



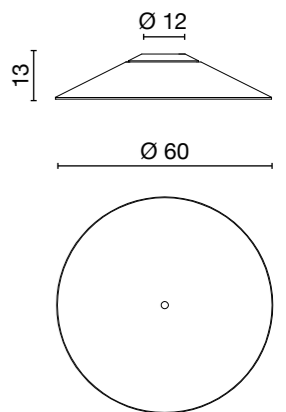
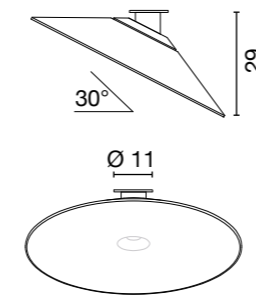

Optional:
Accessorio di fissaggio in alluminio per installazione angolata e rotazione delle versioni parete/soffitto, art. 0172.01

Accessory aluminum bracket allowing angled fixing and rotation of ceiling/wall versions, art. 0172.01

Accessoire pivot en aluminium pour fixation angulée et rotation des appareils applique/plafonnier, art. 0172.01

Befestigungszubehör für drehbare und abgewinkelte Montage der Wand-/Deckenleuchte, art. 0172.01

Accesorio de anclaje en aluminio para instalación angular y rotación del modelo techo/pared, art. 0172.01

Аксессуар: алюминиевый поворотный кронштейн для потолочной версии, art. 0172.01

5227 led 3,9 kg

Led 32,6W 3950 lm 3000K

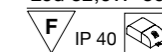

.01

5228 fluo 3,8 kg

55W 2GX13

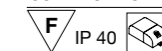

.01



Proiettore orientabile da soffitto o parete, corpo in alluminio verniciato bianco-nero.
Disponibile sia con tecnologia power LED che COB LED.

Ceiling or wall adjustable spotlight. Frame in painted aluminum in black-and-white finish.
Available both with power LED and COB LED technology.

Projecteur orientable pour plafond ou mur. Structure en aluminium verni blanc-noir.
Disponible soit en version power LED soit en COB LED

Verstellbare Lichtstrahler für Decken- oder Wandbefestigung. Gestell aus Weiß-Schwarz lackiertem Aluminium. Verfügbar in power LED sowie in COB LED Ausführungen.

Proyector orientable para techo y pared. Cuerpo de aluminio pintado en blanco-negro. Disponible en version power LED y tambien en COB LED

Потолочный или настенный прожектор. Корпус из алюминия, окрашенного в белый и черный цвет. Имеются 2 варианта исполнения с мощными светодиодами или на плате.

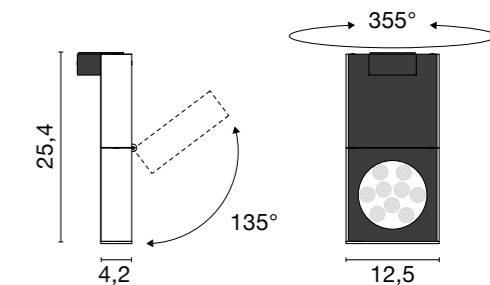

4526
Led 16W 980lm 3000K

1,5 kg



.01

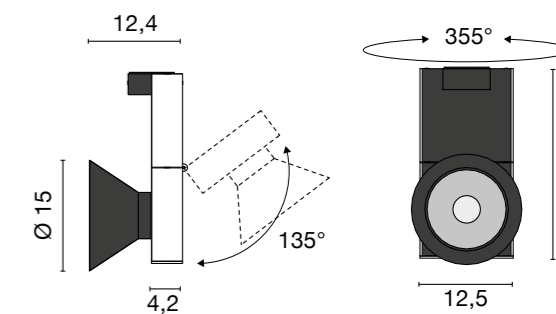

4527.01.18
Led 19W 2470 lm 3000K

1,7 kg

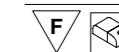



4527.01.41
Led 19W 2470 lm 3000K

1,7 kg

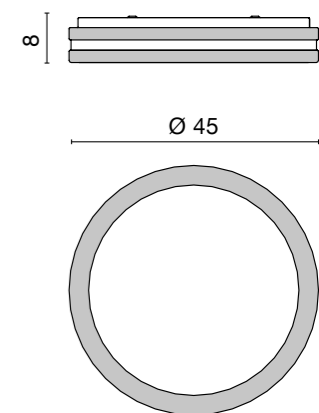



5215 3,3 kg
 3x18W 2G11
 F IP 40 

5216 em 4,1 kg
 3x18W 2G11
 F IP 40 

Lampada da parete/soffitto. Cornice in metallo verniciato grigio e schermo in metacrilato satinato.

Applique/plafonnier ronde ou carré. Cadre en métal verni gris et diffuseur en méthacrylate satiné.

Lampara de techo/pared. Marco de metal pintado gris y difusor de metacrilato satinado.

Потолочный или настенный светильник. Корпус из окрашенного металла, диффузор из матового метакрилата

Ceiling/wall lamp. Metal trim painted in grey and satin methacrylate diffuser.

Decken- /Wandleuchte. Metallrahme grau lackiert und Diffusor aus satiniertem Metacrylat.

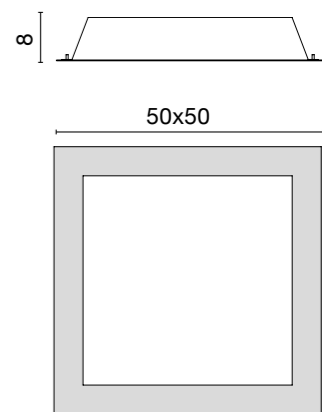

5156 4,4 kg
 3x24W 2G11
 F IP 40

5157 em 5,1 kg
 3x24W 2G11
 F IP 40

Lampada da parete/soffitto. Cornice in metallo verniciato bianco o grigio e schermo in metacrilato satinato.

Ceiling/wall lamp. Metal trim painted in white or grey and satin methacrylate diffuser.

Applique/plafonnier. Cadre en métal verni blanc ou gris et diffuseur en méthacrylate satiné.

Decken- /Wandleuchte. Metallrahme weiß oder grau lackiert und Diffusor aus satiniertem Metacrylat.

Lampara de techo/pared. Marco de metal pintado blanco o gris y difusor de metacrilato satinado.

Потолочный или настенный светильник. Корпус из окрашенного металла, диффузор из матового метакрилата

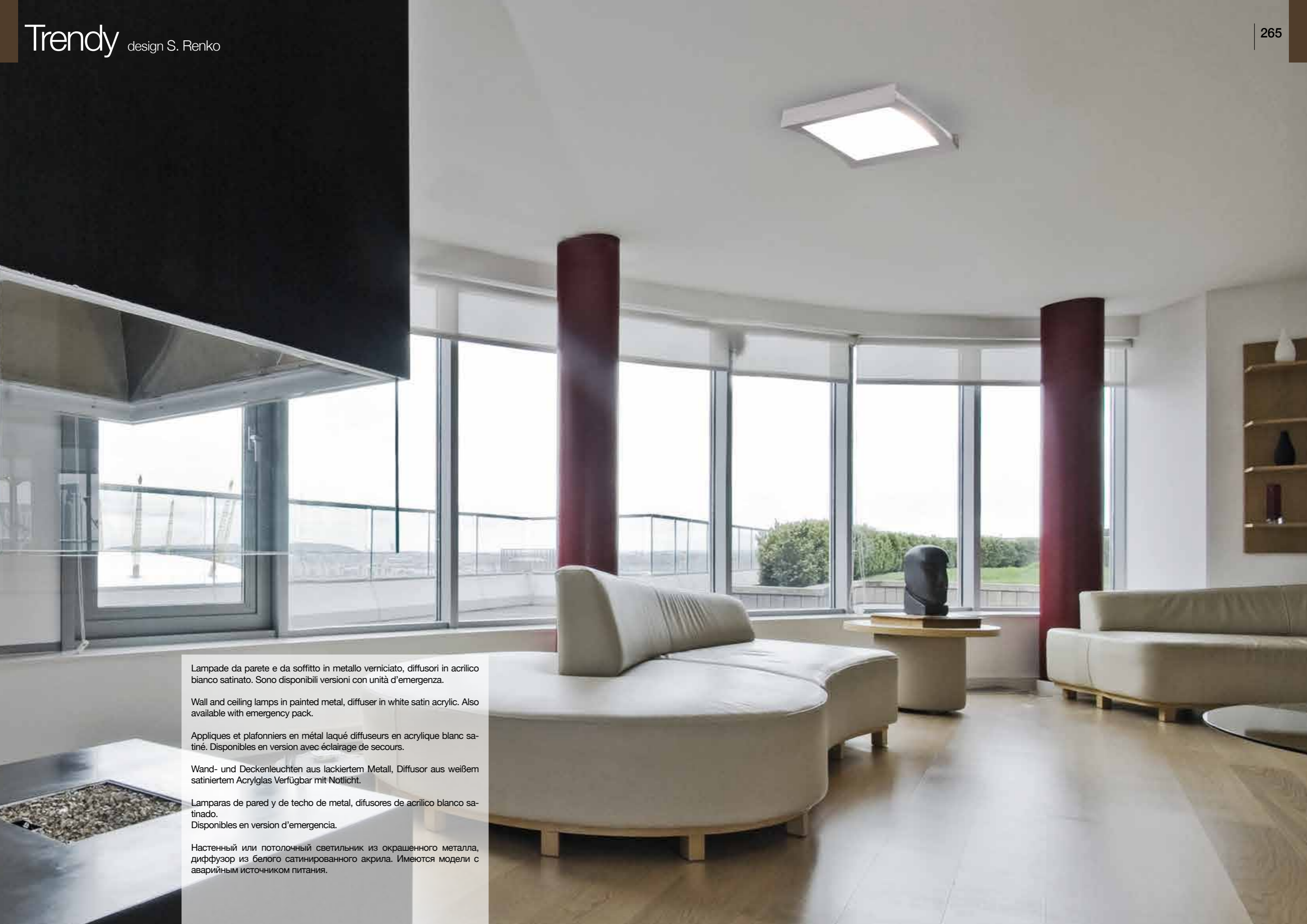

Lampade da parete e da soffitto in metallo verniciato, diffusori in acrilico bianco satinato. Sono disponibili versioni con unità d'emergenza.

Wall and ceiling lamps in painted metal, diffuser in white satin acrylic. Also available with emergency pack.

Appliques et plafonniers en métal laqué diffuseurs en acrylique blanc satiné. Disponibles en version avec éclairage de secours.

Wand- und Deckenleuchten aus lackiertem Metall, Diffusor aus weißem satiniertem Acrylglas Verfügbar mit Notlicht.

Lamparas de pared y de techo de metal, difusores de acrilico blanco satinado. Disponibles en version d'emergencia.

Настенный или потолочный светильник из окрашенного металла, диффузор из белого сатирированного акрила. Имеются модели с аварийным источником питания.

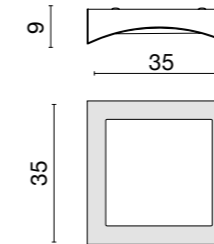

5160 fluo 3,3 kg
2x18W 2G11
F IP 40
.40

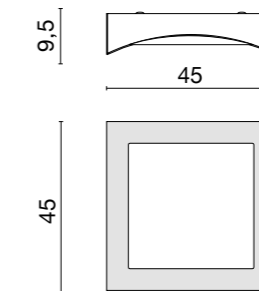

5165 5,2 kg
3x24W 2G11
F IP 40
.40

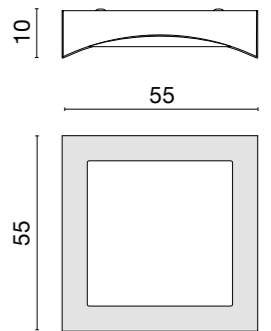

5170 8,4 kg
4x36W 2G11
F IP 40 EL
.40

5162 em 4 kg
2x18W 2G11
F IP 40
.40

5167 em 5,9 kg
3x24W 2G11
F IP 40
.40

5172 em 10 kg
4x36W 2G11
F IP 40 EL
.40

5238 led 5,2 kg
/W Led 32,6W 4310lm 4000K
/WW Led 32,6W 3950lm 3000K
F
.40/W .40/WW

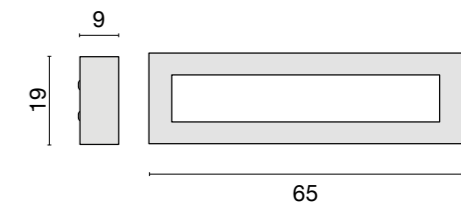

4300 fluo 3,7 kg
 2x24W G5 T5
 F IP 40

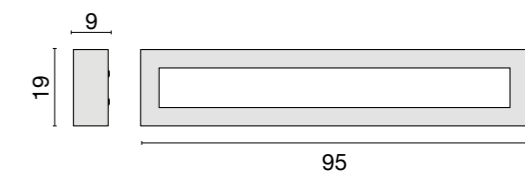

4303 fluo 5 kg
 2x39W G5 T5
 F IP 40

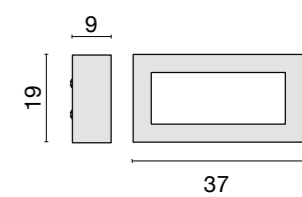

4305 fluo 2 kg
 24W 2G11
 F IP 40

Lampade da parete e da soffitto in metallo verniciato, diffusori in acrilico bianco satinato.

Appliques et plafonniers en métal laqué, diffuseurs en acrylique blanc satiné.

Lamparas de pared y de techo de metal pintado, difusores de acrilico blanco satinado.

Wall and ceiling lamps in bright, diffusers in white satin acrylic.

Wand- und Deckenleuchten aus lackiertem Metall, Diffusor aus weißem satiniertem Acrylglas.

Настенный или потолочный светильник из окрашенного металла, диффузор из белого сатирированного акрила.



Lampade da parete/plafone in vetro curvato, satinato e verniciato bianco.
Particolari in metallo cromato.
Disponibile anche con unità d'emergenza.

Wall or ceiling lamps in curved satin glass, painted white. Details in chromed metal. Also available also with emergency unit.

Appliques/plafonniers en verre incurvé satiné, verni blanc. Détails en métal chromé. Livrable aussi avec unité d'urgence.

Wand-/Deckenleuchten. Diffusor aus gebogenem satinglas lackiert, wei.
Verchromte Metallteile. Auch verfügbar mit integriertem Notbeleuchtung.

Lamparas de pared y de techo de cristal curvado, pintado blanco.
Detalles cromados. Disponibles en version d'emergencia.

Настенный или потолочный светильник из гнутого матового белого стекла. Детали из хромированного металла. Имеется модель с встроенным модулем аварийного питания.

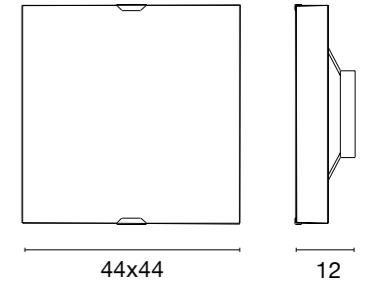

5096 2,6 kg
 160W R7s ECO
 F
 .57

5396 fluo 3,5 kg
 2x32W GX24 q.3
 F
 .57

5296 em 4,6 kg
 2x32W GX24 q.3
 F
 .57

5596 led 3,3 kg
 led 2x13W 2020lm 3000K
 F
 .57/WW

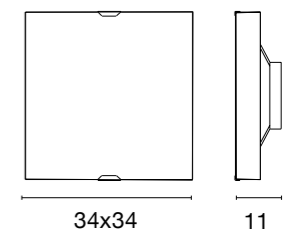
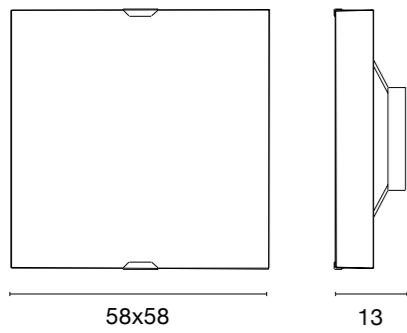

5095 2 kg
 120W R7s ECO
 F
 .57

5395 fluo 2,4 kg
 2x26W G24 q.3
 F
 .57

5295 em 3,6 kg
 2x26W G24 q.3
 F
 .57

5098 5,9 kg
 2x160W R7s ECO
 F
 .57

5198 fluo 5,1 kg
 2x42W GX24 q.4
 F
 .57

5298 em 6,3 kg
 2x42W GX24 q.4
 F
 .57



Lampade da parete/plafone in vetro curvato bianco satinato. Particolari in metallo cromato.

Ceiling-/wall lamps in white curved satin glass. Details in chromed metal.

Appliques ou plafonniers en verre incurvé blanc satiné. Détails en métal chromé.

Wand- oder Deckenleuchten aus weißem gebogenem Satinglas. Verchromte Metallteile.

Appliques o lamparas de techo de cristal curvado blanco satinado. Detalles en metal cromado.

Настенный или потолочный светильник из белого гнутого матового стекла. Детали из хромированного металла.

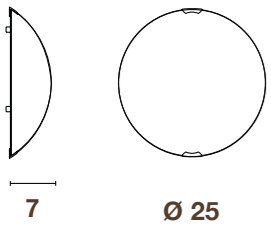

5008 1 kg
48W R7s (78 mm.) ECO
F
.31

5525 led 1,50 kg
Led 10W 1200lm 3000K
F
.31/WW

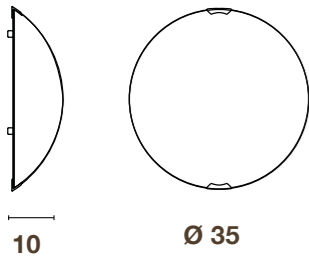

5009 1,6 kg
80W R7s (78 mm.) ECO
.31

5209 fluo 1,6 kg
22W 2GX13
F
.31

5526 led 2,50 kg
Led 10W 1200lm 3000K
F
.31/WW

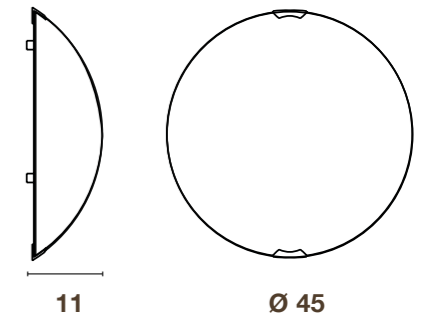

5010 2,6 kg
120W R7s ECO
.31

5210 fluo 3,8 kg
40W 2GX13
F
.31

5527 led 3 kg
Led 20,4W 2300lm 3000K
F
.31/WW

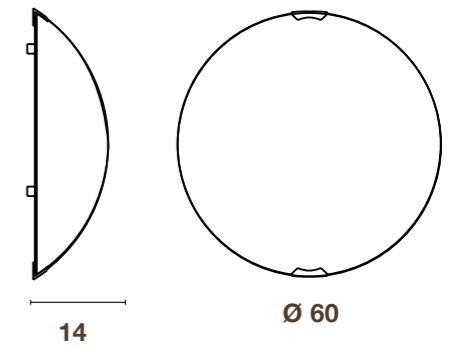

5011 4,2 kg
230W R7s ECO
.31

5211 fluo 4,1 kg
55W 2GX13
F
.31

5528 led 4 kg
Led 20,4W 2300lm 3000K
F
.31/WW



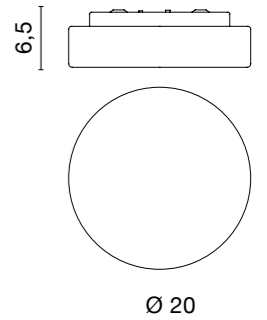

5218 halo 0,7 kg
 48W G9 ECO
 IP 40
 .57

5518 led 0,7 kg
 Led 8W 670lm 3000K
 IP 40
 .57/WW

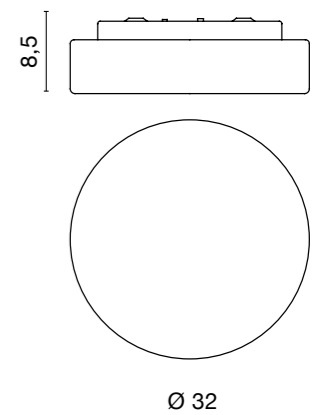

5219 halo 2,1 kg
 80W R7s (78 mm.) ECO
 IP 40
 .57

5220 fluo 2,1 kg
 2x18W G24 q.2
 IP 40
 .57

5519 led 2 kg
 Led 10W 1200lm 3000K
 IP 40
 .57/WW

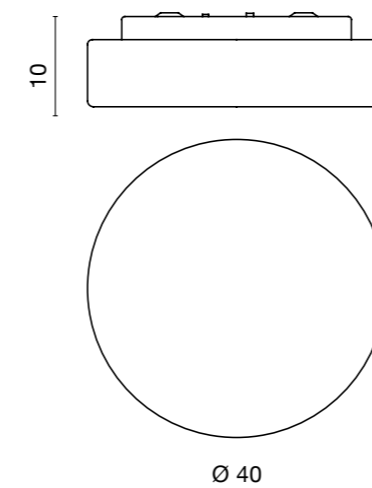

5234 3 kg
 2x42W E27 ECO
 2x21W E27 Fluo EL
 2x10W E27 Led (cod. 0105)
 IP 40
 .57

5235 led 2,80 kg
 Led 15,3W 2180lm 3000K
 IP 40
 .57/WW

Lamparas de techo/apliques con difusor de vidrio soplado satinado blanco.
 Cuerpo de metal pintado blanco.

Потолочный или настенный светильник.
 Корпус из окрашенного в белый цвет металла,
 Диффузор из белого дутого матового стекла.

Lampe à plafond/mur avec structure en métal verni blanc et diffuseur en verre soufflé blanc satiné.

Wand-/Deckenleuchte, Struktur aus weiß lackiertem Metall und Diffusor aus weißem Geblasenem satiniertem Glas.

Lampada da plafone/parete con struttura in metallo verniciato bianco e diffusore in vetro soffiato bianco satinato.

Ceiling/wall lamp, body in white painted metal and diffusor in white satin blown glass.

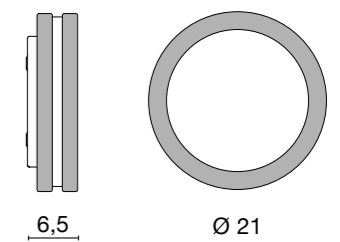

5212 1 kg
 48W G9 ECO
 IP 40
 .31 .40

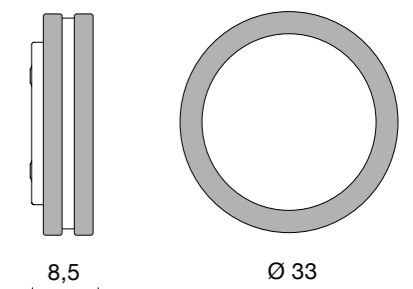

5213 halo 2,8 kg
 80W R7s (78 mm.) ECO
 IP 40 F
 .31 .40

5214 fluo 2,9 kg
 2x18W G24 q.2
 IP 40 F
 .31 .40

Lampada da parete/soffitto in vetro soffiato bianco satinato, anello in metallo verniciato grigio o cromato.

Applique/plafonnier en verre soufflé satiné blanc anneau en métal chromé ou verni gris.

Lampara de pared/techo de vidrio soplado blanco satinado y anillo en metal cromado o pintado gris.

Ceiling-wall lamp in grey painted or chromed metal . White blown matt glass diffuser.

Wand-/Deckenleuchte aus weißem geblasenem satiniertem Glas; Metallring verchromt oder grau lackiert.

Настенный или потолочный светильник из окрашенного или хромированного металла. Белый плафон из матового стекла.

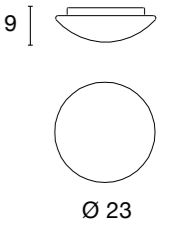

5150	0,9 kg
28W E27 ECO	
10W E27 Led (cod. 0105)	
F IP 40	
.57	

5521 led	1,00 kg
Led 10W 1200lm 3000K	
F IP 40	
.57/WW	

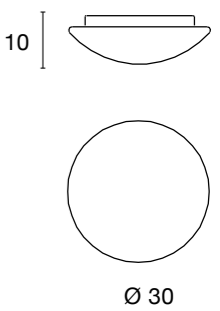

5132	1,3 kg
52W E27 ECO	
21W E27 Fluo EL	
10W E27 Led (cod. 0105)	
F IP 40	
.57	

5522 led	1,4 kg
Led 10W 1200lm 3000K	
F IP 40	
.57/WW	

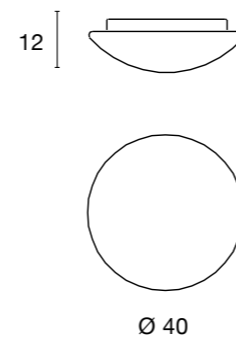

5134	2,3 kg
2x42W E27 ECO	
2x21W E27 Fluo EL	
2x10W E27 Led (cod. 0105)	
IP 40	
.57	

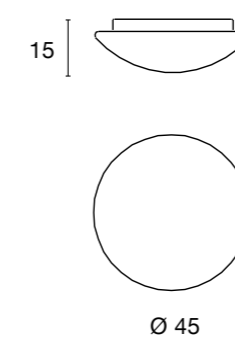

5139	3,2 kg
2x52W E27 ECO	
2x24W E27 Fluo EL	
2x10W E27 Led (cod. 0105)	
IP 40	
.57	

Lampade da soffitto o parete in vetro soffiato bianco satinato.

Plafonniers ou appliques en verre soufflé satiné blanc.

Lamparas de techo o apliques de cristal soplado satinado blanco.

Ceiling or wall lamps in white satin blown glass.

Decken- oder Wandleuchten aus weißem mundgeblasenes Satinglas.

Потолочный, или настенный светильник из дутого белого матового стекла.

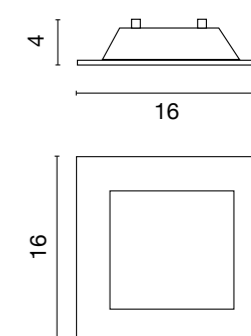

5151 0,6 kg
48W G9 ECO

.01 .03 .31 .32

5533 led 0,50 kg

Led 8W 670lm 3000K



.01/WW .03/WW .31/WW .32/WW

Lampade da parete/soffitto con cornice in metallo verniciata, cromata o nichelata.
Diffusore in vetro bianco satinato.

Ceiling/wall lamps with metal frame in painted finish, or plated in chrome or nickel matt.
White satin glass diffuser.

Appliques/plafonniers avec cadre en métal nickelé, chromé ou verni.
Verre diffuseur opale blanc.

Wand-/Deckenleuchten mit Metallrahme. Ausführung: Nickel matt, verchromt oder lackiert.
Diffusor aus weißem satiniertem Glas.

Lamparas de pared/techo marco de metal pintado, cromado o nichelado.
Difusor de vidrio blanco satinado.

Настенный и потолочный светильник из окрашенного, хромированного или никелированного металла. Диффузор из белого матового стекла.

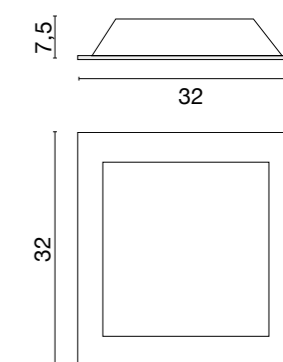

5154 halo 2 kg

120W R7s ECO 



.01 .03 .31 .32

5155 fluo 2,1 kg

2x18W G24 q.2 



.01 .03 .31 .32

5159 led 2,3 kg

/W Led 17,3W 2330lm 4000K

/WW Led 17,3W 2200lm 3000K



.01/W .01/WW .03/W .03/WW
.31/W .31/WW .32/W .32/WW

Lampade da parete/soffitto con cornice in metallo verniciata, cromata o nichelata.
Diffusore in vetro bianco satinato.

Ceiling/wall lamps with metal frame in painted finish, or plated in chrome or nickel matt.
White satin glass diffuser.

Appliques/plafonniers avec cadre en métal nickelé, chromé ou verni.
Verre diffuseur opale blanc.

Wand-/Deckenleuchten mit Metallrahme. Ausführung: Nickel matt, verchromt oder lackiert.
Diffusor aus weißem satiniertem Glas.

Lamparas de pared/techo marco de metal pintado, cromado o nichelado.
Difusor de vidrio blanco satinado.

Настенный и потолочный светильник из окрашенного, хромированного или никелированного металла. Диффузор из белого матового стекла.

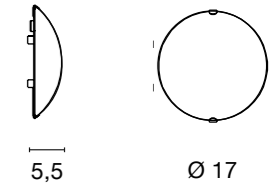

5013 Minipin 0,6 kg
 48W G9 ECO
 F
 .31

5530 Minipin led 0,50 kg
 Led 8W 670lm 3000K
 F
 .32/WW

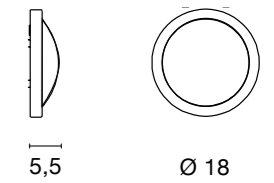

5141 Tondapin 0,8 kg
 48W G9 ECO
 F
 .32

5531 Tondapin led 0,50 kg
 Led 8W 670lm 3000K
 F
 .32/WW

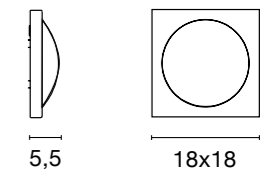

5142 Quadrapin 0,9 kg
 48W G9 ECO
 F
 .32

5532 Quadrapin led 0,50 kg
 Led 8W 670lm 3000K
 F
 .32/WW

Lampade da soffitto o parete in vetro pressato bianco satinato. Cornice in metallo nichelato satinato.

Wall or ceiling lamps in white pressed mattglass. Frame in nickel matt metal.

Appliques ou plafonniers en verre pressé, satiné blanc. Cornis en métal nickel satiné.

Wand- oder Deckenleuchten aus weissem Mattglas. Rahmen aus Metall in nickelmatt.

Appliques o lamparas de techo de cristal prensado blanco satinado. Marco de acero satinado.

Настенный или потолочный светильник из белого прессованного матового стекла. Детали из матового никелированного металла.



Lampada da soffitto e parete a luce diffusa con struttura in metallo verniciato bianco. Corpo in metacrilato trasparente blu, arancio, bianco anice o fumé e diffusore in metacrilato satinato.

Lampe à plafond et mur avec structure en métal verni blanc. Corps en méthacrylate transparent en couleur bleu, orange, blanc anis ou fumé. Diffuseur en méthacrylate satiné.

Lampara de techo y pared con estructura de metal pintado blanco. Cuerpo de metacrilato transparente blau, naranja, anis blanco, gris. Difusor de metacrilato satinado.

Ceiling and wall lamp for diffused lighting, structure in white painted metal. Body in transparent methacrylate in blue, orange, anise white and smoke grey color, diffuser in satin methacrylate.

Wand- und Deckenleuchte, Struktur aus weiß lackiertem Metall. Körper aus transparentem farbigem Metacrylat in blau, orange, anisweiß oder rauchgrau. Diffusor aus satiniertem Metacrylat.

Потолочный или настенный светильник рассеянного света из окрашенного в белый цвет металла. Боковые стенки из прозрачного, синего, оранжевого или белого матового метакрилата. Диффузор сатирированный метакрилат.

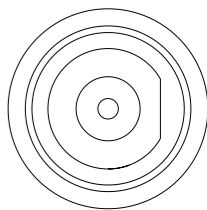
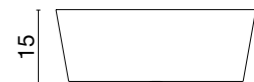

Ø 43

5221

2,9 kg

22W+40W 2GX13

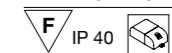

.01 .04 .07 .09

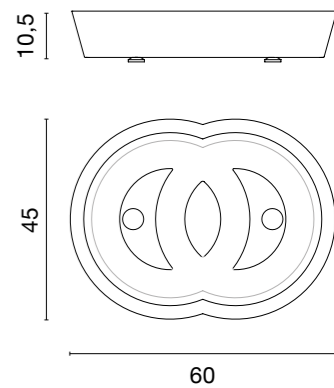

Lampada da parete/soffitto a luce diffusa con struttura in metallo verniciato bianco. Corpo in metacrilato trasparente blu, arancio, fumé. Diffusore in metacrilato satinato.

Lampe à mur/plafond avec structure en métal verni blanc. Corps en méthacrylate transparent en couleur bleu, orange, ou fumé, Diffuseur en méthacrylate satiné.

Lampara de techo y pared con estructura de metal pintado. Cuerpo de metacrilato transparente azul, naranja, gris. Difusor de metacrilato satinado.

Ceiling/wall lamp for diffused lighting, structure in white painted metal. Body in transparent methacrylate in blue, orange and smoke grey color, diffuser in satin methacrylate.

Wand-/Deckenleuchte, Struktur aus weiß lackiertem Metall. Körper aus transparentem farbigem Metacrylat in blau, orange, oder rauchgrau. Diffusor aus satiniertem Metacrylat.

Потолочный или настенный светильник рассеянного света. Структура из окрашенного в белый цвет металла, корпус из прозрачного метакрилата, синего, или дымчатого серого цвета. Диффузор из сатинированного метакрилата.

5222 4,1 kg
 2x40W 2GX13
 F IP 40
 .04 .07 .09

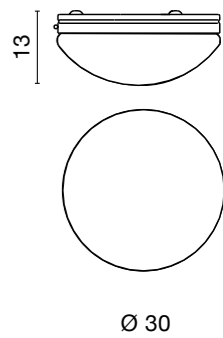

Lampade da plafone o parete in vetro opale soffiato. Montatura in ottone lucido o cromato.

Plafonniers ou appliques en verre opale soufflé. Structure en finition laiton poli ou chromé.

Appliques o lamparas de techo de cristal opal blanco soblado. Cuerpo de laton pulido o cromado.

Ceiling or wall lamps in white, blown opal glass. Frame in polished brass or chromed finish.

Decken oder Wandleuchten aus geblasenem Opalglas. Gestell aus Messing poliert oder verchromt.

Потолочный или настенный светильник из дутого опалового стекла. Детали из латуни: хромированной или полированной.

5017	1,4 kg
2x42W E27 ECO	
2x21W E27 Fluo EL	
2x10W E27 Led (cod. 0105)	
F	
.20 .22	

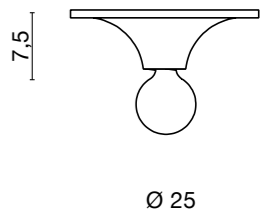

5038 0,5 kg
 18W E27 Fluo EL Globe
 F □
 .01

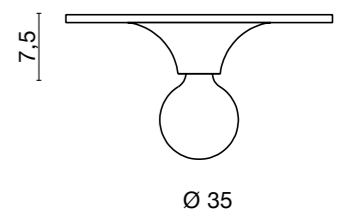

5039 0,7 kg
 18W E27 Fluo EL Globe
 F □
 .01

Plafoniere in alluminio verniciato bianco.
 Aluminium ceiling lamps, white finish.

Plafonniers en aluminium verni blanc.
 Deckenleuchten in weiß lackiertem Aluminium.

Lamparas de techo de aluminio pintado de blanco
 Потолочный светильник из окрашенного в белый цвет алюминия

Soffitto - Ceiling



Alea 312



Alea Maxi 320



Fokus 316



Fokus Maxi 322



Matassa 306



Megavide 300



Miniteda 324



Phantom 308



Phantom Maxi 310



Prêt à Porter 304



Teda 324



Trifoglio 302



Lampade a sospensione o soffitto di grandi dimensioni equipaggiate con sorgenti LED. Struttura ed elementi modulari del diffusore sono realizzati in alluminio verniciato. Le versioni a soffitto sono dotate di un disco bianco riverniciabile per nascondere l'alimentatore e simulare l'effetto di un apparecchio a scomparsa. Alimentatore a bordo.

Large Suspensions or ceiling lamps fitted with LED light engine . Structure and modular elements of the shade are realized in painted aluminum. Ceiling version includes a white re-paintable panel to hide converter and simulate the effect of a recessed fixture. Converter on board.

Suspensions ou lampes à plafond de grand dimensions équipé avec des sources LED. Structure et éléments modulaires du diffuseur sont réalisés en aluminium verni. Les versions à plafond incluent un panneau blanc à peindre qui cache le convertisseur et simule l'effet d'un luminaire encastré . Convertisseur à bord.

Großformatige Pendel- oder Deckenleuchten mit LED Technik. Struktur und modulare Elemente des Schirms aus lackiertem Aluminium. Die Deckenleuchten werden mit einem weißen, lackierbaren Paneel zur Abdeckung des Konverters geliefert (gleicher Effekt wie bei Einbau). Inklusive Konverter.

Lámparas colgantes o de techo de grande diámetro equipadas con fuente de luz LED. Estructura y elementos modulares de la sombra son realizados en aluminio pintado . Versión de techo incluye un panel blanco repintable para ocultar el convertidor y simular el efecto de un aparato empotrado. Convertidor incluido.

Большой подвесной или потолочный светильник на светодиодах. Структура и детали из окрашенного алюминия. Потолочные модели с окрашиваемой панелью, за которой прячется конвертер. Конвертер включен.

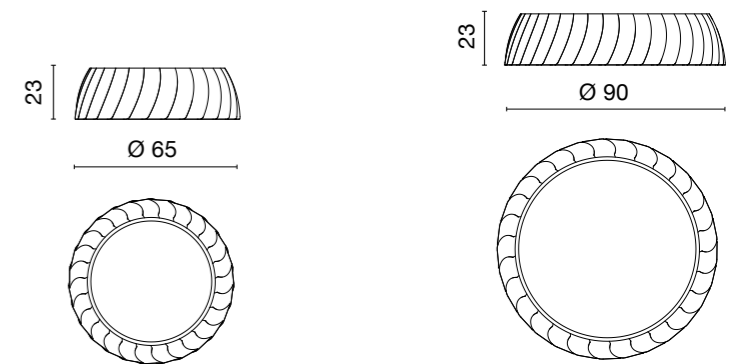

5536

3 kg

Led 22,5W 2895lm 3000K



.01/WW

5537

4 kg

Led 33W 4246lm 3000K

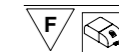

.01/WW

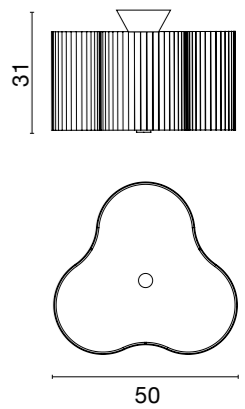

Collezione di lampade a paralume. con struttura in metallo verniciato bianco o nero. Le sospensioni e le plafoniere sono dotate di schermo diffusore in metacrilato satinato. Paralumi in tessuto ignifugo a pieghe bianco o nero.

Collection de lampes avec abat-jour avec structure en métal verni. Les suspensions et les plafonniers sont livrées avec diffuseur en méthacrylate satiné. Abat-jour en tissu ignifuge plissé blanc ou noir.

Lamparas con pantalla, estructura de metal pintado blanco o negro. La version colgante y de techo tiene una difusor de metacrilato satinado. Pantalla de tejido ignifugo blanco o negro.

Series of shaded lamps with painted metal structures white or black finish.. Suspensions and ceiling lamps are provided with satin methacrylate diffuser. Lampshades in plissé fireproof cloth white or black.

Kollektion von Schirmleuchten mit Gestell aus weiß oder schwarz lackiertem Metall. Hänge- und Deckenleuchten sind mit einem Diffusor aus satiniertem Metacrylat ausgestattet. Schirm aus feuerfestem Stoff plissé schwarz oder weiß.

Серия ламп с абажурами. Металлическая структура окрашена в белый или черный цвет. Подвесные светильники с рассеивателем из матового метакрилата и устройством децентрализации. Абажуры из негорючей плиссированной ткани черного и белого цвета.

5003	3,2 kg
70W E27 ECO	
24W E27 Fluo EL	
10W E27 Led (cod. 0105)	
F	
.01 .02	

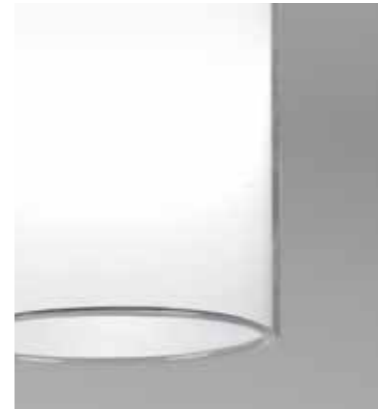
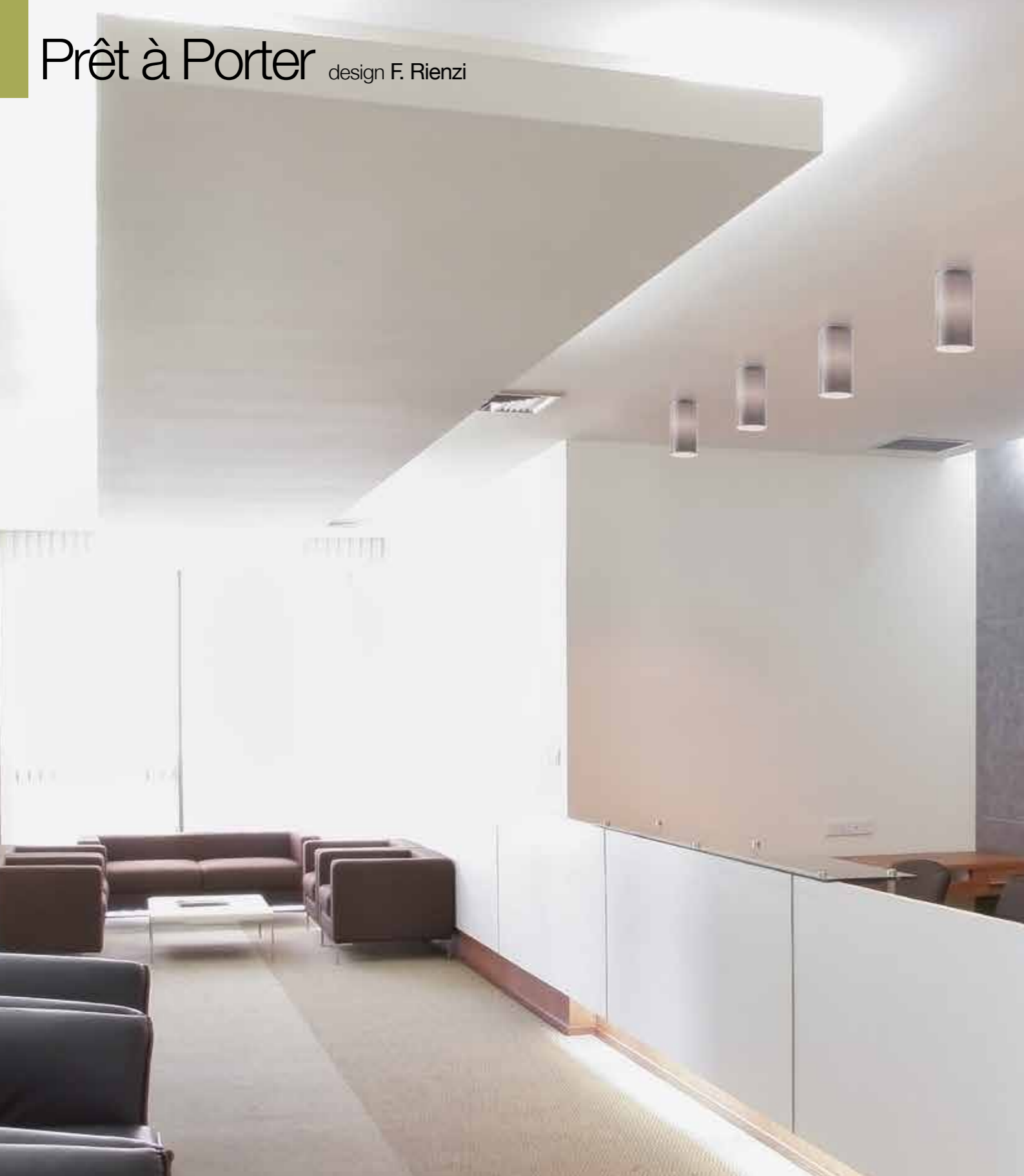

.01 Bianca
.01 White



.01 /A Optical 3D
.01 /A Optical 3D



.01 /B Rete bianca
.01 /B White net



.01 /E Raffia argento
.01 /E Silver raffia

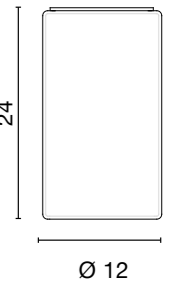

Lampade a sospensione e a soffitto in vetro Pyrex trasparente con inserto bianco incluso e una scelta di finiture. Sospensione con elemento di decentramento incluso.

Suspension and ceiling lamps in clear Pyrex glass with white insert included and a range of finishes. Suspension is including displacement component.

Suspensions et plafonniers en verre Pyrex transparent avec insert blanc inclus et un choix de finitions. La suspension est livrée avec élément de déplacement.

Pendent- und Deckenleuchten in transparentem Pyrexie Glas mit einem Weißem Einsatz inbegriffen und noch eine Palette verfügbar. Pendelleuchte mit Umlenkelement inbegriffen.

Colgantes y lamparas de techo de vidrio pyrex transparentes con inserte blanco incluido y gama de acabados. Lampara colgante con elemento para desplazar incluido.

Потолочные светильники из прочного боросиликатного стекла пирекс с белой вставкой. Поставляются с набором съемных декоративных аксессуаров, включая устройство для децентрализации.

5233

16W E27 Fluo EL

10W E27 Led (cod. 0105)



.01 .01/A .01/B .01/E

1 kg



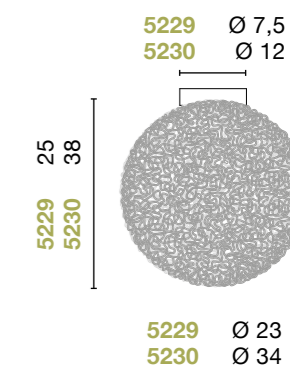
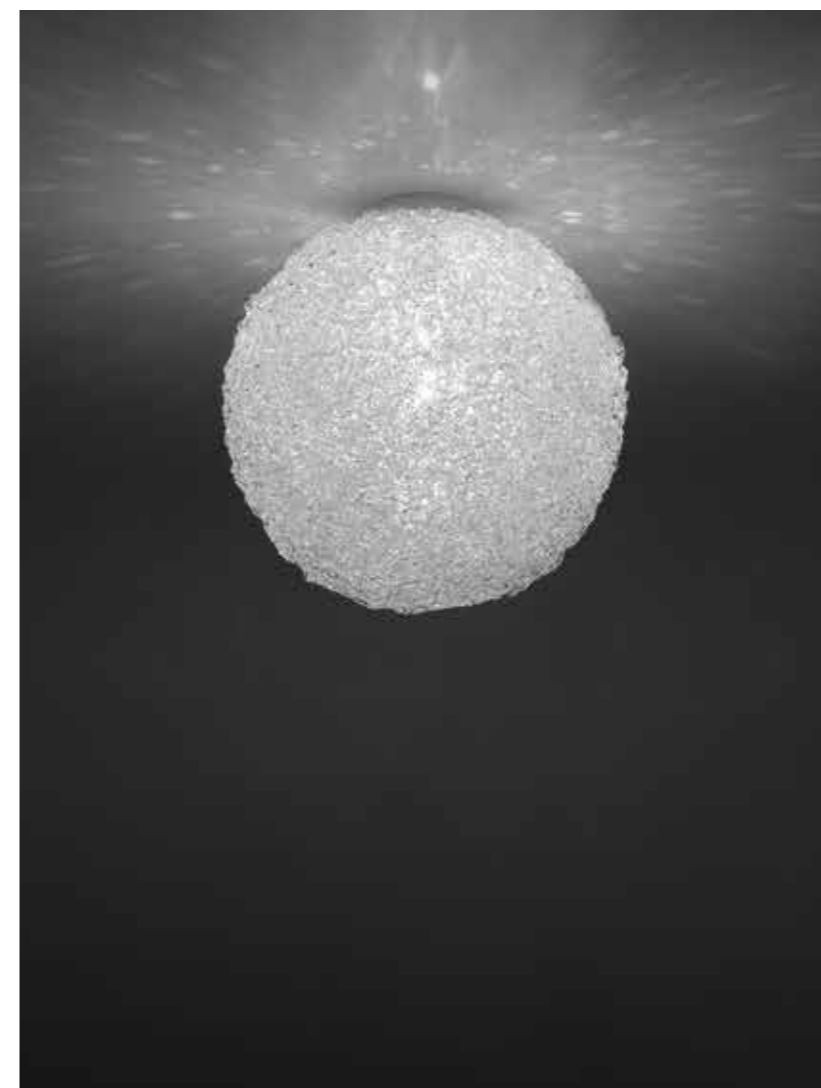

5229	2 kg
33W G9 ECO	
4W G9 Led	
.00	

5230	4,5 kg
42W E27 ECO	
16W E27 Fluo EL	
10W E27 Led (cod. 0105)	
.00	

Collezione di lampade in filo di metacrilato extra-chiaro colato con tecnologia Flight-Flow.

Collection de lampes en fil de méthacrylate extra-clair coulé selon la technologie Flight-Flow.

Colección de lamparas echas in hilo de metacrilato colado con tecnologia Flight-Flow.

Collection of lamps made of clear poured methacrylate yarn with Flight-Flow technology.

Kollektion Von Leuchten aus Draht aus extraklar Methacrylat verschmolzen mit Flight-Flow Technologie.

Коллекция светильников, изготовленных вручную из прозрачной метакрилатовой нити по технологии Flight-Flow.

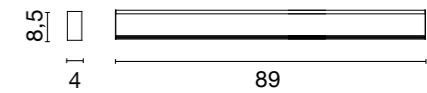
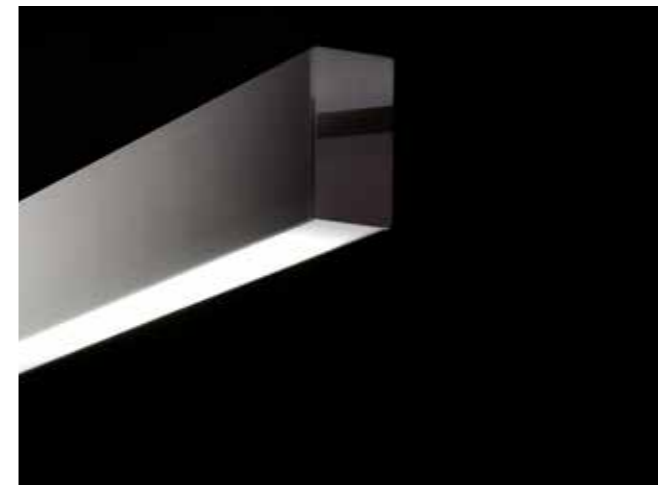

5223 1,9 kg

39W G5 T5



F IP 40

.01

5236 led 1,4 kg

/W Led 18,7W 2380lm 4000K

/WW Led 18,7W 2250lm 3000K

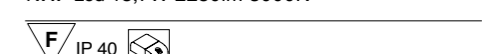

F IP 40

.01/W .01/WW

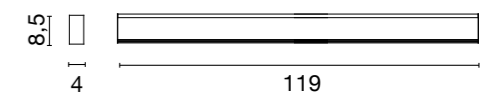

5224 2,5 kg

54W G5 T5

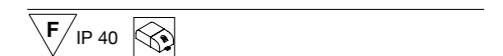

F IP 40

.01

5237 led 1,7 kg

/W Led 25W 3170lm 4000K

/WW Led 25W 3000lm 3000K

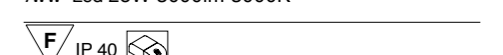

F IP 40

.01/W .01/WW

Lampade a soffitto, corpo in alluminio verniciato bianco, tappi in policarbonato cromato e schermo in metacrilato satinato.

Plafonniers, corps en aluminium, terminales en polycarbonate chromé et diffuseur en méthacrylate satiné.

Lamparas de techo, cuerpo de aluminio pintado blanco, terminales en policarbonato cromado y pantalla in metacrilato satinado.

Ceiling lamps. White painted aluminum body, sides in chromed polycarbonate and shade in satin methacrylate.

Deckenleuchte, körper aus Aluminium, Seitenteile aus verchromtem Polykarbonat und Diffusor aus satiniertem Methacrylat.

Потолочный светильник. Корпус из окрашенного алюминия, боковые детали из хромированного поликарбоната и абажур из сатирированного метакрилата. Имеются специальные диффузоры как опция.

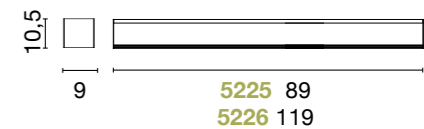
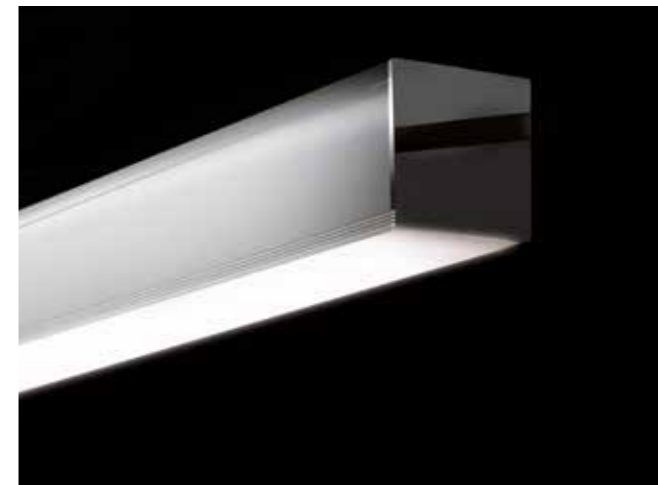

5225 2,8 kg
2x39W G5 T5
F IP 40

5226 3,9 kg
2x54W G5 T5
F IP 40



Optional:
Schermo ad alta efficienza
High efficiency diffuser
Art. 0870/90
Art. 0870/120

Lampade o a soffitto, corpo in alluminio verniciato bianco, tappi in policarbonato cromato e schermo in metacrilato satinato. Ottiche speciali disponibili come accessorio.

Ceiling lamps. White painted aluminum body, sides in chromed polycarbonate and shade in satin methacrylate. Special diffusers are available as optional.

Plafonniers, corps en aluminium, terminales en polycarbonate chromé et diffuseur en méthacrylate satiné. Diffuseurs spéciaux disponibles comme accessoire.

Deckenleuchte, Körper aus Aluminium, Seitenteile aus verchromtem Polykarbonat und Diffusor aus satiniertem Methacrylat. Sonder Diffusoren als Zubehör bestellbar.

Lamparas de techo, cuerpo de aluminio pintado blanco, terminales en policarbonato cromado y pantalla in metacrilato satinado. Difusores especiales disponibles como accesorios.

Потолочный светильник. Корпус из окрашенного алюминия, боковые детали из хромированного поликарбоната и абажур из сатинированного метакрилата. Имеются специальные диффузоры как опция.



Lampada da soffitto. Corpo in alluminio anodizzato o verniciato bianco; vetro bianco satinato, nero o metallizzato a specchio.

Ceiling lamp, body in anodized or white painted aluminum; white satin, black or mirror metallized glass.

Plafonnier, corps en aluminium anodisé ou blanc, verre blanc satiné, noir ou métallisé effet miroir.

Wandleuchte (Drehbarkeit 360°). Körper aus Aluminium eloxiert oder weiß lackiert; Glass-Diffusor matt, schwarz oder verspiegelt.

Lampara de techo o colgantes, de aluminio anodizado o pintado blanco; vidrio blanco satinado, negro, o metalizado como uno espejo.

потолочный светильник из анодированного или окрашенного алюминия. Белое сатирированное, черное или зеркальное металлизированное стекло.

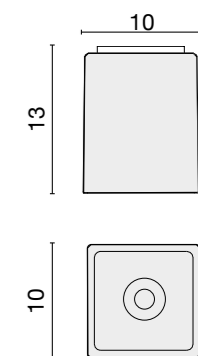

5185 Vetro-Glass	0,8 kg
33W G9 ECO	
40W G9 Decopin	
4W G9 Led	
F	
.55 .57 .59	

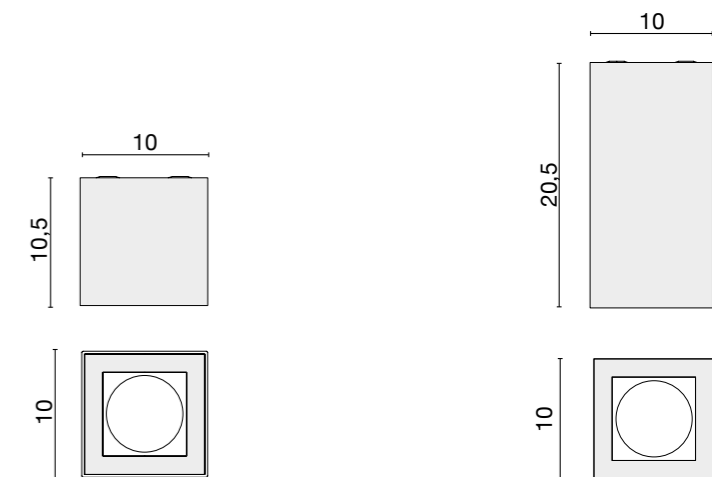

Art. 0205 .01 - .45
Cornice con vetro sabbiato - IP40
Per 5176 lampadina h. max 55mm.

Frame with sandblasted glass - IP40
For 5176 only lamp h. max 55mm.



5176	0,5 kg
50-75W GU10	
8W GU10 Led (cod. 0104)	
5,5W GU10 Led (cod. 0094)	
F	
.01 .45	

5177	0,8 kg
50W E27 PAR20	
16W E27 Fluo EL	
10W E27 Led (cod. 0105)	
F	
.01 .45	

Lampada da soffitto. Corpo in alluminio anodizzato o verniciato bianco; vetro bianco satinato, nero o metallizzato a specchio.

Ceiling lamp, body in anodized or white painted aluminum; white satin, black or mirror metallized glass.

Plafonnier, corps en aluminium anodisé ou blanc, verre blanc satiné, noir ou métallisé effet miroir.

Wandleuchte (Drehbarkeit 360°). Körper aus Aluminium eloxiert oder weiß lackiert; Glass-Diffusor matt, schwarz oder verspiegelt.

Lampara de techo o colgantes, de aluminio anodizado o pintado blanco; vidrio blanco satinado, negro, o metalizado como uno espejo.

потолочный светильник из анодированного или окрашенного алюминия. Белое сатинированное, черное или зеркальное металлизированное стекло.

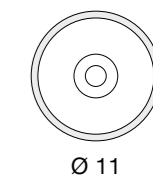
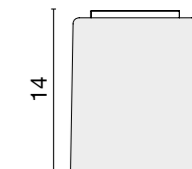

5186 Vetro-Glass	0,8 kg
33W G9 ECO	
40W G9 Decopin	
4W G9 Led	
.55 .57 .59	

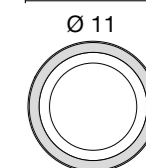
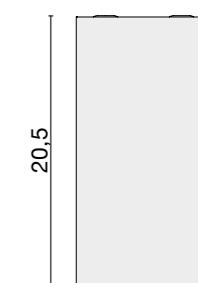
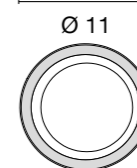
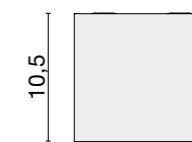

OPTIONAL
 Art. 0204 .01 - .45
 Cornice con vetro sabbato - IP40
 Per 5174 lampadina h. max 55mm.

Frame with sandblasted glass - IP40
 For 5174 only lamp h. max 55mm.



5174	0,4 kg
50-75W GU10	
8W GU10 Led (cod. 0104)	
5,5W GU10 Led (cod. 0094)	
.01 .45	

5175	0,7 kg
50W E27 PAR 20	
16W E27 Fluo EL	
10W E27 Led (cod. 0105)	
.01 .45	



Lampada a plafone in alluminio verniciato bianco. Un sistema d'aggancio magnetico ne facilita l'installazione. Modulo LED CREE con tecnologia True White®.

Lampe à plafond en aluminium verni blanc. Douée d'un système d'ancrage magnétique pour une installation facile. Technologie LED avec module CREE® True White.

Lámpara de techo de aluminio pintado blanco. Un sistema de enganche magnético facilita la instalación. Tecnología LED con módulo CREE® True White.

Ceiling lamp in white lacquered aluminum. Dispose of a magnetic retain system for easy installation. CREE LED module True White® technology.

Deckenleuchte aus Weiß lackiertem Aluminium. Mit magnetische Befestigung zur einfache Installation. LED Technologie, CREE® Modul True White.

Потолочный светильник из алюминия, окрашенного в белый цвет. Легкая фиксация с помощью магнитной системы для крепления. Светодиодная технология с модулем CREE® True White.

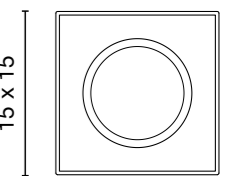

5513

1,3 kg

Led 15W 1000lm CRI > 90 3000K



.01

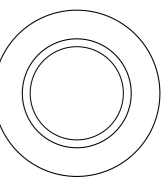

Ø 15

Lampada a plafone in alluminio verniciato bianco. Un sistema d'aggancio magnetico ne facilita l'installazione. Modulo LED CREE con tecnologia True White®.

Lampe à plafond en aluminium verni blanc. Douée d'un système d'ancrage magnétique pour une installation facile. Technologie LED avec module CREE® True White.

Lámpara de techo de aluminio pintado blanco. Un sistema de enganche magnético facilita la instalación. Tecnología LED con módulo CREE® True White.

Ceiling lamp in white lacquered aluminum. Dispose of a magnetic retain system for easy installation. CREE LED module True White® technology.

Deckenleuchte aus Weiß lackiertem Aluminium. Mit magnetische Befestigung zur einfache Installation. LED Technologie, CREE® Modul True White.

Потолочный светильник из алюминия, окрашенного в белый цвет. Легкая фиксация с помощью магнитной системы для крепления. Светодиодная технология с модулем CREE® True White.

5514

1,1 kg

Led 15W 1000lm CRI > 90 3000K



.01



.22

.32

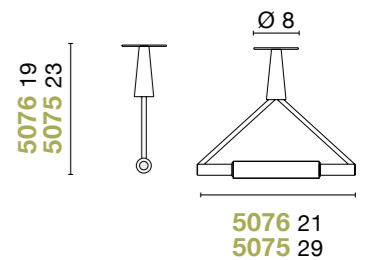

5076 miniteda 0,4 kg

120W R7s (78mm.) ECO

F IP 40

.22 .32

5075 0,6 kg

160W R7s ECO

F IP 40

.22 .32

Lampade da parete e soffitto, struttura in ottone, cromato o nickel satinato. Diffusore in Pirex serigrafato.

Appliques et plafonniers, structure en laiton, chromé ou nickel satiné. Diffuseur en Pyrex sérigraphie.

Lamparas de pared y de techo de latón cromado o níquel satinado. Difusor de vidrio pirex serigrafado.

Wall and ceiling lamps, brass structure, chromed or nickel matt. Silkscreened Pirex glass diffuser.

Wand- und Deckenleuchten, Struktur aus Messing, verchromt oder nickelmatt. Reflektor aus siebdrucktem Pirexglas.

Настенные и потолочные светильники из цвета латунь, хром или матовый никель. Диффузор из боросиликатного стекла пирекс с узором.

Terra - Floor



Alba 334



Arianna 344



Baloon 330



Brigitte 342



Dama 338



Lancia 328

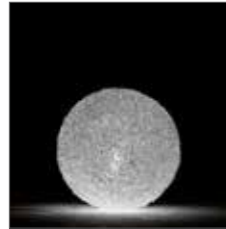

Matassa 332



Olimpia 340



Trifoglio 336



Lampada da terra in alluminio verniciato bianco, diffusore in metacrilato satinato. La versione da terra prevede anche un utilizzo a parete grazie all'apposito attacco incluso. Interruttore touch switch

Floor lamp in white painted aluminum and satin methacrylate diffuser. The floor version includes an additional bracket that allows wall installation. Touch switch

Lampadaire en aluminium laqué blanc et diffuseur en méthacrylate satiné. La version lampadaire est doué d'une patère supplémentaire qui permet l'installation murale. Interrupteur touch switch

Stehleuchten aus weiß lackiertem Aluminium und Diffusor aus satiniertem Acrylglas. Die Stehleuchte bietet eine zusätzliche Halterung für eine etwaige Wandbefestigung. Touch switch Schalter

Lámpara en aluminio pintado blanco y difusor de metacrilato satinado. La versión de pie incluye un soporte adicional que permite la instalación a pared. Interruptor touch switch

Корпус из окрашенного алюминия, диффузор матовый метакрилат. Торшер снабжен кронштейном, позволяющим крепить также к стене. Сенсорный переключатель.

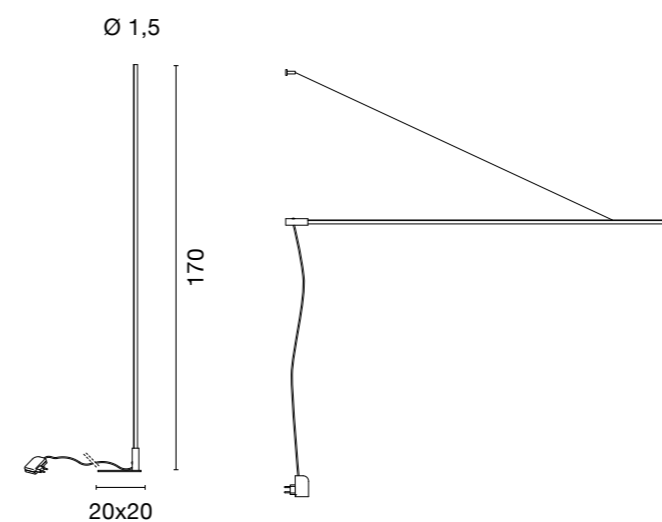

3506 2,5 kg
/ww Led 16,5W 2182lm 3000K
F
.01/WW

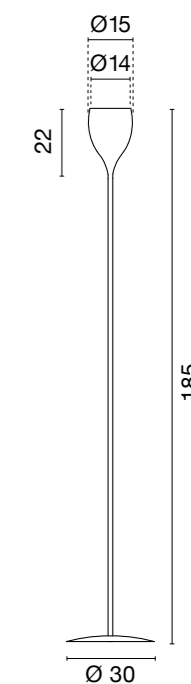

Lampada da terra a luce indiretta in metallo verniciato bianco.
Piastrine LED a tensione di rete 220-240V.

Lampadaire pour lumière indirecte en métal verni blanc.
Platine LED à tension du réseau 220-240V.

Lámpara de pie para iluminación indirecta de metal pintado blanco.
Platina de LED para tension de red 220-240V.

Floor-lamp for indirect lighting in white painted metal.
LED plates for main supply 220-240V.

Stehleuchte für indirekte Beleuchtung. Gestell aus Weiß lackiertem Metall.
LED-Module zum Betrieb an Netzspannung 220-240V.

Напольная лампа отраженного света из окрашенного в белый цвет металла.
Светодиодные платы для подключения напрямую к сети 220в.

3505 4,6 kg

17,5W 1550lm CRI > 80 3000K



.01

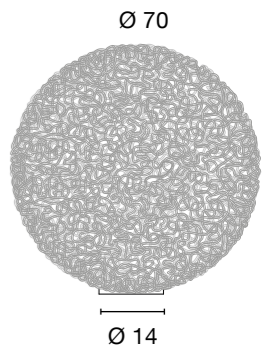
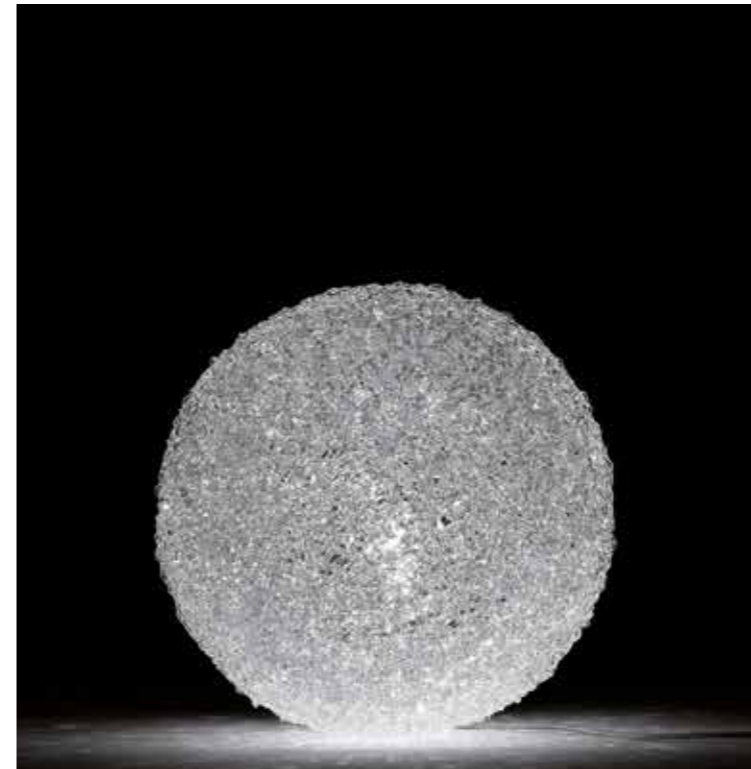

2130	25,7 kg
70W E27 ECO	
30W E27 Fluo EL	
10W E27 Led (cod. 0105)	
.00	



Collezione di lampade in filo di metacrilato extra-chiaro colato con tecnologia Flight-Flow.

Collection of lamps made of clear poured methacrylate yarn with Flight-Flow technology.

Collection de lampes en fil de méthacrylate extra-clair coulé selon la technologie Flight-Flow.

Kollektion Von Leuchten aus Draht aus extraklar Methacrylat verschmolzen mit Flight-Flow Technologie.

Colección de lamparas echas in hilo de metacrilato colado con tecnologia Flight-Flow.

Коллекция светильников, изготовленных вручную из прозрачной метакрилатовой нити по технологии Flight-Flow.

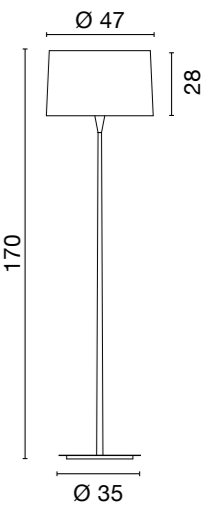
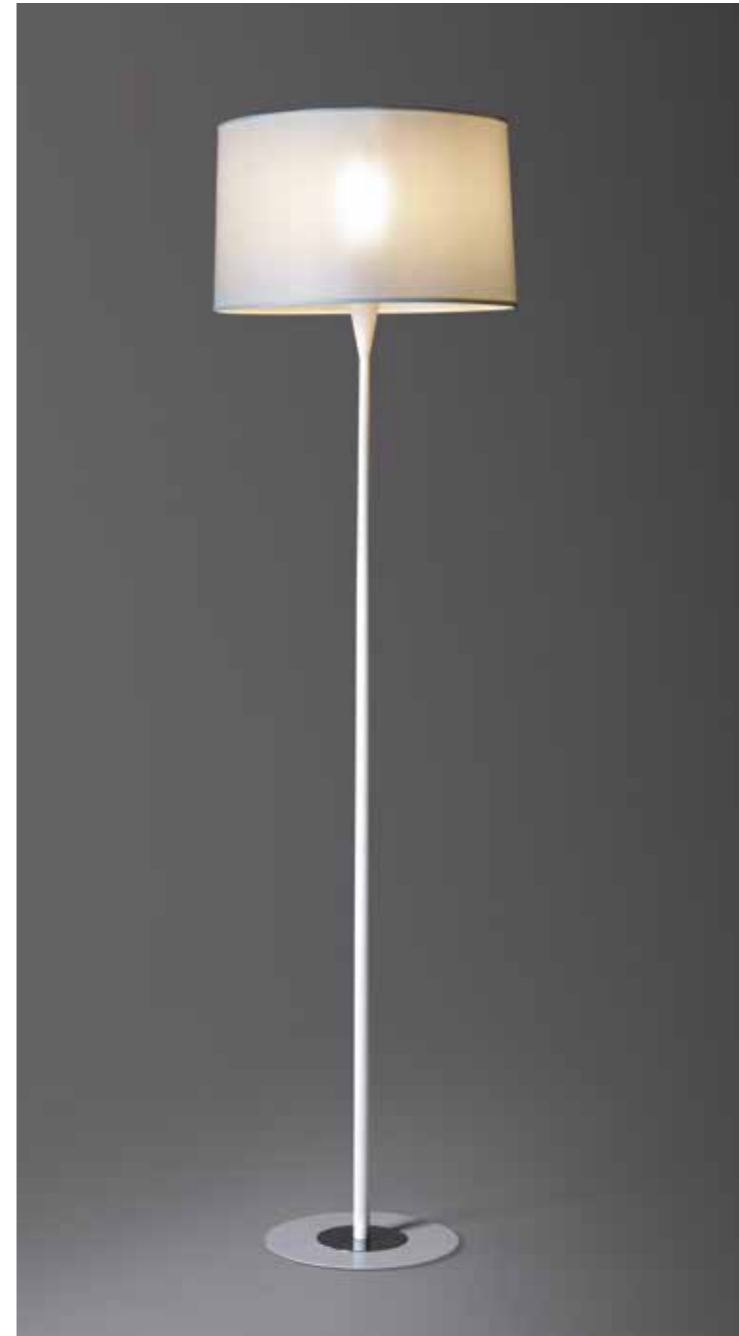

Collezione di lampade con struttura in metallo verniciato bianco, base con particolare in cromo. Paralume in tessuto tecnico bianco (ignifugo). La versione da parete è disponibile con o senza luce LED da lettura

Collection de lampes avec structure en métal verni blanc, base avec détail chromé. Abat-jour en tissu technique blanc (ignifugé). L' applique est disponible avec ou sans lampe de lecture LED

Colección de lamparas con estructura de metal pintado blanco. En la base hay un particular cromado. Sombra de tejido tecnico blanco ignifugo. La aplique es disponible con o sin luz de lectura con LED.

Collection of lamps, frame in white painted metal, base with chromed detail. Shade in white technical fabric (fireproof). Wall model is available with or without LED reading light.

Leuchten-Serie mit Gestell aus weiß lackiertem Metall, Fuß mit verchromtem Detail. Schirm aus weißem technischem (feuerfestem) Stoff. Die Wandleuchte ist mit oder ohne LED leseleuchte bestellbar.

Коллекция светильников из белого окрашенного металла, основание с хромированными деталями. Абажур из белой негорючей ткани. Настенная модель со светодиодным источником света для чтения, или без него.

3098	5,8 kg
70W E27 ECO	
24W E27 Fluo EL	
10W E27 Led (cod. 0105)	
.01	



Collezione di lampade a paralume. con struttura in metallo verniciato bianco o nero.
Le sospensioni e le plafoniere sono dotate di schermo diffusore in metacrilato satinato.
Paralumi in tessuto ignifugo a pieghe bianco o nero.

Collection de lampes avec abat-jour avec structure en métal verni.
Les suspensions et les plafonniers sont livrées avec diffuseur en méthacrylate satiné.
Abat-jour en tissu ignifuge plissé blanc ou noir.

Lamparas con pantalla, estructura de metal pintado blanco o negro.
La version colgante y de techo tiene una difusor de metacrilato satinado.
Pantalla de tejido ignifugo blanco o negro.

Series of shaded lamps with painted metal structures white or black finish..
Suspensions and ceiling lamps are provided with satin methacrylate diffuser.
Lampshades in plissé fireproof cloth white or black.

Kollektion von Schirmleuchten mit Gestell aus weiß oder schwarz lackiertem Metall.
Hänge- und Deckenleuchten sind mit einem Diffusor aus satiniertem Metacrylat ausgestattet. Schirm aus feuerfestem Stoff plissé schwarz oder weiß.

Серия ламп с абажурами. Металлическая структура окрашена в белый или черный цвет. Подвесные светильники с рассеивателем из матового метакрилата и устройством децентрализации. Абажуры из негорючей плиссированной ткани черного и белого цвета.

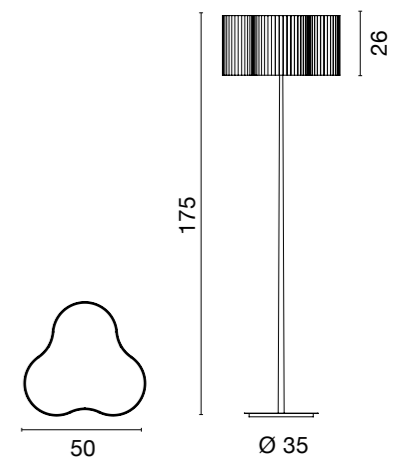

3095	6 kg
70W E27 ECO	
24W E27 Fluo EL	
10W E27 Led (cod. 0105)	
.01 .02	



3091 7,3 kg
205W E27 ECO
F Dim
.57

3092 11,7 kg
Up light: 205W E27 ECO
Down light: 2x42W E27 ECO
F Dim
.57

Lampade da terra o da tavolo con diffusore in vetro soffiato satinato bianco e struttura in nickel satinato.

Table and floor lamps with white blown glass diffuser and structures in nickel matt finish.

Lampes de table et lampadaires avec abat-jour en verre soufflé satiné blanc et structures en finition nickel satiné.

Steh- und Tischleuchten mit Diffusor aus geblasenem satiniertem Glass. Gestell Ausführung nickelmatt.

Lamparas de pie o de sobremesa con pantalla de vidrio soplado satinado blanco. Cuerpo en metal niquelado satinado.

Напольный и настольный светильник из белого дугого стекла. Металлические детали из матового никеля

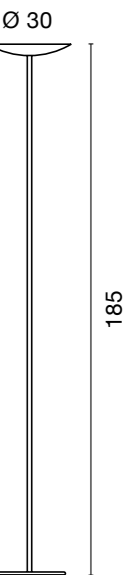
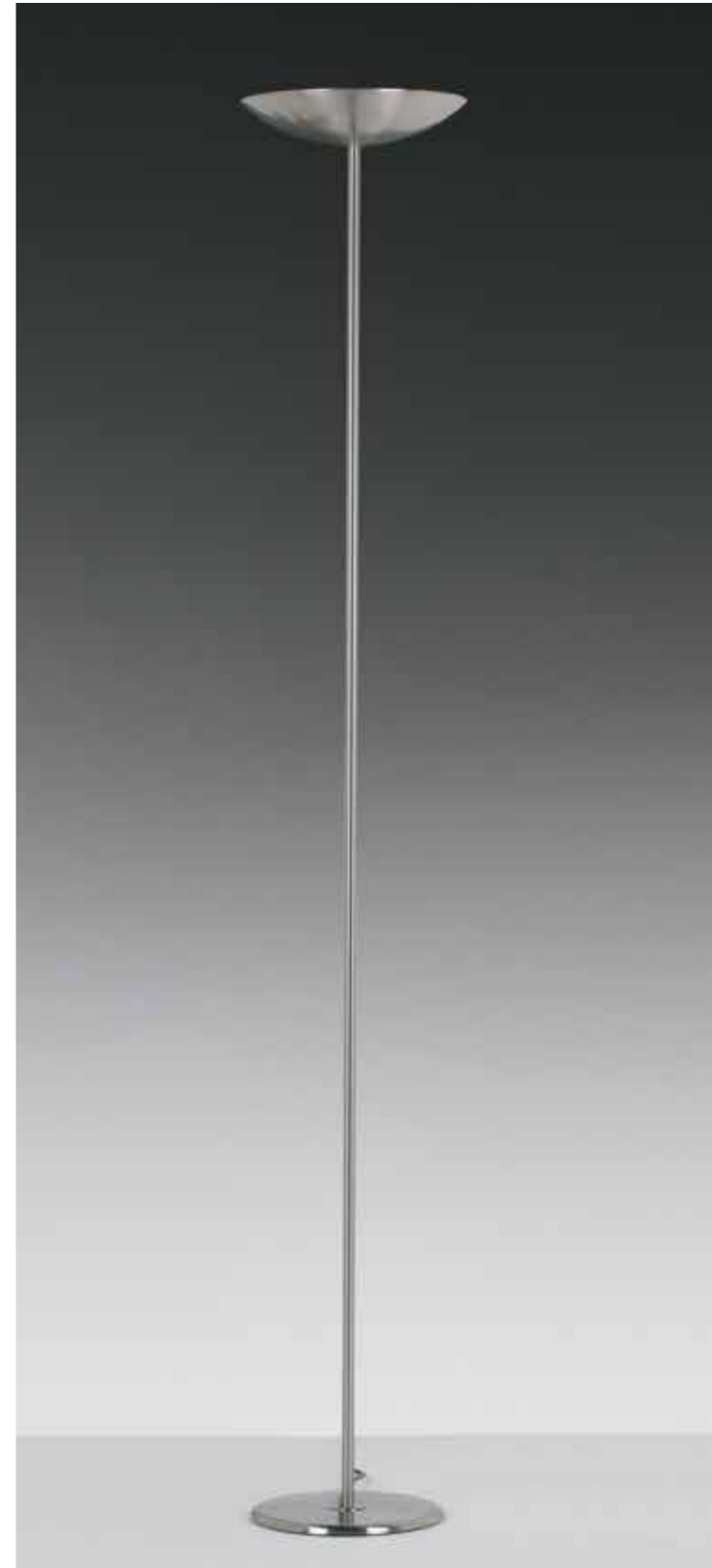

3031 6,3 kg

230W R7s ECO



.01 .20 .32

3032 led 6,8 kg

/WW Led 35W 3100lm 3000K

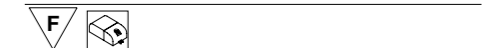

.01/WW .20/WW .32/WW

Lampada da terra in metallo, finiture: ottone lucido, nickel satinato o verniciato bianco.
Versione da terra alogena con dimmer.
Nuovo articolo con piastre LED a tensione di rete 220-240V.

Lampadaire en métal, finition: laiton poli, nickel satiné ou verni blanc.
Lampadaire halogène avec variateur.
Nouveau model avec Platine LED à tension du réseau 220-240V.

Lampara de pie de metal. Acabado: laton pulido, niquel-mat o pintado blanco.
Version de pie halogena es con dimmer.
Nuevo Model con platina de LED para tension de red 220-240V.

Floor lamp in metal, finishes: polished brass, nickel matt or white varnished.
Halogen floor lamp with dimmer.
New item with LED plates for main supply 220-240V.

Stehleuchte aus Metall. Ausführungen: Messing poliert, Nickelmatt oder weiß lackiert.
Halogen Stehleuchte ist mit dimmer.
Neue Modell mit LED-module zum Betrieb an Netzspannung 220-240V.

Настенный светильник из металла: полированной латуни, матированного никеля или белого. Торшер с галогеновой лампой с диммером. Новая модель со светодиодной платой, подключаемой в сеть 220в.

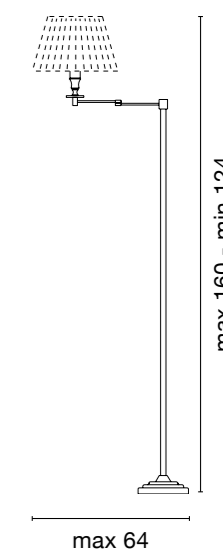

3003

42W E27 ECO

16W E27 Fluo EL

10W E27 Led (cod. 0105)



.20 .26

8 kg



8001

0,25 kg

Paralume in tessuto a pieghe avorio ignifugo
Pleated ivory not inflammable cloth shade

Lampada da terra, tavolo e parete orientabile ed estensibile in ottone lucido o bronzo antico. Paralume in tessuto ignifugo a pieghe color avorio. Versione da terra regolabile in altezza.

Lampadaire, lampe de table et applique extensibles et réglable en laiton poli ou bronze ancien. Abat-jour en tissu plissé ignifuge couleur ivoire. Lampadaire réglable en hauteur.

Lampara de pie, de sobremesa y apliques extensibles de latón dorado o bronce antiguo. Pantalla en tejido plisado ininflamable color marfil. La versión de pie se arregla también en altura.

Extensible and adjustable floor, table and wall lamps in polished brass and dark bronze. Shade in pleated fireproof cloth ivory color. The floor lamp height is adjustable.

Steh-, Tisch und Wandleuchte: schwenkbar und extensibel, aus Messing poliert oder antik Bronze mit plissiertem feuerfestem elfenbeinfarbenem Schirm. Höhenverstellbare Stehleuchte.

Поворотные бра, торшер и настольная лампа из полированной латуни или состаренной бронзы. Абажур из огнестойкой плиссированной ткани цвета слоновой кости. Торшер регулируемой высоты.

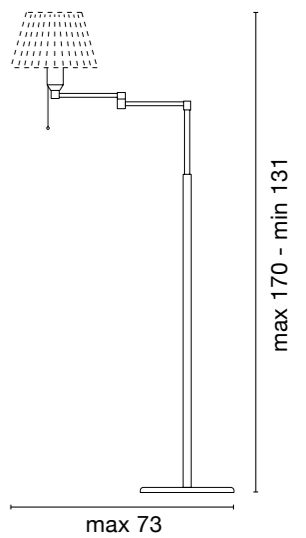

- | | |
|-------------------------|--------|
| 3001 | 9,5 kg |
| 42W E27 ECO | |
| 24W E27 Fluo EL | |
| 10W E27 Led (cod. 0105) | |



.21

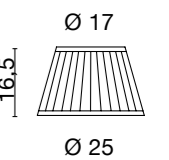

- | | |
|--|---------|
| 8001 | 0,25 kg |
| Paralume in tessuto a pieghe avorio ignifugo | |
| Pleated ivory not inflammable cloth shade | |

Lampade da terra, tavolo e parete estensibile in ottone dorato 24K con interruttore. Paralume in tessuto ignifugo a pieghe color avorio. Versione da terra regolabile anche in altezza.

Lampadaire, lampe de table et appliques extensibles avec interrupteur, finition laiton doré 24K. Abat-jour en tissu plissé ignifuge couleur ivoire. Lampadaire réglable aussi en hauteur.

Lampara de pie ajustable, de sobremesa y apliques extensibles de latón dorado 24K. Con interruptor. Pantalla en tejido plisado ininflamable color marfil. La versión de pie se arregla también en altura.

Extensible floor, table and wall lamps with switch, finish in gold plated 24K. Shade in pleated fireproof cloth ivory color. The floor lamp height is adjustable.

Schwenkbare Steh-, Tisch- und Wandleuchten aus 24K vergoldetem Messing. Schirm aus plisziertem Elfenbeinfarbigem feuerfestem Stoff. Die Stehleuchte ist auch höhenverstellbar.

Настенный поворачивающийся светильник, торшер и настольная лампа из позолоченной латуни (24K). С выключателем. Абажур из огнестойкой плиссированной ткани (цвет – слоновая кость). Торшер регулируемой высоты.

Tavolo - Table



Alba 350



Arianna 362



Brigitte 360



Dama 358



Kalla 348



Llum 354



Matassa 352



Trifoglio 356

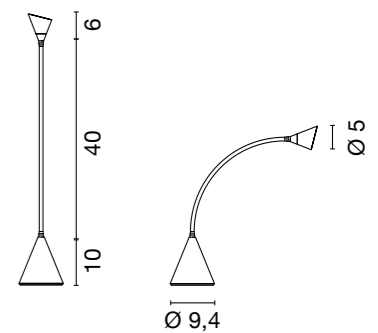
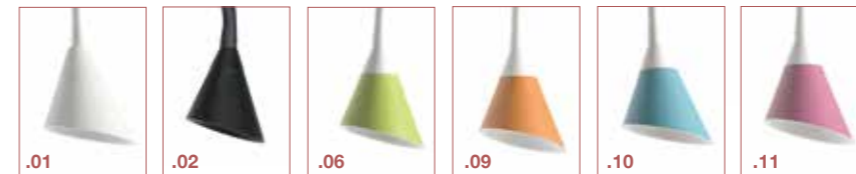

2502 0,9 kg

Led 1W 113 lm 3000K



.01 .02 .06 .09 .10 .11

Lampade orientabili LED da tavolo parete con o senza interruttore (4540). Disponibili in bianco o con cono diffusore colorato o totalmente nera.

Lampes orientables de table ou applique avec ou sans interrupteur(4540). Disponible en blanc, en blanc avec diffuseur en couleur ou tout noir.

Lámparas de mesa o pared orientables con o sin interruptor(4540). Acabado blanco, blanco con difusor coloreado o todo negro.

Adjustable table and wall lamps with or without switch (4540). Available in white, white with colored diffuser or all black.

Verstellbare Tisch- oder Wandleuchten mit oder ohne Schalter(4540). Ausführung weiß, weiß mit farbige Kopf oder komplett Schwarz.

Поворотный настенный и настольный светильник с выключателем или без него (4540).

В белом цвете или в белом цвете с цветным абажуром или полностью черный.

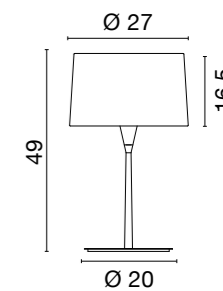

Collezione di lampade con struttura in metallo verniciato bianco, base con particolare in cromo. Paralume in tessuto tecnico bianco (ignifugo). La versione da parete è disponibile con o senza luce LED da lettura

Collection de lampes avec structure en métal verni blanc, base avec détail chromé. Abat-jour en tissu technique blanc (ignifugé). L' applique est disponible avec ou sans lampe de lecture LED

Colección de lamparas con estructura de metal pintado blanco. En la base hay un particular cromado. Sombra de tejido tecnico blanco ignifugo. La aplique es disponible con o sin luz de lectura con LED.

Collection of lamps, frame in white painted metal, base with chromed detail. Shade in white technical fabric (fireproof). Wall model is available with or without LED reading light.

Leuchten-Serie mit Gestell aus weiß lackiertem Metall, Fuß mit verchromtem Detail. Schirm aus weißem technischem (feuerfestem) Stoff. Die Wandleuchte ist mit oder ohne LED leseleuchte bestellbar.

Коллекция светильников из белого окрашенного металла, основание с хромированными деталями. Абажур из белой негорючей ткани. Настенная модель со светодиодным источником света для чтения, или без него.

2117	1,9 kg
42W E27 ECO	
16W E27 Fluo EL	
10W E27 Led (cod. 0105)	
.01	

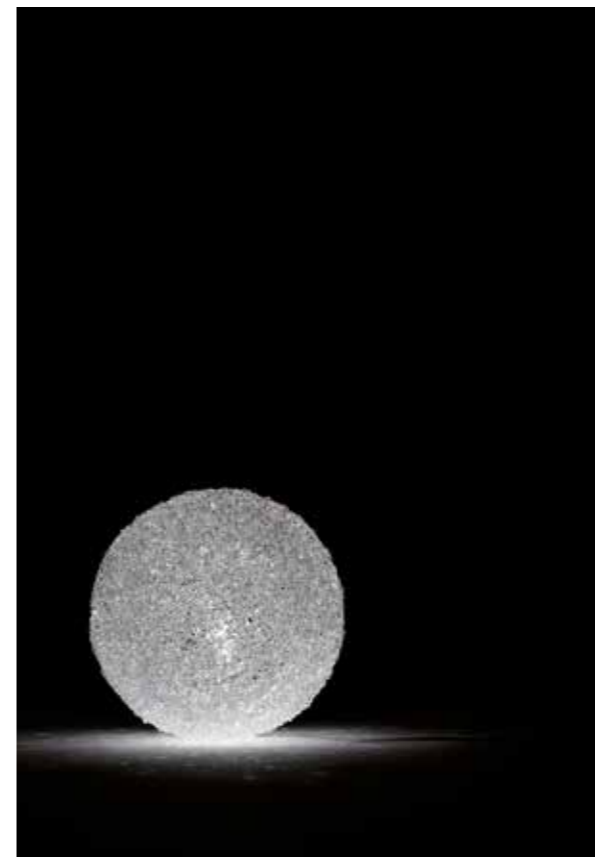

2127 Ø 23
2128 Ø 34
2129 Ø 46

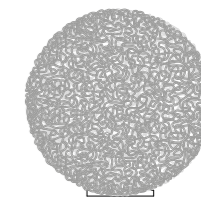

2127 Ø 8,5
2128 Ø 12
2129 Ø 14

2127 2,4 kg

33W G9 ECO 

4W G9 Led 



.00

2128 5,2 kg

42W E27 ECO 

16W E27 Fluo EL 

10W E27 Led (cod. 0105) 



.00

2129 9 kg

53W E27 ECO 

16W E27 Fluo EL 

10W E27 Led (cod. 0105) 



.00

Collezione di lampade in filo di metacrilato extra-chiaro colato con tecnologia Flight-Flow.

Collection de lampes en fil de méthacrylate extra clair coulé selon la technologie Flight-Flow.

Colección de lamparas echas in hilo de metacrilato colado con tecnologia Flight-Flow.

Collection of lamps made of clear poured methacrylate yarn with Flight-Flow technology.

Kollektion Von Leuchten aus Draht aus extraklar Methacrylat verschmolzen mit Flight-Flow Technologie.

Коллекция светильников, изготовленных вручную из прозрачной метакрилатовой нити по технологии Flight-Flow.

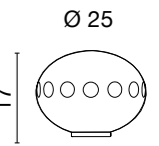

2107 2,5 kg

42W E27 ECO



.57

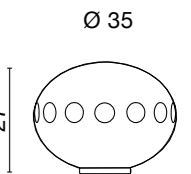

2108 3,1 kg

100W E27 Halolux ECO



.57

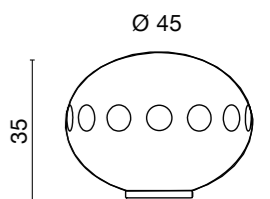

2109 5,1 kg

100W E27 Halolux ECO

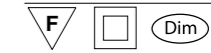

.57

Lampade da tavolo, sospensioni in vetro soffiato satinato bianco.
Strutture in nickel satinato.

Lampes de table, suspensions en verre soufflé satiné opale.
Structures en nickel satiné.

Lamparas de sobremesa y colgantes de cristal soblado satinado blanco.
Cuerpos en metal niquelado satinado.

Table and suspensions lamps in white blown glass. Frames in nickel matt.

Tisch- sowie Pendelleuchten mit Diffusor aus geblasenem Mattglas. Gestell in nickelmatt.

Настольный и подвесной светильник из белого дутого стекла.
Металлические детали из матового никеля.



Collezione di lampade a paralume. con struttura in metallo verniciato bianco o nero. Le sospensioni e le plafoniere sono dotate di schermo diffusore in metacrilato satinato. Paralumi in tessuto ignifugo a pieghe bianco o nero.

Collection de lampes avec abat-jour avec structure en métal verni. Les suspensions et les plafonniers sont livrés avec diffuseur en méthacrylate satiné. Abat-jour en tissu ignifuge plissé blanc ou noir.

Lamparas con pantalla, estructura de metal pintado blanco o negro. La version colgante y de techo tiene un difusor de metacrilato satinado. Pantalla de tejido ignifugo blanco o negro.

Series of shaded lamps with painted metal structures white or black finish. Suspensions and ceiling lamps are provided with satin methacrylate diffuser. Lampshades in plissé fireproof cloth white or black.

Kollektion von Schirmleuchten mit Gestell aus weiß oder schwarz lackiertem Metall. Hänge- und Deckenleuchten sind mit einem Difusor aus satiniertem Metacrylat ausgestattet. Schirm aus feuerfestem Stoff plissé schwarz oder weiß.

Серия ламп с абажурами. Металлическая структура окрашена в белый или черный цвет. Подвесные светильники с рассеивателем из матового метакрилата и устройством децентрализации. Абажуры из негорючей плиссированной ткани черного и белого цвета.

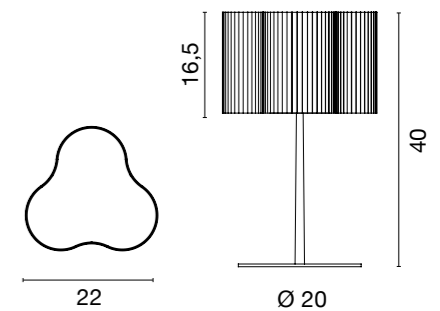

2115 1,9 kg
 42W E14 ECO
 11W E14 Fluo EL
 F □
 .01 .02

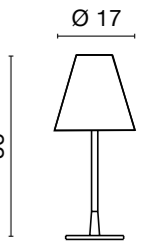

2110 1,3 kg
42W E14 ECO
F □
.57

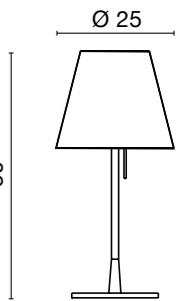

2111 2,9 kg
70W E27 ECO
21W E27 Fluo EL
10W E27 Led (cod. 0105)
F □
.57

Lampade da tavolo con diffusore in vetro soffiato satinato bianco e struttura in nickel satinato.

Lampes de table avec abat-jour en verre soufflé satiné blanc et structures en finition nickel satiné.

Lamparas de sobremesa con pantalla de vidrio soplado satinado blanco. Cuerpo en metal niquelado satinado.

Table lamps with white blown glass diffusor and structures in nickel matt finish.

Tischleuchten mit Diffusor aus geblasenem satinierem Glass. Gestell Ausfuehrung nickelmatt.

Настольный светильник из белого дутого стекла. Металлические детали из матового никеля

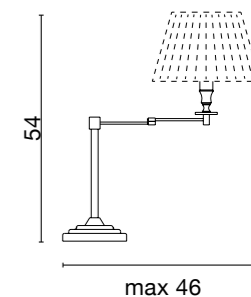

2003	2,7 kg
42W E27 ECO	
16W E27 Fluo EL	
10W E27 Led (cod. 0105)	
F	
.20 .26	

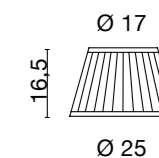

8001	0,25 kg
Paralume in tessuto a pieghe avorio ignifugo	
Pleated ivory not inflammable cloth shade	

Lampada da tavolo orientabile ed estensibile in ottone lucido o bronzo antico. Paralume in tessuto ignifugo a pieghe color avorio.

Lampe de table et extensible et réglable en laiton poli ou bronze ancien. Abat-jour en tissu plissé ignifuge couleur ivoire.

Lampara de sobremesa y apliques extensibles de latón dorado o bronce antiguo. Pantalla en tejido plisado ininflamable color marfil.

Extensible and adjustable table lamp in polished brass and dark bronze. Shade in pleated fireproof cloth ivory color.

Tischleuchte schwenkbar und extensibel, aus Messing poliert oder antik Bronze mit plissiertem feuerfestem elfenbeinfarbenem Schirm.

Настольная лампа из полированной латуни или состаренной бронзы. Абажур из огнестойкой плиссированной ткани цвета слоновой кости.

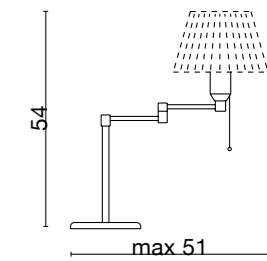

2042	3 kg
42W E27 ECO	
16W E27 Fluo EL	
10W E27 Led (cod. 0105)	
.21	

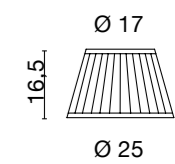

8001	0,25 kg
Paralume in tessuto a pieghe avorio ignifugo	
Pleated ivory not inflammable cloth shade	

Lampade tavolo estensibile in ottone dorato 24K con interruttore. Paralume in tessuto ignifugo a pieghe color avorio.

Lampe de table extensible avec interrupteur, finition laiton doré 24K. Abat-jour en tissu plissé ignifuge couleur ivoire.

Lampara adjustable de sobremesa y apliques extensible de latón dorado 24K. Con interruptor. Pantalla en tejido plisado ininflamable color marfil.

Extensible table lamp with switch, finish in gold plated 24K. Shade in pleated fireproof cloth ivory color.

Tischleuchte aus 24K vergoldetem Messing. Schirm aus plissiertem Elfenbeinfarbigem feuerfestem Stoff.

Настольная лампа из позолоченной латуни (24K). С выключателем. Абажур из огнестойкой плиссированной ткани (цвет – слоновая кость).

Bagno - Bathroom



Key 376



Morning 370



Siba 366



Therma 378



Twin 374



Lampade da parete o soffitto in alluminio e diffusore policarbonato.
Terminali in policarbonato cromato.
Nuovo articolo con piastre LED.

Wall or ceiling lamps with aluminum frame and polycarbonate shade.
Stoppers in chromed polycarbonate.
New item with LED plates.

Appliques ou plafonniers en aluminium, diffuseur en polycarbonate.
Terminales en polycarbonate chromé.
Nouveau model avec Platine LED.

Wand- Deckenleuchten aus Aluminium, Diffusor aus Polykarbonat.
End-Teile aus verchromtem Polykarbonat.
New item with LED plates.

Lamparas de pared o the techo en aluminio y difusor en policarbonato satinado.
Terminales de policarbonato cromado.
Nuevo Model con platina de LED.

Настенные или потолочные лампы из алюминия, диффузор из поликарбоната. Кронштейны из хромированного поликарбоната.
Новая модель со светодиодными платами.



4327 Siba 33 0,6 kg
 8W G5 T5
 F IP 44
 .31

4331 Siba 33 led 0,7 kg
 /W Led 6,25W 793lm 4000K
 /WW Led 6,25W 751lm 3000K
 F IP 44
 .31/W .31/WW

4328 Siba 60 1 kg
 14W G5 T5
 F IP 44
 .31

4333 Siba 60 led 1,1 kg
 /W Led 12,5W 1585lm 4000K
 /WW Led 12,5W 1502lm 3000K
 F IP 44
 .31/W .31/WW

4329 Siba 90 1,4 kg
 21W G5 T5
 F IP 44
 .31

4330 Siba 120 1,8 kg
 28W G5 T5
 F IP 44
 .31

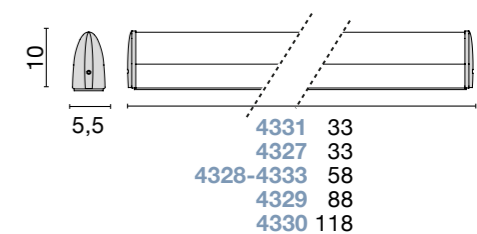



Lampade da parete o soffitto in alluminio, diffusore in policarbonato.
Terminali in policarbonato cromato.

Wall or ceiling lamps in aluminum, polycarbonate diffuser.
Stoppers in chromed polycarbonate.

Appliques or plafonniers en aluminium, diffuseur en polycarbonate.
Terminales en polycarbonate chromé.

Wand- Deckenleuchten aus Aluminium Diffusor aus Polykarbonat.
End-Teile aus Verchromtem Polykarbonat.

Lamparas de pared o de techo en aluminio y difusor en policarbonato.
Terminales de policarbonato cromado.

Настенные или потолочные лампы из алюминия, диффузор из поликарбоната. Кронштейны из хромированного поликарбоната.

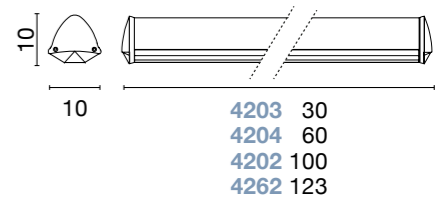

4202 Morning 100 2,7 kg
 39W G5 T5
 F IP 44 .31

4203 Morning 30 1 kg
 11W 2G7
 F IP 44 .31

4204 Morning 60 1,5 kg
 40W 2G11
 F IP 44 .31

4262 Morning 120 3,2 kg
 54W G5 T5
 F IP 44 .31

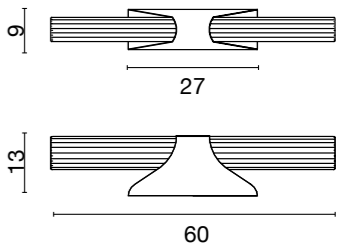
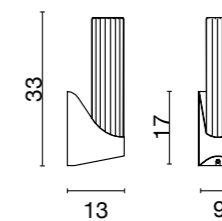

4235 Twin Uno

0,6 kg

18W 2G11

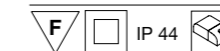

.31

4236 Twin Due

1 kg

2x18W 2G11



.31

Lampade da parete in policarbonato con copertura in alluminio cromato.
Diffusore in policarbonato opalino "multirighe".

Appliques en polycarbonate avec manteau en aluminium chromé.
Diffuseur en polycarbonate opale rayé.

Appliques en policarbonato con cobertura en aluminio cromado.
Difusor en policarbonato satinado a rayas.

Wall lamps in polycarbonate and cover in chromed aluminum.
Diffuser in white striped polycarbonate.

Wandleuchten aus Polykarbonat mit verchromter Metallabdeckplatte.
Reflektor aus weissem liniertem Polykarbonat.

Настенный светильник из с полоской из поликарбоната с хромированными деталями.
Диффузор из опалового поликарбоната с узором.

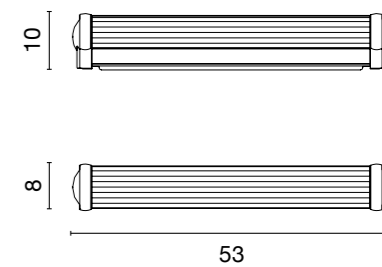

4242 1 kg

2x11W 2G7

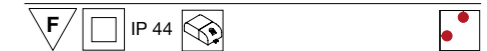

.31

Lampada da parete in policarbonato con tappi cromati. Diffusore in policarbonato satinato.

Applique en polycarbonate avec terminales chromés. Diffuseur en polycarbonate satiné.

Applique en policarbonato con terminales de policarbonato cromado. Difusor de policarbonato satinado.

Wall lamp in polycarbonate with chromed covers. Diffuser in satin polycarbonate.

Wandleuchte aus verchromtem Polykarbonat. Difusor aus satiniertem Polykarbonat.

Настенный светильник из поликарбоната с хромированными деталями. Матовый рассеиватель из поликарбоната.



4261 Therma 60 1,5 kg

40W 2G11



.31

Lampade da parete con corpo in metallo e diffusore policarbonato.
Terminali in policarbonato cromato.

Wall lamps with metal frame and polycarbonate shade.
Stoppers in chromed polycarbonate.

Appliques ou plafonniers, corps en métal et diffusor en polycarbonate.
Terminales en polycarbonate chromé.

Wandleuchten aus Metall und Diffusor aus Polykarbonat.
End-Teile aus verchromtem Polykarbonat.

Lamparas de pared en metal y difusor en policarbonato satinado.
Terminales de policarbonato cromado.

Настенный светильник с корпусом из алюминия, диффузор из поликарбоната.
Детали хромированные.

Numerical Index

1104	Liola 17	138
1106	Liola 35	138
1107	Liola 25	138
1108	Liola 42	138
1123	Desk	224
1124	Desk fluo	224
1127	Llum 25	130
1128	Llum 35	130
1129	Llum 45	130
1133	Mir	142
1143	Maya	140
1147	Alea	112
1148	Fokus	116
1151	Desk Maxi	124
1155	Bibox	128
1156	Bibox	128
1162	Alea	112
1163	Fokus	116
1164	Trifoglio	134
1166	Seta	136
1167	Phantom	120
1168	Phantom	120
1169	Phantom Maxi	122
1170	Phantom Maxi	122
1504	Pool	96
1505	Milady	100
1506	Mork Sistema	92
1507	Mork	90
1510	Ruò	108
1512	Kappa led	72
1513	Kappa	72
1514	Lei	78
1515	Lui	80
1516	Prêt-à-Porter	106
1517	Matassa 23	104
1518	Matassa 34	104
1519	Matassa 46	104
1521	Aerostat	82
1523	Giara	86
1524	Phantom led	120
1525	Phantom led	120
1530	Megavide	52
1531	Megavide	52
1532	Megavide	52
1535	Spirit	58
1540	Lancia	62
1541	Rail	66
1542	Rail	66
1543	Rail Sistema	68
1544	Rail Sistema	68
1550	Baloon	98
2003	Brigitte	362
2042	Arianna	360
2107	Llum 25	354
2108	Llum 35	354

2109	Llum 45	354
2110	Dama 15	358
2111	Dama 25	358
2115	Trifoglio	356
2117	Alba	350
2127	Matassa 23	352
2128	Matassa 34	352
2129	Matassa 46	352
2130	Matassa 70	332
2502	Kalla	348
3001	Arianna	344
3003	Brigitte	342
3031	Olimpia	340
3032	Olimpia led	340
3091	Dama 35	338
3092	Dama 42	338
3095	Trifoglio	336
3098	Alba	334
3505	Baloon	330
3506	Lancia	328
4004	Arianna	234
4005	Brigitte	236
4006	Arianna	234
4007	Lynx	230
4021	Fusò 30	202
4023	Fusò 40	202
4046	Olimpia	200
4051	Miniolimpia	200
4052	Olimpia led	200
4092	Drim 30	208
4093	Drim 40	208
4098	Drim Angolo	208
4133	Ekus	232
4137	Miniteda	218
4138	Teda	218
4155	Ikon Maxi	222
4156	Ikon	222
4175	Minipathos	213
4178	Quinta	206
4195	Monet	228
4202	Morning 100	370
4203	Morning 30	370
4204	Morning 60	370
4209	Liola	204
4235	Twinuno	374
4236	Twindue	374
4242	Key	376
4249	Frida 26	210
4251	Frida 32	210
4259	Yoda	216
4260	Yoda	216
4261	Therma 60	378
4262	Morning 120	370
4265	Maya 20	214

4266	Maya 40	214
4271	Akuta	220
4272	Akuta	220
4273	Akuta halo	220
4281	Alea	192
4282	Alea	192
4286	Fokus	196
4287	Fokus	196
4288	Trace halo	188
4289	Trace fluo	188
4294	Slash	186
4295	Slash	186
4300	Sail 65 fluo	269
4303	Sail 95 fluo	269
4305	Sail 37 fluo	269
4320	Rap	190
4321	Rap halo	190
4325	Tekna halo	184
4326	Tekna fluo	184
4327	Siba 33	368
4328	Siba 60	368
4329	Siba 90	368
4330	Siba 120	368
4331	Siba led	368
4333	Siba led	368
4378	Quinta	206
4392	Alba	182
4393	Alba led	182
4501	Kalla	174
4503	Kirk	224
4504	Ikon Led	222
4505	Read	226
4525	Baloon	178
4526	Flan	256
4527	Flan	256
4533	Matassa 34	180
4534	Matassa 46	180
4540	Kalla due	176
4541	Kalla due	176
4542	Fusò led	202
4543	Fusò led	202
4545	Drim led	208
4546	Drim led	208
4548	Quinta led	206
4549	Frida 26 led	210
4550	Frida 32 led	210
4553	Liola led	204
4561	Alealed	164
4564	Mats	148
4565	Mats	148
4567	Lancia	160
4568	Lancia	160
4569	Lancia	160
4571	Pupilla	156
4572	Pupilla	156
4574	Ci 62	152

4575	Ci 92	152
4576	Ci 122	152
4577	Ci 152	152
4578	Rail	170
4579	Rail	170
4580	Rail Sistema	172
4581	Rail Sistema	172
5003	Trifoglio	302
5008	Helios 25	276
5009	Helios 35	276
5010	Helios 45	277
5011	Helios 60	277
5013	Minipin	288
5017	Disco	294
5038	Luna	296
5039	Luna	296
5075	Teda	324
5076	Miniteda	324
5095	Mirò 34	273
5096	Mirò 44	273
5098	Mirò 58	272
5132	Frida 30	282
5134	Frida 40	282
5139	Frida 45	282
5141	Tondapin	288
5142	Quadrapi	288
5150	Frida 20	282
5151	Flip	284
5154	Flip Maxi	286
5155	Flip Maxi	286
5156	Magnum Quadro	262
5157	Magnum Quadro em	262
5159	Flip Maxi led	286
5160	Trendy 35	266
5162	Trendy 35 em	266
5165	Trendy 45	266
5167	Trendy 45 em	266
5170	Trendy	266
5172	Trendy em	266
5174	Fokus	318
5175	Fokus	318
5176	Alea	314
5177	Alea	314
5185	Alea	314
5186	Fokus	318
5198	Mirò 58	272
5209	Helios 35	276
5210	Helios 45	277
5211	Helios 60	277
5212	Ringo 22	280
5213	Ringo 32	280
5214	Ringo 32 fluo	280
5215	Magnum Tondo	260
5216	Magnum Tondo em	260
5218	Musa 22 halo	278

5219	Musa 32 halo	278
5220	Musa 32 fluo	278
5221	Echo	290
5222	Fusion	292
5223	Phantom 90	308
5224	Phantom 120	308
5225	Phantom Maxi 90	310
5226	Phantom Maxi 120	310
5227	Kappa led	252
5228	Kappa flou	252
5229	Matassa 23	306
5230	Matassa 34	306
5233	Prêt-à-Porter	304
5234	Musa 40	278
5235	Musa 40 led	278
5238	Trendy led	266
5295	Mirò 34 em	273
5296	Mirò 44 em	273
5298	Mirò 58 em	272
5395	Mirò 34 fluo	273
5396	Mirò 44 fluo	273
5513	Alea Maxi	320
5514	Focus Maxi	322
5518	Musa led	278
5519	Musa led	278
5520	Drum	244
5521	Frida led	282
5522	Frida led	282
5525	Helios led	276
5526	Helios led	276
5527	Helios led	277
5528	Helios led	277
5531	Tondapin led	288
5532	Quadrapi led	288
5533	Flip led	284
5536	Megavide	300
5537	Megavide	300
5539	Roc	240
5540	Rail	246
5541	Rail	246
5542	Rail Sistema	248
5543	Rail Sistema	248
5596	Mirò led	272

Lampadine - Bulbs

12V



0071
12V 50W GU 5,3 Ø 5

LED



0094
5,5W GU10 LED 3000K



0104
8W GU10 LED



0105
10W E27 LED



0106
16W E27 PAR 30 LED

230V



0072
50W GU 10



0072/G
75W GU 10



0092/20
20W G9 ECO

0092/33
33W G9 ECO

0092/48
48W G9 ECO

0092/60
60W G9 ECO



0048/ECO
120W R7s (78mm.)



0049/ECO
120W R7s ECO

0050/ECO
160W R7s ECO

0051/ECO
230W R7s ECO



0074
50W E27 PAR 20



0075
75W E27 PAR 30

FLUO

3000K



0077/E
42W GX24 q.4
0088/E
13W G24 q.1
0085/E
18W G24 q.2
0086/E
26W G24 q.3

4000K



0082
18W 2G11
0083
24W 2G11
0084
36W 2G11

4000K



0100
22W T5 2GX13 FC
0101
40W T5 2GX13 FC
0102
55W T5 2GX13 FC



I nostri prodotti sono costruiti in conformità alle norme europee CEI-EN 60598 e, come tali, recano la marcatura CE.

Our fittings are manufactured in conformity with the european standard CEI-EN 60598 and, consequently, get the mark CE.

Nos appareils sont fabriqués en conformité aux règles européennes CEI-EN 60598 et, par conséquence, fournis avec marque CE.

Unsere Produkte werden gemäss europäischer Norm CEI-EN 60598 hergestellt und sind als solche mit dem CE-Zeichen gekennzeichnet.

Nuestros productos son fabricados de conformidad con las normas europeas UNE EN 60598 y, como tal, lleva la marca CE.

Наши изделия изготовлены в соответствии с европейскими нормами CEI-EN 60598 и поэтому отмечены знаком CE.

Egoluce s.r.l. si riserva la facoltà di modificare, in qualsiasi momento e senza preavviso, le caratteristiche tecniche dei modelli illustrati nel presente catalogo. I colori si intendono indicativi.

Egoluce s.r.l. reserves the right to change, at any time and without prior warning, the technical specification of any product illustrated in this catalogue. Colours are simply indicative of the real nuance.

Egoluce s.r.l. se réserve le droit de modifier, à n'importe quel moment et sans préavis, les caractéristiques techniques des éléments illustrés dans ce catalogue. Les couleurs sont simplement a titre indicatif.

Egoluce s.r.l. behält sich vor, jederzeit und fristlos die in beiliegendem Katalog erläuterten technischen Daten zu ändern. Die Farben sind nicht genau wirklichkeitsgetreu.

Egoluce s.r.l. Nos reservamos el derecho de cambiar, en cualquier momento y sin previo aviso de las especificaciones de los productos mostrados en este catálogo. Los colores son aproximados.

Фабрика Egoluce s.r.l. сохраняет за собой право в любое время и без предварительного уведомления менять технические спецификации любого изделия в этом каталоге.

ASSOLUCE
FEDERLEGNO-ARREDO

ECO LIGHT

Foto e grafica: Bordegoni srl

Per le pagine 208-209 si ringrazia:
Anton Balazh e Marina and Ali Urmancheevi

Collaborazione studio KEYART.

Stampa: Rotolito Lombarda 2015

ciao Andrea, e grazie!

Finiture - Finishes

00	Trasparente Clear Transparent Klar Transparente Прозрачный	10	Azzurro Light blue Bleu ciel Hellblau Azul claro Голубой	29	Foglia oro Gold leaf Feuille d'or Blattgold Hoja de oro Сусальное золото	45	Alluminio anodizzato Aluminium anodized Aluminium anodisé Aluminium eloxiert Aluminio anodizado Анодированный алюминий
01	Bianco White Blanc Weiss Blanco Белый	11	Rosa Pink Rose Rose Rosa Пинк	31	Cromato Chromed Chromé Verchromt Cromado Хромированный	50	Cristallo Crystal Cristal Kristall Cristal Хрусталь
02	Nero Black Noir Schwarz Negro Черный	12	Verniciato Wengé Wenge finish Finition Wengé Ausführung Wengé Acabado Wengué Цвет венге	32	Nickel satinato Nickel mat Nickel satiné Nickelmatt Niquel mate Матовый никель	54	Vetro blu Blue glass Verre bleu Blau es Glas Vidrio azul Синее стекло
03	Grigio Grey Gris Grau Gris Серый	13	Verniciato legno sbiancato Bleached wood finish Finition bois blanchi Ausführung bleichen Holz Acabado madera blanqueado Цвет выбеленное дерево	33	Acciaio satinato Matt-steel Acier satiné Mattedelstahl Acero mate Матовая сталь	55	Vetro cromato Chromium glass Verre chromé Glas verchromt Vidrio cromado Хромированное стекло
04	Grigio fumé Smoked grey Gris fumé Rauchgrau Gris humo Серый дымчатый	20	Ottone lucido Polished brass Laiton poli Messing poliert Latòn brillo Полированная латунь	35	Sabbia Sand Sable Sand Arenoso Nesok	57	Vetro bianco White glass Verre blanc Weisses Glas Vidrio blanco Белое стекло
06	Verde Green Vert Grün Verte Зеленый	21	Dorado 24K Gilded 24K Doré 24K Vergoldet 24K Daurado 24K Позолоченный 24K	36	Tessuto nero Black cloth Tissu noir Stoffschwarz Tejido negro Черной ткани	59	Vetro nero Black glass Verre noir Scharz Glas Vidrio negro Черный стекло
07	Blu Blue Bleu Blau Azul Синий	22	Ottone cromato Chromed brass Laiton chromé Messing chrom Latòn cromado Хромированная латунь	37	Tessuto grigio perla Pearl grey cloth Tissu gris perle Stoffperlgrau Tejido gris perla Серой ткани	60	Vetro ambra chiaro Light amber glass Verre ambre claire Helles amber Glas Прозрачное янтарное стекло
09	Arancione Orange Orange Orange Naranja Оранжевый	26	Bronzo antico Dark bronze Bronze Antik bronze Bronzo antiguo Состаренная бронза	40	Grigio Grey Gris Grau Gris Серый		



Foro incasso.
Cut out.
Trou d'encastrement.
Ausschnitt.
Foro encastramento.
Отверстие под светильник



Dimmer incluso
Dimmer included
Dimmer inclus
Dimmer inklusiv
Dimmer incluido
с диммером



Lunghezza cavo
Cable length
Longueur du câble
Kabel Länge
Largura cable
кабелем длиной



Alimentatore incluso – Alimentatore non incluso
Converter included – Converter not included
Convertisseur inclus – Convertisseur pas inclus
Inklusiv Konverter – Konverter nicht mitgeliefert
Convertidor incluido – Convertidor no incluido
С КОНВЕРТЕРОМ - БЕЗ КОНВЕРТЕРА

/W Led **Natural White**
3500K - 4200K

/WW Led **Warm White**
2700K - 3200K

/CW Led **Cold White**
5000K - 6000K

/EM Emergenza
Emergency

Marchi - Marks



Apparecchio in Classe II, munito di isolamento doppio o rinforzato.
Fixture on Class II, with double or reinforced insulation.
Appareil en Classe II, équipé d'isolation double ou renforcé.
Gerät, Klasse II, mit doppelter oder verstärkter Isolierung.
Aparatos de clase II, con aislamiento doble o reforzado.
Световой прибор со вторым классом защиты, с двойной или армированной изоляцией



Apparecchio adatto ad essere installato su superfici normalmente infiammabili.
Fixture ready for mounting on normally inflammable surfaces.
Appareil pouvant être installé sur des surfaces enflammables.
Apparat, der auf normal entflammbare Oberflächen angebracht werden kann.
Aparados adecuado para ser instalado en normalmente inflamable.
Световой прибор может монтироваться на горючую поверхность.



Apparecchio a bassissima tensione con trasformatore remoto.
SELV fixture with remote transformer.
Appareil à très basse tension avec transformateur à distance.
Niederspannung Gerät mit entferntem trafo.
Aparatos en bassissima tensione con trasformatore Remoto.
Низковольтный световой прибор с удаленным трансформатором

1a cifra protezione alla penetrazione di corpi solidi.
1st digit: protection against penetration by solid bodies.
1re chiffre: protection contre la pénétration des corps solides.
1a Ziffer: gegen feste Körper geschützt.
1o Dígito: a la protección la penetración de cuerpos sólidos.
1-ая цифра: защита от проникновения твердых предметов

0
 Non protetto.
 No protection.
 Sans protection.
 Nicht geschützt.
 Sin protección.
 Не защищено

1
 Protetto da corpi solidi superiori a 50mm.
 Protected against solid matters (over 50mm).
 Protégé contre objets solides de plus de 50mm.
 Gegen feste Körper über Ø 50 mm geschützt.
 Protegido contra objetos sólidos mayores a 50 mm.
 Защищено от предметов более 50мм

2
 Protetto da corpi solidi superiori a 12mm.
 Protected against solid matters (over 12mm).
 Protégé contre objets solides de plus de 12mm.
 Gegen feste Körper über Ø 12mm geschützt.
 Protegido contra objetos sólidos mayores a 12 mm.
 Защищено от предметов более 12мм

3
 Protetto da corpi solidi superiori a 2,5mm.
 Protected against solid matters (over 2,5mm).
 Protégé contre objets solides de plus de 2,5mm.
 Gegen feste Körper über Ø 2,5mm geschützt.
 Protegido contra objetos sólidos superiores a 2,5mm.
 Защищено от предметов более 2,5мм

4
 Protetto da corpi solidi superiori a 1mm.
 Protected against solid matters (over 1mm).
 Protégé contre objets solides de plus de 1mm.
 Gegen feste Körper über Ø 1mm geschützt.
 Protegido contra objetos sólidos superiores a 1mm.
 Защищено от предметов более 1мм.

5 
 Protetto contro la polvere.
 Dust proof.
 Protégé contre la poussière.
 Staubgeschützt.
 Protegido contra el polvo.
 Защищено от пыли.

6 
 Totalmente protetto contro la polvere.
 Fully dust proof.
 Protégé totalement contre la poussière.
 Staubdicht.
 Totalmente protegido contra el polvo.
 Полностью защищено

2a cifra protezione contro la penetrazione d'acqua.
2nd digit: protection against penetration by water.
2me chiffre: protection contre la pénétration de l'eau.
2a Ziffer: wassergeschützt.
2o Dígito: a la protección la penetración de l'agua.
2-ая цифра: защита от проникновения воды

0
 Non protetto.
 No protection.
 Sans protection.
 Nicht geschützt.
 Sin protección.
 Не защищено.

1 
 Protetto contro la caduta verticale di gocce d'acqua.
 Protected against drops of water falling vertically.
 Protégé contre les chutes verticales des gouttes d'eau
 Tropfwassergeschützt.
 Protegido contra la caída vertical de gotas de agua.
 Защищено от вертикальных капель воды.

3 
 Protetto contro la pioggia.
 Rain proof fixture.
 Protégé contre la pluie.
 Regengeschützt.
 Protegido contra la lluvia.
 Защищено от дождя.

4 
 Protetto contro gli spruzzi.
 Splash proof fixture.
 Protégé contre les projections d'eau.
 Spritzwassergeschützt.
 Protegido contra salpicaduras de agua.
 Защищено от брызг.

5 
 Protetto contro getti d'acqua.
 Water jet proof.
 Protégé contre les jets d'eau.
 Strahlwassergeschützt.
 Protegido contra chorros de agua.
 Защищено от потоков воды.

6
 Protetto contro le ondate.
 Wave proof.
 Protégé contre les vagues.
 Wellengeschützt.
 Protegido contra mar gruesa.
 Защищено от волн.

7 
 Protetto contro immersione.
 Watertight immersion fixture.
 Étanche pour immersion.
 Eintauchenwassergeschützt.
 Protegido contra la inmersión.
 Защищено от погружения в воду.

 Sospensione
 Suspension
 Suspension
 Pendelleuchte
 Colgante
 Подвесной светильник

 Lampada da tavolo
 Table lamp
 Lampe de table
 Tischleuchte
 Lampara de sobremesa
 Настольная лампа

 Lampada da terra
 Floor lamp
 Lampadaire
 Stehleuchte
 Lampara de pie
 Торшер

 Lampada da parete
 Wall lamp
 Applique
 Wandleuchte
 Applique
 Бра

 Lampada da soffitto
 Ceiling lamp
 Plafonnier
 Deckenleuchte
 Lampara de techo
 Потолочный светильник

 Parete - soffitto
 Wall - Ceiling
 Applique - Plafonnier
 Wand- Deckenleuchte
 Настенный/потолочный
 Applique y techo
 светильник



MADE IN ITALY

EGOLUCE s.r.l. Via I. Newton, 12 - 20016 Pero - Milano - Italy - Tel. +39 02339586.1 - Italia fax +39 023535112
Int. fax +39 0233911087 E-mail: info@egoluce.com - Int. E-mail: infoworld@egoluce.com www.egoluce.com